

POSTED

SEP 28 2021

Notice of Determination

Appendix D
ORANGE COUNTY CLERK-RECORDER DEPARTMENT

To:
[] Office of Planning and Research
For U.S. Mail:
P.O. Box 3044
Sacramento, CA 95812-3044
County Clerk
[] County of: Orange
Address: County Administration South Building
601 North Ross Street
Santa Ana, CA 92701

From:
BY: [Signature] DEPUTY
Public Agency: Irvine Ranch Water District
15600 Sand Canyon Avenue
Irvine, CA 92618
Jo Ann Corey, Environmental Compliance
Contact: Analyst
Phone: (949) 453-5300
Lead Agency (if different from above):
Address:
SEP 28 2021
Contact: HUGH NGUYEN, CLERK-RECORDER
Phone:
BY: [Signature] DEPUTY

FILED

SUBJECT: Filing of Notice of Determination in compliance with Section 21108 or 21152 of the Public Resources Code.

State Clearinghouse Number (if submitted to State Clearinghouse): 2011061038

Addendum No. 1 to the Initial Study/Mitigated Negative Declaration for the Orange Park Acres
Project Title: Well Replacement Project (SCH No. 2011061038)

Project Applicant: Irvine Ranch Water District

Project Location (include county): 678 North Gravier Street and 660 North Gravier Street (Assessor's Parcel Number 383-294-02) in the City of Orange, County of Orange

Project Description:

On February 6, 2020, the State Water Resources Control Board's Division of Drinking Water (DDW) issued revised drinking water Response Levels (RLs) of 10 parts per trillion (ppt) for perfluorooctanoic acid (PFOA) and 40 ppt for perfluorooctane sulfonate (PFOS). Notification Levels (NLs) for PFOA is set at 5.1 ng/L and 6.5 ng/L for PFOS. Further, on March 5, 2021 DDW issued a drinking water NL and RL of 0.5 parts per billion (ppb) and 5 ppb, respectively for perfluorobutane sulfonic acid (PFBS). While PFAS has been detected in IRWD's Well OPA-1, IRWD had previously removed this well from service in 2018, before the new, revised DDW standards were announced. The proposed Project is the construction of a water treatment system for the removal of per- and polyfluoroalkyl substances (PFAS)—more specifically PFOA and PFOS—from the groundwater extracted by the Well OPA-1. Additionally, the water treatment system would have the ability to treat PFBS, if needed. The project will treat groundwater from Well OPA-1 to ensure compliance with State NL and RL levels for PFAS and PFBS. An Addendum to the Initial Study/Mitigated Negative Declaration for the Orange Park Acres Well Replacement Project has been prepared for this Project.

This is to advise that the Irvine Ranch Water District has approved the above ([X] Lead Agency or [] Responsible Agency)

described project on 09/27/2021 and has made the following determinations regarding the above (date)

described project.

- 1. The project [] will [X] will not have a significant effect on the environment.
2. [] An Environmental Impact Report was prepared for this project pursuant to the provisions of CEQA.
[X] A Negative Declaration was prepared for this project pursuant to the provisions of CEQA.
3. Mitigation measures [X] were [] were not made a condition of the approval of the project.
4. A mitigation reporting or monitoring plan [X] was [] was not adopted for this project.
5. A statement of Overriding Considerations [] was [X] was not adopted for this project.
6. Findings [] were [X] were not made pursuant to the provisions of CEQA.

Authority cited: Section 21083, Public Resources Code.
Reference Section 21000-21174, Public Resources Code.

Revise

30-09/28/2021 - 0791

Recorded in Official Records, Orange County, Hugh Nguyen, Clerk-Recorder



202185000813 8:49 am 09/28/21

383 304A Z01

0.00 50.00 0.00 0.00 0.00 0.00 0.00 0.00

This is to certify that the final EIR with comments and responses and record of project approval, or the negative Declaration, is available to the General Public at:

www.irwd.com

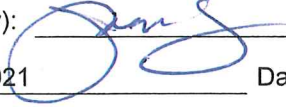
Signature (Public Agency):  Title: Environmental Compliance Analyst

Date: September 28, 2021 Date Received for filing at OPR: _____

FILED

SEP 28 2021

HUGH NGUYEN, CLERK-RECORDER

BY:  DEPUTY

POSTED

SEP 28 2021

ORANGE COUNTY CLERK-RECORDER DEPARTMENT

BY:  DEPUTY

**Addendum No. 1 to the Initial Study/Mitigated
Negative Declaration for the Orange Park
Acres Well Replacement Project
(SCH No. 2011061038)**

Prepared for | Irvine Ranch Water District
15600 Sand Canyon
Irvine, California 92618

Prepared by | Psomas
5 Hutton Centre Drive, Suite 300
Santa Ana, California 92707-8794
T: 714.751.7373

September 3, 2021

TABLE OF CONTENTS

<u>Section</u>		<u>Page</u>
Section 1.0	Introduction	1
	1.1 Purpose of the Document.....	1
	1.2 Basis for The Addendum	1
Section 2.0	Project Background	3
	2.1 Orange Park Acres Well Replacement Project Initial Study/Mitigated Negative Declaration.....	3
Section 3.0	Project Description and Setting.....	5
	3.1 Project Location	5
	3.2 Existing Site Conditions	5
	3.3 Modified Project Description	5
	3.4 Discretionary Approvals.....	6
	3.5 Permits.....	7
Section 4.0	Environmental Analysis.....	8
	4.1 Aesthetics	8
	4.2 Agriculture and Forestry Resources	12
	4.3 Air Quality	14
	4.4 Biological Resources	20
	4.5 Cultural Resources	23
	4.6 Energy	26
	4.7 Geology and Soils.....	28
	4.8 Greenhouse Gas Emissions.....	32
	4.9 Hazards and Hazardous Materials	35
	4.10 Hydrology and Water Quality.....	39
	4.11 Land Use and Planning	44
	4.12 Mineral Resources.....	46
	4.13 Noise	48
	4.14 Population and Housing.....	62
	4.15 Public Services	64
	4.16 Recreation	66
	4.17 Transportation.....	67
	4.18 Tribal Cultural Resources	70
	4.19 Utilities and Service Systems	72
	4.20 Wildfire.....	77
	4.21 Mandatory Findings of Significance.....	79

Section 5.0	Conclusions	81
Section 6.0	References	83

LIST OF TABLES

<u>Table</u>	<u>Page</u>
4-1	South Coast Air Quality Management District Air Quality Significance Thresholds 15
4-2	Estimated Maximum Daily Construction Emissions (lbs/day) 16
4-3	Maximum Localized Construction Pollutant Emissions (lbs/day) 17
4-4	GHG Emissions From Project Implementation..... 33
4-5	Noise Levels For Common Events..... 49
4-6	Estimated Constructlon Noise Levels at Receptors 55
4-7	Vibration Damage Threshold Criteria 57
4-8	Vibration Annoyance Thresholds 57
4-9	Vibration Levels for Construction Equipment 58
4-10	Estimated Vibration Levels at Nearest Receptors..... 59

EXHIBITS

<u>Exhibit</u>	<u>Follows Page</u>
2-1	Regional Location and Local Vicinity Map 3
3-1	Aerial Photograph 5
3-2	Site Master Plan..... 6
4-1	Existing Views 9
4-2	Existing Views 9
4-3	Existing Views 9

LIST OF APPENDICES

Appendix

A	CalEEMod Calculations
B	EDR Hazardous Materials Database Report
C	Geotechnical Baseline and Design Report
D	Noise Calculations
E	Basis of Design Report – Final
G	OCWD and IRWD Model Simulations Technical Memorandum

ACRONYM LIST

NAB	Assembly Bill
AQMP	Air Quality Management Plan
BAU	Business As Usual
BMPs	best management practices
CAAQS	California Ambient Air Quality Standards
CAL FIRE	California Department of Forestry and Fire Protection
CalEEMod	California Emissions Estimator Model
CalEPA	California Environmental Protection Agency
Caltrans	California Department of Transportation
CARB	California Air Resources Board
CBC	California Building Code
CDPH	California Department of Public Health
CEQA	California Environmental Quality Act
CERS	California Environmental Reporting System
CO	carbon monoxide
CRHR	California Register of Historic Resources
DAMP	Drainage Area Management Plan
dB	decibel
dBA	A-weighted decibel scale
DDW	Division of Drinking Water
DLRP	Division of Land Resource Protection
DTSC	Department of Toxic Substance Control
EA	Environmental Assessment
EDR	Environmental Data Resources
EFZ	Earthquake Fault Zone
EIR	Environmental Impact Report
EO	Executive Order
ft	feet
GHG	greenhouse gas emissions
GWMP	Groundwater Management Plan
HP	horsepower
HVAC	heating, ventilation, and air conditioning
in/sec	inches per second
IRWD	Irvine Ranch Water District
IS/MND	Initial Study/Mitigated Negative Declaration
km/hr	kilometers per hour
kWh	kilowatt hours
kWh/yr	kilowatt hours per year
lbs/day	pounds per day
LDR	Low Density Residential
L _{eq}	equivalent noise level

L _{max}	highest A-weighted sound levels
L _{min}	lowest A-weighted sound levels
LIP	Local Implementation Plan
LOS	Level of Service
LST	localized significance threshold
LUST	Leaking Underground Storage Site
m	meter
MBTA	Migratory Bird Treaty Act
MM	mitigation measure
mph	miles per hour
MTCO ₂ e/yr	metric tons of carbon dioxide equivalent per year
NAAQS	National Ambient Air Quality Standards
NCCP/HCP	Natural Community Conservation Plan and Habitat Conservation
NLs	Notification Levels
NO ₂	nitrogen dioxide
NO _x	nitrogen oxides
NPDES	National Pollutant Discharge Elimination System
NRHP	National Register of Historic Places
OC San	Orange County Sanitation District
OCFCD	Orange County Flood Control Department
OCWD	Orange County Water District
OPA	Orange Park Acres
PEIR	Program Environmental Impact Report
PFBS	perfluorobutane sulfonic acid
PFAS	polyfluoroalkyl substances
PFOS	perfluorooctane sulfonate
PM ₁₀	respirable particulate matter 10 microns or less in diameter
PM _{2.5}	fine particulate matter 2.5 microns or less in diameter
ppv	peak particle velocity
RCRA LQ HW	Resource Conservation and Recovery Act Large Quantity Hazardous Waste
RLs	Response Levels
rms	root mean square
RTP/SCS	Regional Transportation Plan/Sustainable Communities Strategy
SAMP	Sub-Area Master Plan
SARWQCB	Santa Ana Regional Water Quality Control Board
SCAG	Southern California Association of Government
SCAQMD	South Coast Air Quality Management District
SCCIC	South Central Coast Information Center
SO _x	sulfur oxides
SR	State Route
SRA	Source Receptor Area
SWPPP	stormwater pollution prevention plan
TAC	toxic air contaminant

USEPA	United States Environmental Protection Agency
USFWS	U.S. Fish and Wildlife Service
UST	Underground Storage Tank
VHFHSZ	Very High Fire Hazard Severity Zones
VOC	volatile organic compound

This page intentionally left blank

SECTION 1.0 INTRODUCTION

1.1 PURPOSE OF THE DOCUMENT

On June 11, 2012, the Board of Directors of the Irvine Ranch Water District (IRWD) adopted the *Orange Park Acres Well Replacement Project Initial Study/Mitigated Negative Declaration* (State Clearinghouse No. 2011061038) (hereinafter referred to as the “Approved Project”) which evaluated the environmental impacts associated with the destruction of a groundwater well, named Well Orange Park Acres (OPA)-3; and the construction, installation, and operation of a replacement well (Well OPA-1) with ancillary equipment and facilities located on the same site at 678 North Gravier Street in the City of Orange.

This document is an Addendum to the *Orange Park Acres Well Replacement Project Initial Study/Mitigated Negative Declaration*, as amended, and discussed in Section 2.0 Project Background. On February 6, 2020, the State Water Resources Control Board, the Division of Drinking Water (DDW) issued revised drinking water Response Levels (RLs) of 10 parts per trillion (ppt) for perfluorooctanoic acid (PFOA) and 40 ppt for perfluorooctane sulfonate (PFOS). Notification Levels (NLs) for PFOA is set at 5.1 ng/L and 6.5 ng/L for PFOS. Further, on March 5, 2021 DDW issued a drinking water notification level and response level of 0.5 parts per billion (ppb) and 5 ppb, respectively for perfluorobutane sulfonic acid (PFBS).

The proposed Project (hereinafter referred to as the “Modified Project”) is the construction of a water treatment system for the removal of per- and polyfluoroalkyl substances (PFAS)—more specifically PFOA and PFOS—from the groundwater extracted by the Well OPA-1. Additionally, the water treatment system would have the ability to treat PFBS if needed. Current levels of PFBS at Well OPA-1 are substantially lower than the State NL and RL levels. The goal of the water treatment system is to treat groundwater from Well OPA-1 to “non-detect” levels of PFAS and PFBS and ensure compliance with State NL and RL levels. The new treatment facility is planned to be constructed on IRWD’s current well site at 678 North Gravier Street and on an adjacent IRWD-owned property at 660 North Gravier Street, both located in the City of Orange.

Section 1.0 of this Addendum provides an introduction and the basis for the addendum. Section 2.0 provides background information on the previously Approved Project, including actions taken by IRWD. Section 3.0 provides a description of the proposed Project or Modified Project. Section 4.0 presents an environmental analysis of the Modified Project. Section 5.0 presents the findings related to the environmental analysis of the Modified Project. Section 6.0 identifies references of the original resources cited in this Addendum.

1.2 BASIS FOR THE ADDENDUM

This Addendum has been prepared in accordance with the provisions of the California Environmental Quality Act (CEQA) (*California Public Resources Code* §21000 et seq.) and the State CEQA Guidelines (Title 14, *California Code of Regulations* §15000 et seq.). Pursuant to Section 15050 of the State CEQA Guidelines, IRWD is the lead agency for this Addendum and has the authority for Project approval and approval of the accompanying environmental documentation (i.e., this Addendum).

Section 15164(b) of the CEQA Guidelines states that “an addendum to an adopted negative declaration may be prepared if only minor technical changes or additions are necessary or none of the conditions described in Section 15162 calling for the preparation of a subsequent

Environmental Impact Report (EIR) or negative declaration have occurred.” Pursuant to Section 15162(a) of the CEQA Guidelines, a subsequent EIR is only required when:

- (1) Substantial changes are proposed in the project which will require major revisions of the previous EIR or Negative Declaration due to the involvement of new significant environmental effects or a substantial increase in the severity of previously identified significant effects;
- (2) Substantial changes occur with respect to the circumstances under which the project is undertaken which will require major revisions of the previous EIR or Negative Declaration due to the involvement of new significant environmental effects or a substantial increase in the severity of previously identified significant effects; or
- (3) New information of substantial importance, which was not known and could not have been known with the exercise of reasonable diligence at the time the previous EIR was certified as complete or the Negative Declaration was adopted, shows any of the following:
 - (A) The project will have one or more significant effects not discussed in the previous EIR or negative declaration;
 - (B) Significant effects previously examined will be substantially more severe than shown in the previous EIR;
 - (C) Mitigation measures or alternatives previously found not to be feasible would in fact be feasible, and would substantially reduce one or more significant effects of the project, but the project proponents decline to adopt the mitigation measure or alternative; or
 - (D) Mitigation measures or alternatives which are considerably different from those analyzed in the previous EIR would substantially reduce one or more significant effects on the environment, but the project proponents decline to adopt the mitigation measure or alternative.

This Addendum analyzes the environmental impacts resulting from implementation of the Modified Project (including impacts resulting from changes in circumstances) and identifies the difference, if any, between the impacts evaluated with the Approved Project, and those that would be associated with the Modified Project. It also reviews whether any new information of substantial importance has been identified that shows that the Modified Project would have one or more significant effects not discussed in the previous environmental document.

As described in detail herein, an analysis has been conducted that confirms there are no new significant impacts resulting from the Modified Project, nor is there any substantial increase in the severity of any previously identified environmental impacts. The potential impacts associated with the Modified Project would either be the same or less than the anticipated levels described in the Approved Project. Therefore, in accordance with Section 15164 of the CEQA Guidelines, an Addendum to the previously approved *Orange Park Acres Well Replacement Project Initial Study/Mitigated Negative Declaration* is the appropriate environmental documentation for the Modified Project.

SECTION 2.0 PROJECT BACKGROUND

Irvine Ranch Water District (IRWD) is the Lead Agency responsible for the *Orange Park Acres Well Replacement Project Initial Study and Mitigated Negative Declaration* and the subject *Addendum to the Initial Study/Mitigated Negative Declaration for the Orange Park Acres Well Replacement Project*. The proposed or Modified Project would be implemented on the site of the Approved Project site located at 678 North Gravier Street and on an additional IRWD adjacent property located at 660 North Gravier Street in the City of Orange, as shown on Exhibit 2-1, Regional Location and Local Vicinity Map. The following section provides a summary of the adopted *Orange Park Acres Well Replacement Project Initial Study/Mitigated Negative Declaration (IS/MND)* that is integral to the Modified Project.

2.1 ORANGE PARK ACRES WELL REPLACEMENT PROJECT INITIAL STUDY/MITIGATED NEGATIVE DECLARATION

IRWD adopted an IS/MND for the *Orange Park Acres Well Replacement Project* on June 11, 2012 (State Clearinghouse No. 2011061038). In August 2010, a Sub-Area Master Plan (SAMP) was prepared by IRWD which identified the need for upgrades and improvements to meet existing and future demands of the Orange Park Acres (OPA) service area. Identified in the SAMP was Well OPA-3, an existing groundwater well approaching the end of its useful life. The Approved Project included the destruction and abandonment of Well OPA-3 and the drilling, construction, and operation of a new replacement well, Well OPA-1 on the same site located at 678 North Gravier Street in the City of Orange. A brief summary from the IS/MND of the destruction and abandonment of Well OPA-3 and the construction of Well OPA-1 is provided below.

The Well OPA-3 chlorine disinfection system was proposed to be removed and replaced with a new system. The new onsite disinfection system would be similar to the existing disinfection facility and would use chloramination to disinfect the groundwater pumped by the well prior to delivery of the water into the existing distribution system. The disinfection system would consist of two tanks—one tank would contain the 12.5% sodium hypochlorite (approximately 2,500 gallons) and the other tank would contain the 29% ammonia (approximately 200 gallons). Additionally, a wet well and pump station would be constructed on site to receive and deliver water from IRWD Well OPA-1. The associated pump station would then pump the disinfected well water to IRWD's Santiago Hills Zone 5 Reservoir, where releases would then be made to meet an average demand of approximately 900 acre-feet per year of potable water to the OPA service area, which is based on the OPA SAMP. Other ancillary facilities would include, but are not limited to, electrical panels, radio mast, Supervisory Control and Data Acquisition/Programmable Logic Controller, meters, valves, sand separator, chemical tanks, and enclosures for various facilities.

The destruction and abandonment of Well OPA-3 would include filling with either cement grout, or bentonite grout, and cutting and capping the upper several feet of well casing. The final site conditions involving the construction and operation of Well OPA-1 were proposed to be very similar to the conditions found with the operation of Well OPA-3. Once Well OPA-1 is constructed, IRWD would perform daily well inspection and maintenance at the Project site consistent with the existing conditions.

The IS/MND determined that impacts to all environmental topics were less than significant except for impacts related to biological resources, geology and soils, noise, and transportation/traffic. **Mitigation Measure (MM) BIO-1** was incorporated to comply with the Migratory Bird Treaty Act (MBTA) and to reduce impacts to nesting birds to less than significant. Impacts related to lateral spreading, liquefaction, and subsidence would be reduced to less than significant with

D:\Projects\3\IRW\001102\MXD\Addendum\ex_RL_LV_20210713.mxd

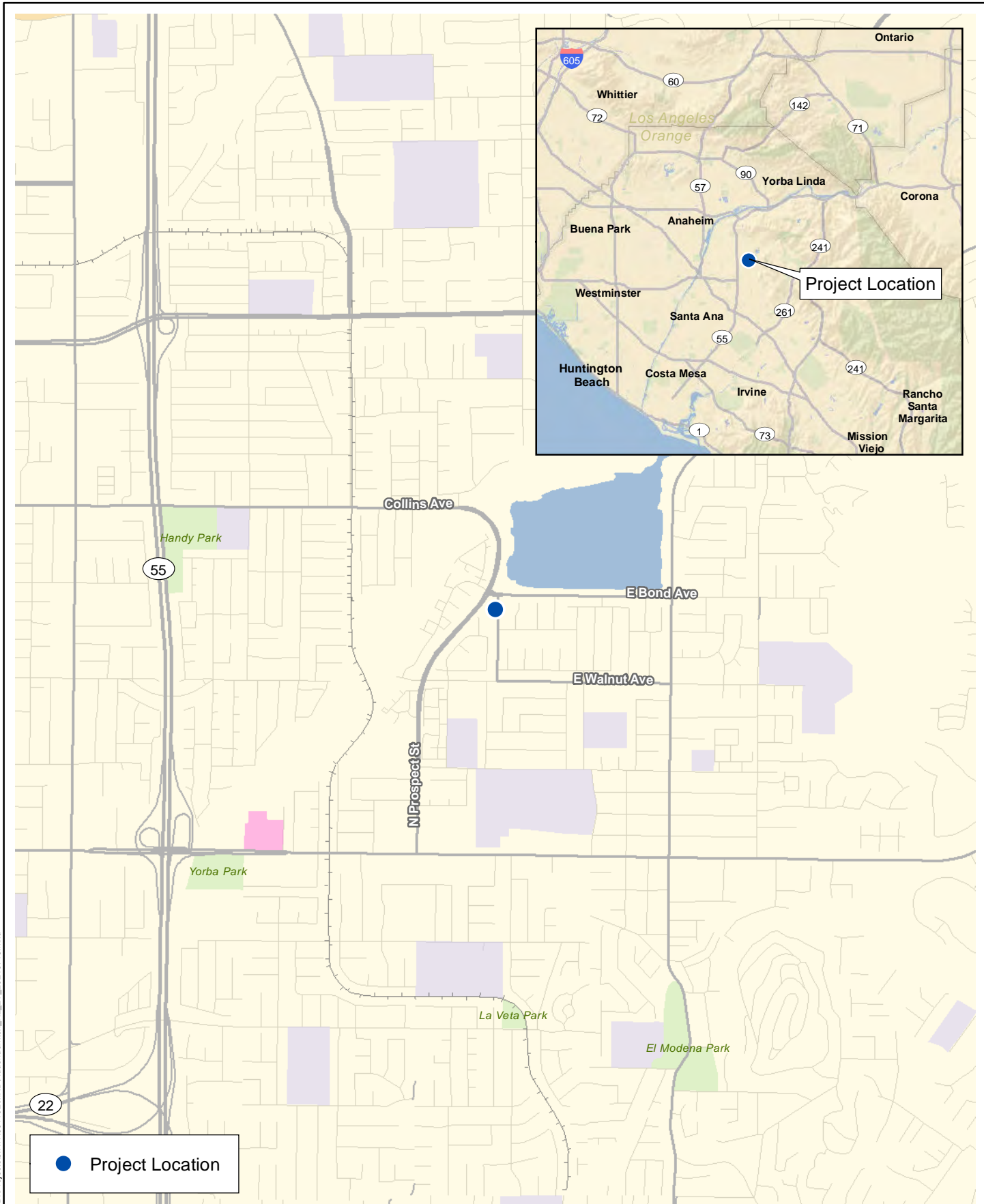

● Project Location

Regional Location and Local Vicinity Map

Orange Park Acres Well Replacement Project

Exhibit 2-1

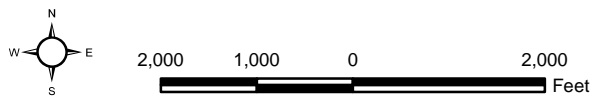

implementation of **MM GEO-1** which requires preconstruction geotechnical assessments to characterize the soils to be encountered in and around each project component and to determine the site-specific design criteria to reduce potential risks of project construction and operation. With incorporation of **MM NOI-1**, **MM NOI-2**, and **MM NOI-3**, temporary and permanent impacts associated with construction and operational noise impacts to neighboring sensitive receptors at the proposed well would be less than significant. Impacts related to construction generated traffic on area traffic volumes would be less than significant; however, the IS/MND identified that impacts would be further reduced with implementation of **MM TR-1** which includes specifications regarding construction signing, vehicular traffic control, pedestrian traffic control and safety, access to adjacent properties, and permanent traffic control devices to reduce transportation impacts associated with construction.

SECTION 3.0 PROJECT DESCRIPTION AND SETTING

3.1 PROJECT LOCATION

The Modified Project site (Assessor's Parcel Number 383-294-02) is located at 678 North Gravier Street and 660 North Gravier Street in the City of Orange as shown on Exhibit 2-1, Regional Location and Local Vicinity Map. Regional access to the sites is from State Route (SR) 55 Freeway (0.9 mile to the west) via Walnut Avenue to North Gravier Street. Santiago Creek is within 0.25 mile of the project site to the west, and the Santiago Creek Recharge Basin which is operated by the Orange County Water District (OCWD) is about 300 feet to the north–northeast.

3.2 EXISTING SITE CONDITIONS

The Project site is in a developed and urbanized area of the City of Orange, east of SR-55 as shown on Exhibit 3-1, Aerial Photograph. The Project site is surrounded by single-family residences. Specifically, the site is adjacent to single-family residences and North Prospect Street to the west; a two-story residence, East Bond Avenue, and the Santiago Creek Recharge Basin to the north; North Gravier Street and single-family residences to the east; and single-family residences to the south. The 0.76-acre Project site is currently fully developed with a 16,000 square foot (sf) IRWD water facility and asphalt maintenance courtyard located at 678 North Gravier Street and an IRWD-owned single-story residential structure located at 660 North Gravier Street. The site is relatively flat; elevations on site are approximately 290 feet above mean sea level. Minimal landscaping is present by the North Gravier Street entrance to the IRWD facility.

The Project site at 678 North Gravier Street contains a surge tank within a recessed pit; two single-story buildings which enclose the well, pumps, a disinfection system, staff facilities; and associated support infrastructure and appurtenances for the Well OPA-1, an asphalt maintenance yard, masonry walls on the east and west sides of the property, one wooden fence on the south side of the property, and an iron pedestrian/vehicle gate along with various landscaping facing North Gravier Street. Current access via the pedestrian/vehicle gate to the site is west of North Gravier Street and approximately 70 feet south of East Bond Avenue. The adjacent IRWD-owned property at 660 North Gravier Street is an unoccupied single-family residence with garage, a wooden fence to the north of the property (mentioned previously), and a wooden fence south and adjacent to the garage enclosing a back yard. Landscaping surrounds the property. Approximately 9,000 sf (29%) of the Project site contains impervious surfaces (i.e., buildings, building pads, concrete, asphalt), while the rest is pervious surfaces (i.e., lawn, dirt, trees, gravel).

According to the City of Orange General Plan, the land use designation of the site is Low Density Residential (LDR). Per the City of Orange Zoning Ordinance, the Project site is zoned R-1-7 Single Family Residential with a 7,000 sf minimum lot size. Exhibits 4-1 through 4-3, depict existing views of the Project site and the surrounding area.

3.3 MODIFIED PROJECT DESCRIPTION

As discussed previously in Section 1.0 Introduction, the DDW issued revised drinking water RLs of 10 ppt for PFOA and 40 ppt for PFOS. While PFAS has been detected in IRWD's Well OPA-1, IRWD had previously removed this well from service in September 2018—before the new revised DDW standards were promulgated. Well OPA-1 will remain out of service until the PFAS mitigation strategy is implemented and the new removal system is operational.

D:\Projects\3IRW\001102\MXD\Addendum\ex_Aerial_20210713.mxd

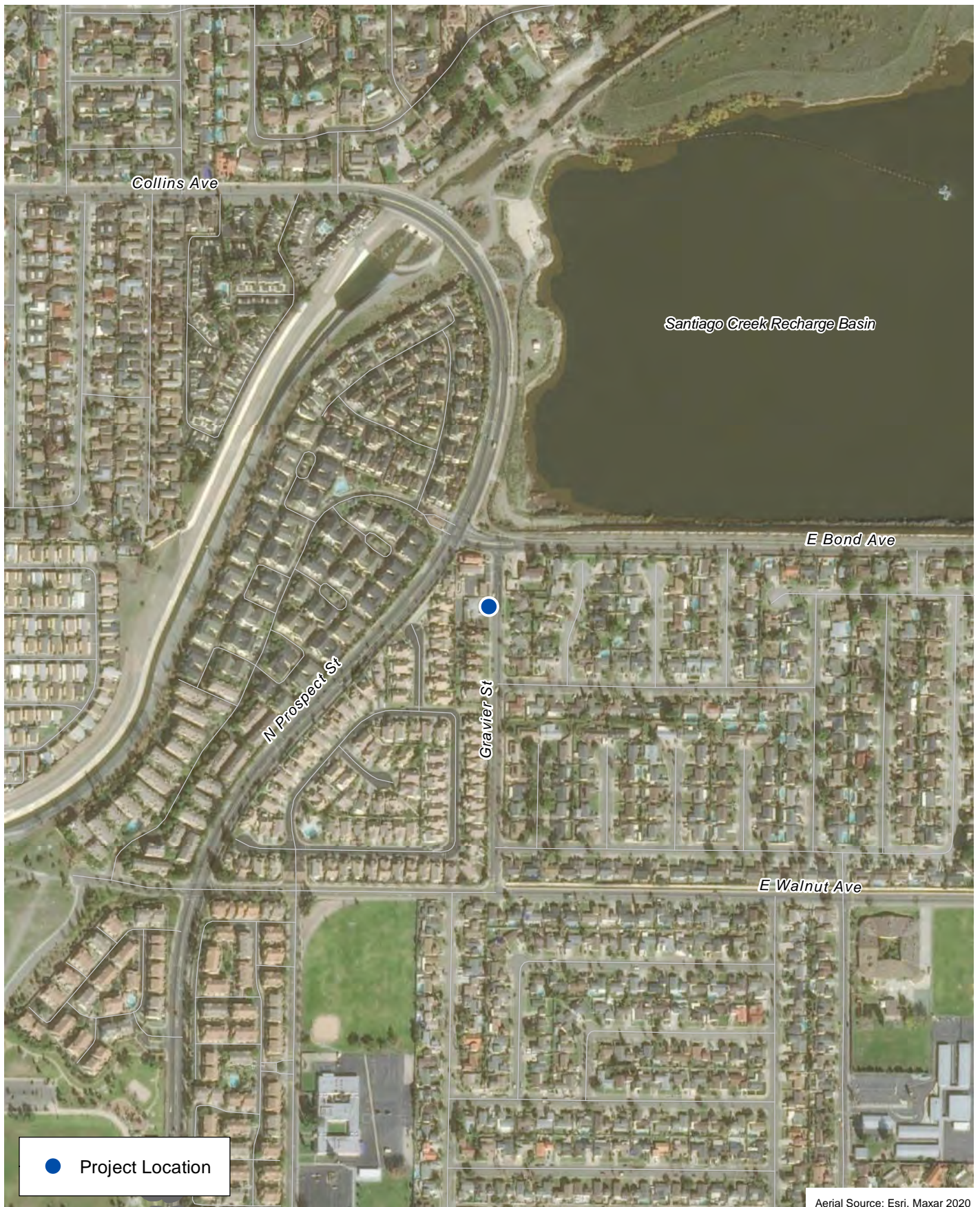

● Project Location

Aerial Source: Esri, Maxar 2020

Aerial Photograph

Orange Park Acres Well Replacement Project

Exhibit 3-1

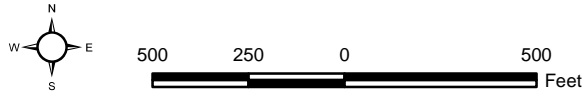

The Modified Project involves the construction of a wellhead treatment system for the removal of PFAS—more specifically PFOA and PFOS—from the groundwater extracted by the Well OPA-1. The new treatment facilities are planned to be constructed adjacent to the existing Well OPA-1 site on IRWD’s properties at 678 and 660 North Gravier Street in the City of Orange. The new treatment system will be designed to remove PFAS concentration to non-detect levels prior to distribution of the treated water. Therefore, the treated water will be below the recommended maximum NLs and RLs recommended by the DDW.

The Modified Project includes (1) allowing Well OPA-1 to increase production volumes up to 3,200 acre-feet per year (AFY); (2) allowing IRWD to serve groundwater produced at Well OPA-1 throughout its entire drinking water system.; (3) demolishing an existing IRWD-owned single-family residence to extend the operational area to include the entire IRWD-owned property at 678 North Gravier Street in the City of Orange; and (4) construction of on-site water treatment systems, such as ion exchange resins, to remove PFAS from the groundwater produced at Well OPA-1. Exhibit 3-2, Site Master Plan depicts details of the Modified Project.

3.3.1 ACCESS AND CIRCULATION

The Modified Project would construct a new access driveway on the east side of the facility facing North Gravier Street. The new driveway would be a similar size to the driveway to the current well facility between Building “A” and “B” and would be constructed per the City of Orange standards and regulations. The driveway is proposed to be 30-foot wide and located south of the existing well facility driveway. The driveway would provide direct access to the Project site, and the location and size of the driveway would provide truck access to and from the site for ion exchange resin changeouts and other various maintenance functions.

3.3.2 CONSTRUCTION

Construction of the Modified Project would generate temporary trips associated with construction activities. Construction-related traffic would primarily be associated with delivery of building materials and construction equipment, removal of construction debris, and construction workers commuting to/from the Project site. Weather permitting, construction is planned to begin in February 2022 with the demolition of the existing single-story residence and the construction of the water treatment system and associated infrastructure. It is expected that the construction of the Modified Project will be completed at the end of 2022.

3.4 DISCRETIONARY APPROVALS

Pursuant to CEQA, IRWD has primary discretionary authority over the approval of the Modified Project. The anticipated discretionary approvals required for IRWD to implement the Project includes the following:

- Adoption of the Addendum to the Orange Park Acres Well Replacement Project IS/MND;
- Adoption of a mitigation monitoring and reporting program; and
- Design, construction, and operation of the project.

OCWD, as a Responsible Agency would have discretionary approval for the following:

- Approve the IRWD Engineer’s Report
- Authorize Publication of Notice of Inviting Bids for the construction of the proposed Project

D:\Projects\3IRW001102\Graphics\Addendum\ex_Site_Master_Plan_20210714.ai

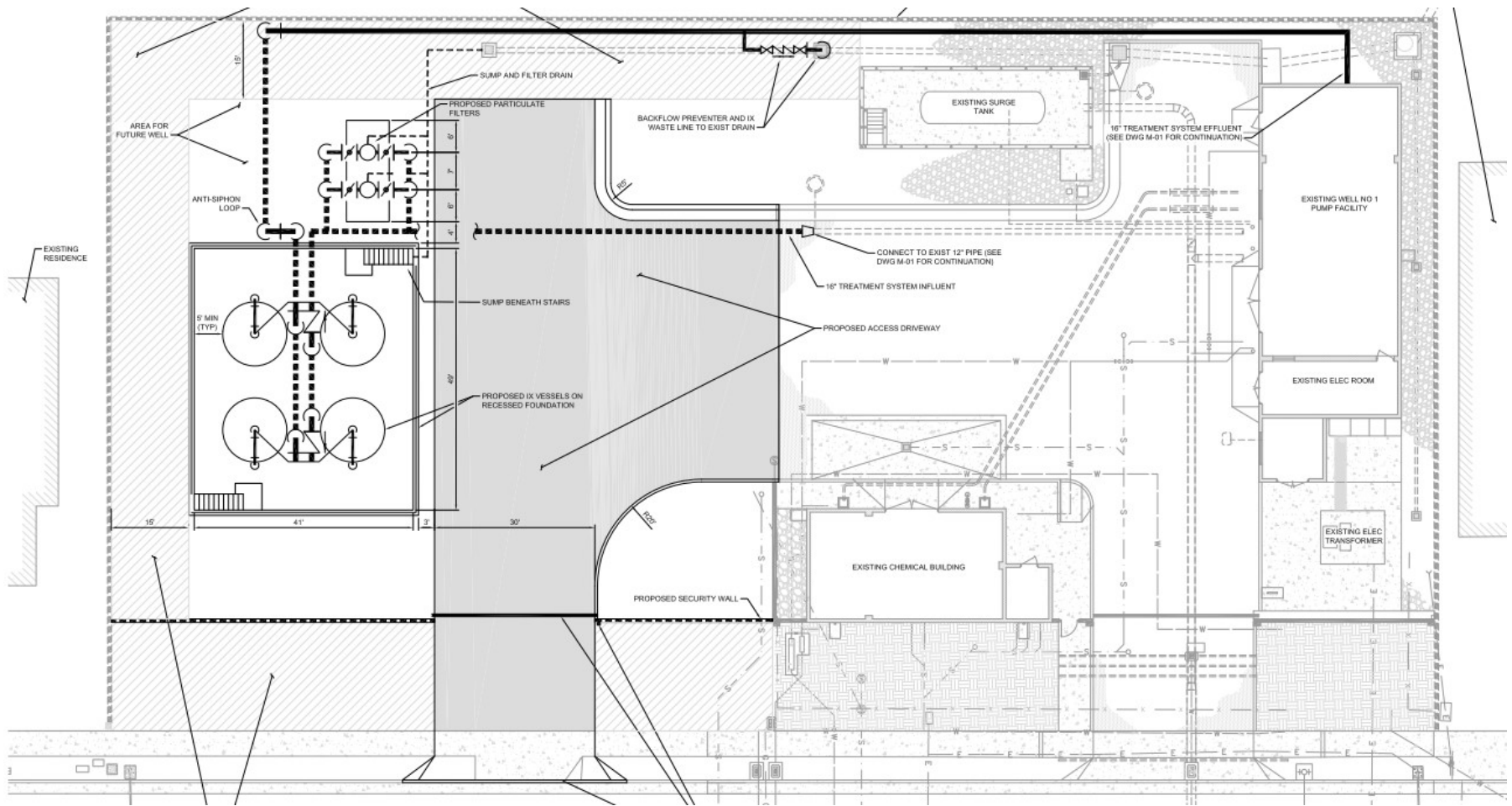

Source: AECOM, May 2021

Site Master Plan

Orange Park Acres Well Replacement Project

Exhibit 3-2



Other public agencies may also have discretionary authority over the Project, or aspects of the Project, and are considered responsible agencies, including OCWD listed above. The IS/MND can be used by the responsible agencies to comply with CEQA in connection with permitting or approval authority over the Project.

3.5 PERMITS

3.5.1 STATE WATER RESOURCES CONTROL BOARD, THE DIVISION OF DRINKING WATER

IRWD would obtain approvals from the DDW, previously known as the California Department of Public Health, for the water treatment system. The DDW will require an amendment to IRWD's existing Water Supply Permit dated April 24, 1980 to add the water treatment system for the IRWD Well OPA-1.

3.5.2 SANTA ANA REGIONAL WATER QUALITY CONTROL BOARD

Dewatering may be required during proposed project construction. A region-specific permit is available from the Santa Ana Regional Water Quality Control Board (SARWQCB) allowing IRWD and its contractors to discharge groundwater resulting from construction projects (Order No. R8-2009-0003, NPDES No. CAG998001).

3.5.3 CITY OF ORANGE

IRWD will obtain an encroachment permit from the City of Orange for work in the public right of way to construct the new driveway. The City of Orange Public Works has confirmed no other permit will be required including demolition.

SECTION 4.0 ENVIRONMENTAL ANALYSIS

This document is an addendum to the CEQA document outlined in Section 2.0, Project Background. By definition, an addendum to a CEQA document is intended to demonstrate that the modifications/alterations to the previously Approved Project will not substantially increase environmental impacts or create any new significant impacts. The following analysis is documentation of why and how this conclusion has been made.

This section of the Addendum examines each environmental topical issue identified in the State CEQA Guidelines Environmental Checklist and the City of Orange Environmental Checklist, specific to the Modified Project. The topical areas identified in the *Orange Parks Acres Well Replacement Project IS/MND* were used as guidance for this Addendum. The Addendum includes additional areas of analysis, including analysis of impacts to energy and wildfire hazards, pursuant to the 2018 amendments to the State CEQA Guidelines. However, the Addendum does not include tribal cultural resources. Assembly Bill (AB) 52 became effective on July 1, 2015, after the IS/MND was certified. AB 52 requires that tribal cultural resources be evaluated under CEQA; however, AB 52 consultation does not apply since the environmental document is not a Negative Declaration, an MND, or an EIR. The Environmental Checklist has been subsequently revised to reflect these amendments.

For each section, brief summaries of the findings of *Orange Park Acres Well Replacement Project IS/MND* are provided. This comparative analysis provides IRWD with the factual basis for determining if any changes in the Project, any changes in circumstances, or any new information since the *Orange Park Acres Well Replacement Project IS/MND* was adopted require additional environmental review or preparation of a subsequent or supplemental MND.

4.1 AESTHETICS

4.1.1 SUMMARY OF PREVIOUS ENVIRONMENTAL ANALYSIS

Orange Park Acres Well Replacement Project Initial Study/Mitigated Negative Declaration

As set forth in the IS/MND prepared for the Orange Park Acres Well Replacement Project, the Approved Project would not have significant impact related to aesthetics. The Approved Project would not have an adverse on a scenic vista nor would it substantially damage scenic resources. It was determined that the site is not designated as a scenic vista in the City of Orange. Further, no State scenic highways or viewscape corridors were identified adjacent to or in the vicinity of the Project site.

The IS/MND determined the proposed Project would involve construction. Construction and operation activities would be within the boundaries of the existing IRWD property and would be shielded by construction fencing that would screen the majority of the views of the Project site from the surrounding neighborhood. The scale and height of the proposed treatment facilities would be similar to the existing Well OPA-3 facilities and enclosures and fencing/masonry walls would be designed to significantly screen views of the Project from the neighborhood. Therefore, the construction and operation of the proposed Project would not substantially degrade the existing visual character or quality of the Project site or surrounding area.

Lastly, it was determined that the Approved Project would utilize and install lighting similar to the existing conditions. Construction and operational security lighting would be shielded so traffic and adjacent property owners would not experience substantial impacts due to light and glare. Further,

Project operations would not introduce a new substantial source of light or glare to the Project area.

4.1.2 PROJECT ENVIRONMENTAL REVIEW

Would the project:

a) Have a substantial adverse effect on a scenic vista?

No Substantial Change from Previous Analysis. The City of Orange is characterized by scenic vistas including undeveloped hillsides, ridgelines, and open space areas including a viewscape corridor in the eastern portion of the City of Orange. Consistent with the previous analysis for the Approved Project and according to Figure 5.1-1 of the City of Orange General Plan Program EIR (PEIR), there are no designated scenic vistas or viewscape corridors at or near the Project site (Orange 2010). The Approved Project site is surrounded by one- and two-story residential houses. The topography of the Project site is flat and is currently developed with the existing Well OPA-1, associated infrastructure, and asphalt surrounded by masonry walls, iron and wood fencing, an iron entrance/exit gate, and minimal landscaping.

During construction of the Modified Project, the Project site would be surrounded by temporary fence that would reduce visibility of construction. Upon completion of construction activities, a new permanent perimeter fence and new gate would be constructed similar in scale, height, and visual appearance and with the existing site features, and compatible with the surrounding residential neighborhood. Therefore, the Modified Project would not create a new significant impact pertaining to scenic vistas that was not previously analyzed, and no mitigation measures are required.

b) Substantially damage scenic resources, including, but not limited to, trees, rock outcroppings, and historic buildings within a state scenic highway?

No Substantial Change from Previous Analysis. Consistent with the previous analysis for the Approved Project, there are no officially designated State scenic highways in the City of Orange or in the vicinity of the Modified Project (Caltrans 2018). Furthermore, as discussed in Response to Threshold 4.1.2. (a), no designated scenic views or viewscape corridors are within the vicinity of the site. Therefore, construction and operation of the proposed Modified Project would not substantially damage scenic resources along a State scenic highway, and no impact would occur.

c) In non-urbanized areas, substantially degrade the existing visual character or quality of public views of the site and its surroundings? (Public views are those that are experienced from publicly accessible vantage point). If the project is in an urbanized area, would the project conflict with applicable zoning and other regulations governing scenic quality?

A site visit was conducted on June 19, 2021. Exhibits 4-1 through 4-3, Existing Site Views, include photographs that depict the existing visual character of the Modified Project site. Brief descriptions of each view are provided below.

- **View 4-1a.** View looking north from North Gravier Street and approximately 25 feet south of the southern property line of the Modified Project site. To the northwest, the view depicts the single-story residence with garage and fence located at 660 North Gravier Street (in the foreground) and the on-site “A” building (in the background) located at 678 North Gravier Street. Additionally, the intersection of North Gravier Street and East Bond Avenue



4-1a. View looking North on North Gravier Street towards the IRWD-owned residence and Building “A”.



4-1b. View looking Northwest from Sidewalk on North Gravier of front of IRWD-owned residence and Building “A” on the right.

D:\Projects\3IRW001102\GRAPHICS\Addendum\ex_Exist\ew_1_20210816.ai

Existing Views

Orange Park Acres Well Replacement Project

Exhibit 4-1





4-2a. View looking Southwest from North Gravier Street and East Bond Street corner showing partial views of Building “A” on the left and Building “B” on the right.



4-2b. View looking South from North Gravier Street Sidewalk showing IRWD-owned residence.

D:\Projects\3IRW001102\Graphics\Addendum\ex_Exist\ew_2_20210816.ai

Existing Views

Orange Park Acres Well Replacement Project

Exhibit 4-2





4-3a. View looking West from across North Gravier Street showing partial views of Building "A" on the left, the existing gate/driveway entrance, and Building "B" on the right.

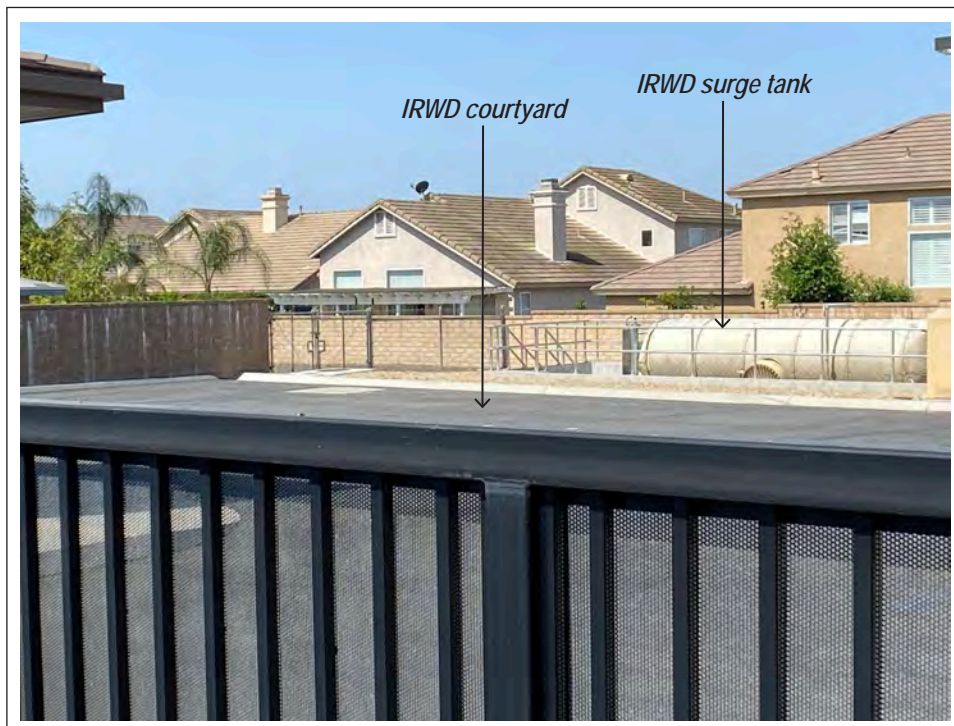

4-3b. View looking West from existing driveway on North Gravier Street showing the existing above-ground surge tank, asphalt courtyard, and fence to the left separately the facility and the IRWD-owned residence.

D:\Projects\3IRW001102\Graphics\Addendum\ex_Exist\ew_3_20210816.ai

Existing Views

Orange Park Acres Well Replacement Project

Exhibit 4-3



can be seen to the north. Street parking, utility poles, landscaping, and parked automobiles can be seen on the west and east side of North Gravier Street.

- **View 4-1b.** View looking northwest from the sidewalk on North Gravier Street. This view shows the front of the IRWD-owned single-story residence located at 660 North Gravier Street with fencing enclosing the backyard of the residence and landscaping in the front of the structure and east of the sidewalk. In the background, partial views of the roofs of two-story residences are located further west on North Prospect Avenue. To the northwest, past the residence is the IRWD-owned Building “A” and a masonry wall. To the north, further north behind the IRWD facility, is the roof of a two-story residence located on the corner of North Gravier Street and East Bond Avenue.
- **View 4-2a.** View looking southwest from the corner of North Gravier Street and East Bond Avenue. Views from this vantage point show the two-story residence to the north of the IRWD facility; partial views of on-site buildings “A” (on the south end of the site) and “B” (on the north end of the site); iron access gate and masonry walls; public sidewalks; street parking utility pole/lighting; and landscaping.
- **View 4-2b.** View looking south from the sidewalk on North Gravier Street of the IRWD-owned single-story residence located at 660 North Gravier Street, garage, and fence enclosing the backyard. Also visible is the driveway, landscaping, and the public sidewalk running south. Beyond the IRWD-owned residence, is a two-story private residence with mature trees and hedges next to the residence and in the distance.
- **View 4-3a.** View looking west from the corner of North Gravier Street and East Bond Avenue. Visible are two on-site buildings “A” (on the south end of the site) and “B” (on the north end of the site); iron access gate and masonry walls; asphalt driveway; maintenance courtyard; public sidewalk; and landscaping along North Gravier Street. Beyond the access gate is an above-ground surge tank (at the west end of the site) and further west behind the IRWD masonry wall are two-story residential structures located on North Prospect Street. .
- **View 4-3b.** This view is looking west from the existing IRWD driveway gate into the facility. Inside the courtyard, to the south, is a wooden fence dividing the existing facility and the IRWD-owned property located at 660 North Gravier Street. In the background, across the asphalt maintenance courtyard, is an above ground surge tank and two-story residences located on North Prospect Street.

No Substantial Change from Previous Analysis. The aerial photograph (Exhibit 3-1) shows the Modified Project site’s relationship to the surrounding land uses. The Modified Project site is located within an urbanized area surrounded by residential communities, existing IRWD facilities, and the OCWD Santiago Water Recharge Basin. According to the City of Orange General Plan Land Use Element, the land use designation of the site is LDR and is zoned R-1-7 Single Family Residential per the City of Orange Zoning Ordinance. Consistent with the previous analysis for the Approved Project, the Modified Project is consistent with the general plan and zoning designation because public utility facilities, such as water districts, are permitted in residential communities. Further, as discussed in Response to Threshold 4.1.2. (a), there are no designated scenic vistas or viewscales at or near the Project site and the scale and height of the Modified Project would be similar to the Approved Project. Architectural elements would be used on the Modified Project consistent with the Approved Project and compatible with the surrounding residential neighborhood.

Consistent with the previous analysis for the Approved Project, the Modified Project would not create a new significant impact pertaining to the existing visual character or quality of public views

of the Modified Project or its surroundings that was not previously analyzed, and no new mitigation measures are required.

d) Create a new source of substantial light or glare which would adversely affect day or nighttime views in the area?

No Substantial Change from Previous Analysis. Modified Project development would involve installation of lighting within the recessed concrete pit for the tank area. The new lighting source would be minimal and would be designed to direct illumination within the property for the tank area. Therefore, the Modified Project would not generate a new source of substantial glare adversely affecting nighttime views. Additionally, the new permanent perimeter fence and gate would be constructed of low-glare materials and would not substantially impact daytime views. Therefore, consistent with the previous analysis for the Approved Project, the Modified Project would not create a new source of substantial light or glare that would adversely affect day or nighttime views. No new significant impact would occur.

Conclusion

The impacts of the Modified Project would be consistent with the impacts identified for the previously Approved Project analyzed in the IS/MND. The Modified Project would not create a new significant impact or a substantial increase in the severity of previously identified effects. In regard to Section 15162 of the State CEQA Guidelines, the Modified Project (1) would not propose substantial changes; (2) would not have circumstantial changes when the Project is undertaken; and (3) would bring about no new information of substantial importance that would (a) create new significant impacts, (b) increase the severity of previously examined effects, or (c) determine that mitigation measures or alternatives previously found not to be feasible would, in fact, be feasible; or (4) introduce mitigation measures that are considerably different from those analyzed in the previous documents. For these reasons, no major revisions to the aesthetics analysis provided in the IS/MND are required.

Mitigation Program

No mitigation for aesthetics impacts was required in the IS/MND.

4.2 AGRICULTURE AND FORESTRY RESOURCES

4.2.1 SUMMARY OF PREVIOUS ENVIRONMENTAL ANALYSIS

Orange Park Acres Well Replacement Project Initial Study/Mitigated Negative Declaration

As discussed in the IS/MND, the Approved Project site is classified as “urban and built-up land” and does not contain land designated as Prime Farmland, Unique Farmland, or Farmland of Statewide Importance. The Approved Project site and lands within the vicinity of the Project are not used for agricultural purposes and are not under a Williamson Act contract. Further, the IS/MND stated that no land zoned as forest lands or timberlands exist within the Approved Project site or in the vicinity of the Approved Project site. Therefore, the proposed Project would not involve changes to the existing environment that would result in conversion of farmland to non-agricultural use or forestland to non-forest use. The Approved Project would not conflict with existing zoning for agriculture use or would not have an impact to forest lands or timberlands. No impact would occur, and no mitigation was identified.

4.2.2 PROJECT ENVIRONMENTAL REVIEW

Would the project:

- a) ***Convert Prime Farmland, Unique Farmland, or Farmland of Statewide Importance (Farmland), as shown on the maps prepared pursuant to the Farmland Mapping and Monitoring Program of the California Resources Agency, to non-agricultural use?***

No Substantial Change from Previous Analysis. Consistent with the previous analysis for the Approved Project, the Modified Project site is mapped as “Urban and Built-Up Land” not as farmland, on the California Important Farmland Finder maintained by the Division of Land Resource Protection (DLRP 2021). The site is currently fully developed and is not in agricultural use. Therefore, as with the Approved Project, the Modified Project would not convert farmland to non-agricultural use. No new impact would occur.

- b) ***Conflict with existing zoning for agricultural use, or a Williamson Act contract?***

No Substantial Change from Previous Analysis. As discussed in Response to Threshold 4.2.2. (a) the Modified Project site is located on a developed urban site within a developed urban area. The land is not zoned as A-1 Agriculture according to the City of Orange Zoning Map (Orange 2020). Further, while there are areas in the City of Orange zoned for agricultural uses, there are no lands within the City of Orange under a Williamson Act contract (Orange 2010). Therefore, consistent with the Approved Project, the Modified Project would not conflict with existing zoning for agricultural uses or a Williamson Act contract. No new impact would occur.

- c) ***Conflict with existing zoning for, or cause rezoning of, forest land (as defined in Public Resources Code section 12220(g)), timberland (as defined in Public Resources Code section 4526), or timberland zoned Timberland Production (as defined by Government Code section 51104(g))?***

No Substantial Change from Previous Analysis. Consistent with the previous analysis for the Approved Project, the Modified Project site is not zoned for forest land, timberland, or timberland production (Orange 2020). Therefore, consistent with the Approved Projects, the Modified Project would not conflict with such zoning, and no new impact would occur.

d) Result in the loss of forest land or conversion of forest land to non-forest use?

No Substantial Change from Previous Analysis. Minimal ornamental landscaping exists on the Project site and in the surrounding vicinity. The Modified Project site is not cultivated for forest resources and are not grown for forest resources. Consistent with the Approved Project, a significant impact would not occur, and no new impact would occur.

e) Involve other changes in the existing environment which, due to their location or nature, could result in conversion of Farmland, to non-agricultural use or conversion of forest land to non-forest use?

No Substantial Change from Previous Analysis. As discussed in Response to Threshold 4.2.2. (a-d), no agricultural land uses, forest land, or timberland exist on the Modified Project site or in the vicinity of the proposed Project. Consistent with the previous analysis for the Approved Project, the Modified Project would not involve changes to the environment that would result in conversion of farmland to non-agricultural use or forestland to non-forest use. No new impact would occur.

Conclusion

The impacts of the Modified Project would be consistent with the impacts identified for the previously Approved Project analyzed in the IS/MND. The Modified Project would not create a new significant impact or a substantial increase in the severity of previously identified effects. In regard to Section 15162 of the State CEQA Guidelines, the Modified Project (1) would not propose substantial changes; (2) would not have circumstantial changes when the Project is undertaken; (3) would bring about no new information of substantial importance that would (a) create new significant impacts, (b) increase the severity of previously examined effects, or (c) determine that mitigation measures or alternatives previously found not to be feasible would, in fact, be feasible; or (4) introduce mitigation measures that are considerably different from those analyzed in the previous documents. For these reasons, no major revisions to the agriculture and forestry resources analysis provided in the IS/MND are required.

Mitigation Program

No mitigation for agricultural and forestry resources impacts was required in the IS/MND.

4.3 AIR QUALITY

4.3.1 SUMMARY OF PREVIOUS ENVIRONMENTAL ANALYSIS

Orange Park Acres Well Replacement Project Initial Study/Mitigated Negative Declaration

The IS/MND for the Approved Project determined that the Project would have no impact regarding conflict with or obstruction of implementation of the South Coast Air Quality Management District's (SCAQMD's) Air Quality Management Plan (AQMP).

The IS/MND determined that construction and operation of the Approved Project would not have generated emissions exceeding SCAQMD project significance thresholds for regional or localized emissions, and for construction and operation of the Project. Further, the Approved Project was determined to have a less than significant impact regarding a cumulatively considerable net increase of any criteria pollutant because the Approved Project was deemed to be consistent with the AQMP, and the mass regional emissions calculated for the Project were lower than the SCAQMD's daily significance thresholds. The IS/MND determined that sensitive receptors would not be exposed to any substantial localized or regional air pollution impacts, and therefore, it determined that impacts to substantial pollutant concentration exposure to sensitive receptors would be less than significant.

Additionally, the IS/MND concluded that the implementation of SCAQMD rules such as Rule 1108, limiting volatile organic compound (VOC) content from cutback asphalt, Rule 403, for fugitive dust, and Rule 402, for nuisance odors would ensure that the Approved Project would not result in significant impacts regarding creation of objectional odors affecting a substantial number of people.

4.3.2 PROJECT ENVIRONMENTAL REVIEW

Where available, the significance criteria established by the applicable air quality management district or air pollution control district may be relied upon to make the following determinations.

Would the project:

a) *Conflict with or obstruct implementation of the applicable air quality plan?*

No Substantial Change from Previous Analysis. The SCAQMD develops rules and regulations, establishes permitting requirements for stationary sources, inspects emissions sources, and enforces such measures through educational programs or fines, when necessary. It is directly responsible for reducing emissions from stationary (area and point) and indirect sources and has prepared an AQMP that establishes a program of rules and regulations directed at attaining the National Ambient Air Quality Standards (NAAQS) and California Ambient Air Quality Standards CAAQS.

The SCAQMD adopted the 2016 AQMP on March 3, 2017 (SCAQMD 2017). The 2016 AQMP incorporates the latest scientific and technical information and planning assumptions, including the 2016–2040 Regional Transportation Plan/Sustainable Communities Strategy (RTP/SCS), updated emission inventory methodologies for various source categories, and Southern California Association of Government's (SCAG) latest growth forecasts.¹ The main purpose of an AQMP is to bring an area into compliance with the requirements of federal and State air quality standards.

¹ The more recent SCAG 2020–2045 RTP/SCS will be used for the 2021 AQMP.

For a project to be consistent with the AQMP, the pollutants emitted from the Project should not (1) exceed the SCAQMD CEQA air quality significance thresholds or (2) conflict with or exceed the assumptions in the AQMP.

In order to be consistent with the AQMP, the Modified Project's construction and operational emissions are compared with the SCAQMD CEQA air quality significance thresholds, as detailed later in this analysis. A Project may have a significant impact where project-related emissions would exceed federal, State, or regional standards or thresholds, or where project-related emissions would substantially contribute to an existing or projected air quality violation. The SCAQMD has developed construction and operations thresholds to determine whether projects would potentially result in contributing toward a violation of ambient air quality standards. The SCAQMD recommends that projects be evaluated in terms of the quantitative thresholds established to assess both the regional and localized impacts of project-related air pollutant emissions. IRWD uses the current SCAQMD thresholds, detailed in Table 4-1, South Coast Air Quality Management District Air Quality Significance Thresholds, to determine whether a Modified Project would have a significant impact.

**TABLE 4-1
SOUTH COAST AIR QUALITY MANAGEMENT DISTRICT
AIR QUALITY SIGNIFICANCE THRESHOLDS**

Mass Daily Thresholds (lbs/day)		
Pollutant	Construction	Operation
VOC	75	55
NOx	100	55
CO	550	550
PM10	150	150
PM2.5	55	55
SOx	150	150
Lead	3	3

lbs/day: pounds per day; VOC: volatile organic compound; NOx: nitrogen oxides; CO: carbon monoxide; PM10: respirable particulate matter 10 microns or less in diameter; PM2.5: fine particulate matter 2.5 microns or less in diameter; SOx: sulfur oxides.
Source: SCAQMD 2019.

As shown in Response to Threshold 4.3.2 (b) below, pollutant emissions from the Modified Project would be less than the SCAQMD thresholds and would not result in a significant impact. The Project is consistent with the Zoning and General Plan Land Use designations for the site and is therefore consistent with the growth expectations for the region. Further, the Modified Project would not directly result in population growth or development or new land uses that have not been anticipated in the AQMP. Consistent with the Approved Project, no conflict with the applicable AQMP would occur with the Modified Project, as consistent with the IS/MND, and there would be no impact. There would be no substantial change from previous analysis.

b) Result in a cumulatively considerable net increase of any criteria pollutant for which the project region is non-attainment under an applicable federal or state ambient air quality standard?

No Substantial Change from Previous Analysis. Air pollutant emissions for the Modified Project were estimated using the California Emissions Estimator Model (CalEEMod) version 2020.4.0 computer program (CAPCOA 2021). CalEEMod is designed to model construction and operational emissions for land development projects and allows for the input of project- and

county-specific information. For air quality modeling purposes, construction of the Project was based on the Modified Project’s construction assumptions and default assumptions derived from CalEEMod.

Construction Emissions

The regional emissions thresholds (see Table 4-1) are based on the rate of emissions (i.e., pounds of pollutants emitted per day). Therefore, the quantity, duration, and the intensity of construction activities are important in ensuring analysis of worst-case (i.e., maximum daily emissions) scenarios. Each construction activity has associated off-road equipment (e.g., backhoes, cranes) and on-road vehicles (e.g., haul trucks, concrete trucks, worker commute vehicles). Detailed construction assumptions and CalEEMod inputs and outputs can be found in Appendix A, Air Quality and Greenhouse Gas Emissions Modeling Data.

Maximum daily construction emissions during the peak workday are shown in Table 4-2, Estimated Maximum Daily Construction Emissions. If construction is delayed or occurs over a longer time period, emissions could be reduced because of (1) a more modern and cleaner-burning construction equipment fleet mix and/or (2) a less intensive buildout schedule (i.e., fewer daily emissions occurring over a longer time interval). Construction of the Modified Project would be required to comply with SCAQMD Rule 403, as discussed above. Additionally, in accordance with Section 2449(d)(3) of the California Air Resources Board’s (CARB’s) Regulation for In-Use Off-Road Diesel-Fueled Fleets, construction equipment and vehicles are required to limit idling times to no more than five consecutive minutes. As shown and consistent with the findings of the IS/MND, all criteria pollutant emissions from Modified Project construction would be less than their respective thresholds. As such, there would be no substantial change from the previous analysis.

**TABLE 4-2
ESTIMATED MAXIMUM DAILY CONSTRUCTION EMISSIONS
(LBS/DAY)**

Construction Year	VOC	NOx	CO	SOx	PM10	PM2.5
2022	1	13	14	<1	1	1
Maximum	1	13	14	<1	1	1
SCAQMD Daily Thresholds	75	100	550	150	150	55
Exceeds SCAQMD Thresholds?	No	No	No	No	No	No
lbs/day: pounds per day; VOC: volatile organic compound(s); NOx: nitrogen oxides; CO: carbon monoxide; SOx: sulfur oxides; PM10: respirable particulate matter with a diameter of 10 microns or less; PM2.5: fine particulate matter with a diameter of 2.5 microns or less; SCAQMD: South Coast Air Quality Management District. Source: SCAQMD 2019 (thresholds). Emissions calculated by Psomas using CalEEMod 2020.4.0 (Appendix A, Air Quality and Greenhouse Gas Emissions Modeling Data)						

Localized Construction Impacts

The localized effects from the on-site portion of daily emissions were evaluated at sensitive receptor locations that would be potentially impacted by the Project; these were evaluated according to the SCAQMD’s localized significance threshold (LST) methodology, which utilizes on-site mass emissions rate look up tables and Project-specific modeling, where appropriate. LSTs are applicable to the following criteria pollutants: nitrogen dioxide (NO₂), carbon monoxide (CO), respirable particulate matter with a diameter of 10 microns or less (PM10), and fine particulate matter with a diameter of 2.5 microns or less (PM2.5).² LSTs represent the maximum

² NO₂ impacts are addressed by evaluating nitrogen oxide (NOx) emissions.

emissions from a project that are not expected to cause or contribute substantially to an exceedance of the most stringent applicable federal or State ambient air quality standard. These are developed based on the ambient concentrations of that pollutant for each source receptor area and distance to the nearest sensitive receptor. For PM10 and PM2.5, LSTs were derived based on requirements in SCAQMD’s Rule 403 regarding fugitive dust. For the LST CO and NO₂ exposure analysis, receptors who could be exposed for one hour or more are considered. For PM10 and PM2.5 exposure analysis, receptors who could be exposed for 24 hours are considered. The mass rate look-up tables were developed for each source receptor area and can be used to determine whether or not a project may generate significant adverse localized air quality impacts. The SCAQMD provides LST mass rate look-up tables (i.e., screening thresholds) for projects that are less than or equal to five acres. The use of a LST screening threshold based on 1-acre was used to assess the potential for localized construction air quality impacts associated with the Project.

When quantifying mass emissions for localized analysis, only emissions that occur on site are considered. Consistent with the SCAQMD’s LST methodology guidelines, emissions related to off-site delivery/haul truck activity and employee trips are not considered in the evaluation of localized impacts.

As shown in Table 4-3, Maximum Localized Construction Pollutant Emissions, localized construction emissions were evaluated for the maximum localized onsite emissions for nitrogen oxides (NOx), CO, PM10, and PM2.5. This maximum scenario occurred during grading and trenching activities in 2022. Emissions occurring at the Modified Project site would be less than their respective SCAQMD LST screening thresholds. Thus, consistent with the findings of the IS/MND, construction impacts related to air pollutant exposure to sensitive receptors proximate to the Modified Project site would be less than significant, and no mitigation is required.

**TABLE 4-3
MAXIMUM LOCALIZED CONSTRUCTION POLLUTANT EMISSIONS
(LBS/DAY)**

	NOx	CO	PM10	PM2.5
Maximum Emissions	13	14	1	1
SCAQMD LST Screening Threshold^a	81	485	4	3
Exceeds SCAQMD Screening Thresholds?	No	No	No	No
lbs/day: pounds per day; NOx: nitrogen oxides; CO: carbon monoxide; PM10: respirable particulate matter with a diameter of 10 microns or less; PM2.5: fine particulate matter with a diameter of 2.5 microns or less; SCAQMD: South Coast Air Quality Management District; LST: Local Significance Threshold; SRA: Source Receptor Area. ^a Thresholds are for 1-acre site with receptors located within 25 meters in Source Receptor Area (SRA) 17, Central Orange County. Source: SCAQMD 2009 (LSTs). Emissions from Psomas calculated with CalEEMod 2020.4.0 (Appendix A).				

Operational Emissions

Consistent with the Approved Project, operations associated with the Modified Project would generally include facility inspection and maintenance activities on a daily basis, which is consistent with existing conditions. No new employees would be required for operation of the Modified Project. As such, consistent with the Approved Project, because the Modified Project would require very little maintenance once construction is completed and only on an as-needed basis, the Modified Project would have less than significant impacts and would not result in more substantial impacts than previously analyzed in the IS/MND.

Cumulative Impacts

The SCAQMD, in their White Paper on Regulatory Options for Addressing Cumulative Impacts from Air Pollution Emissions (presented to the Board on September 5, 2003), identifies that impacts that are less than significant on a Project level are also considered to be less than significant on a cumulative basis. The AQMD uses the same significance thresholds for project-specific and cumulative impacts analyzed in an Environmental Assessment (EA) or an EIR, except for the Hazard Index for toxic air contaminant emissions (SCAQMD 2003). Any projects that are found to result in less than significant impacts on a project level are not considered to be cumulatively considerable and consequently would not result in a considerable contribution to cumulative impacts. Using this rationale, since the Modified Project impacts were identified as less than significant, the cumulative impacts were also identified as less than significant, and no mitigation is required. This is consistent with the approach and impact finding of the IS/MND. As such, there would be no substantial change from the IS/MND. No new impact would occur.

c) Expose sensitive receptors to substantial pollutant concentrations?

No Substantial Change from Previous Analysis. Exposure of sensitive receptors is addressed for the following situations: CO hotspots; criteria pollutants from on-site construction; and TACs from on-site construction.

Carbon Monoxide Hotspot

A CO hotspot is an area of elevated CO concentrations that is caused by severe vehicle congestion on major roadways, typically near intersections. If a project substantially increases average delay at signalized intersections that are operating at Level of Service (LOS) E or F or causes an intersection that would operate at LOS D or better without the Project to operate at LOS E or F with the Project, there is a potential for a CO hotspot.

As stated above, consistent with the Approved Project, operations associated with the Modified Project would generally include facility inspection and maintenance activities on a daily basis, which is consistent with existing conditions. No new employees would be required for operation of the Modified Project. This volume of Project-related vehicle trips would not have the potential to substantially change the average LOS at nearby intersections and consequently would not contribute to the potential for the formation of a CO hotspot.

Criteria Pollutants from On-Site Construction

Exposure of persons to NO₂, CO, PM₁₀, and PM_{2.5} emissions is discussed in the LST analysis, under Threshold 4.3 (b). As discussed, there would be a less than significant impact.

Toxic Air Contaminants Impacts

The greatest potential for toxic air contaminant (TAC) emissions during construction would be related to diesel particulate emissions associated with heavy equipment operations during site grading activities. The SCAQMD does not consider diesel-related cancer risks from construction equipment to be an issue due to the short-term nature of construction activities. Construction activities associated with the Modified Project would be short term (7 months), and less than the anticipated schedule for the Approved Project. The assessment of cancer risk is typically based on a 30- to 70-year exposure period. Because exposure to diesel exhaust would be well below the 30- and 70-year exposure period, construction of the Modified Project is not anticipated to result in an elevated cancer risk to exposed persons. As such, Project-related TAC impacts during

construction would be less than significant, and no mitigation is required. The Modified Project would not result in a substantial change from the IS/MND. No new impact would occur.

d) Result in other emissions (such as those leading to odors) adversely affecting a substantial number of people?

No Substantial Change from Previous Analysis. During construction, the Modified Project would require the use of equipment that may generate odors. Potential construction odors would result from on-site construction equipment's diesel exhaust emissions or paving operations. However, these odors would be temporary and would dissipate rapidly from the source with an increase in distance. The generation of these emissions would not rise to the order of a public nuisance. Construction odors would be considered less than significant. Furthermore, according to the SCAQMD's *CEQA Air Quality Handbook*, land uses associated with odor complaints typically include agricultural uses, wastewater treatment plants, food processing plants, chemical plants, composting, refineries, landfills, dairies, and fiberglass molding (SCAQMD 1993).

The Modified Project would not include any uses identified by the SCAQMD as being associated with odors and, therefore, would not produce objectionable odors.. No new chemicals would be added as part of the water treatment process for the Project. Therefore, consistent with the Approved Project, the water treatment system is not anticipated to produce odor complaints, as existing, previous IRWD projects had not experienced odor complaints with similar facilities. However, similar precautionary measures, such as containment areas and spill plans per State, regional, and local requirements, would continue to be employed to guarantee that operations continue to be free of odor violations. The Project uses are also regulated from nuisance odors or other objectionable emissions by SCAQMD Rule 402. Rule 402 prohibits any the discharge from any source of air contaminants or other material which would cause injury, detriment, nuisance, or annoyance to people or the public. As such, the Modified Project would have a less than significant impact with regard to other emissions which may adversely affect a substantial number of people. No mitigation is required. No new impact would occur.

Conclusion

The impacts of the Modified Project would be consistent with the impacts identified for the previously Approved Project analyzed in the IS/MND. The Modified Project would not create a new significant impact or a substantial increase in the severity of previously identified effects. In regard to Section 15162 of the State CEQA Guidelines, the Modified Project (1) would not propose substantial changes; (2) would not have circumstantial changes when the Project is undertaken; (3) would bring about no new information of substantial importance that would (a) create new significant impacts, (b) increase the severity of previously examined effects, or (c) determine that mitigation measures or alternatives previously found not to be feasible would, in fact, be feasible; or (4) introduce mitigation measures that are considerably different from those analyzed in the previous documents. For these reasons, no major revisions to the air quality analysis provided in the IS/MND are required.

Mitigation Program

No mitigation for air quality impacts was required in the IS/MND.

4.4 BIOLOGICAL RESOURCES

4.4.1 SUMMARY OF PREVIOUS ENVIRONMENTAL REVIEW

Orange Park Acres Well Replacement Project Initial Study/Mitigated Negative Declaration

The IS/MND identified that the Approved Project site is located within a developed, urban area and is devoid of vegetation except for ornamental landscaping. The Approved Project site is located in the Santa Ana River Watershed where the Santa Ana River is the major drainage course and is approximately 300 feet to the south of the Santiago Creek Recharge Basin. According to the City of Orange General Plan PEIR, the Approved Project site is not located within the City of Orange's adopted Natural Community Conservation Plan and Habitat Conservation (NCCP/HCP) Habitat Reserve area.

The IS/MND concluded, based on a review of the site's existing conditions and the General Plan PEIR, that the site did not contain habitat which would support candidate, sensitive, or special status (i.e., threatened or endangered) species. Further, the IS/MND determined that the site does not support any riparian habitat, wetlands, or other sensitive natural community. There are no fish or wildlife nursery sites existing on the Approved Project site. Additionally, the IS/MND concluded the Approved Project would not result in direct or indirect impacts to the Santa Ana River, Santiago Creek Recharge Basin, or the Orange County NCCP/HCP.

Implementation of the Approved Project would not conflict with any local policies or ordinances protecting biological resources; would not interfere with the movement of any native resident or migratory fish or wildlife species or with established native resident or migratory wildlife corridors, or impede the use of native wildlife nursery sites; would not conflict with the provisions of an adopted habitat conservation plan, natural community conservation plan, or other approved local, regional, or State habitat conservation plan. There would be no impact.

Construction of the Approved Project would likely occur during the nesting season for birds and therefore there was a moderate probability of construction affecting nesting birds in the ornamental landscaping. **MM BIO-1** would be implemented to comply with the Migratory Bird Treaty Act and to reduce impacts to nesting birds to less than significant. Therefore, the IS/MND concluded that the Approved Project would not result in a significant impacts related to biological resources. With implementation of **MM BIO-1**, impacts would be less than significant with **MM BIO-1**.

4.4.2 PROJECT ENVIRONMENTAL REVIEW

Would the Project:

- a) *Have a substantial adverse effect, either directly or through habitat modifications, on any species identified as a candidate, sensitive, or special status species in local or regional plans, policies, or regulations, or by the California Department of Fish and Wildlife or U.S. Fish and Wildlife Service?*

No Substantial Change from Previous Analysis. Consistent with the previous analysis for the Approved Project, the site is located within a developed, urban area with an existing well and associated infrastructure. The site is devoid of vegetation except for ornamental landscaping. No native habitat or other habitat suitable for sensitive species is present on site. If construction occurs during avian nesting season, **MM BIO-1** would be required to comply with the MBTA and to reduce impacts to nesting birds to less than significant. Therefore, consistent with the Approved Project, development of the Modified Project would not have a substantial effect on a candidate,

sensitive, or special status species and implementation of **MM BIO-1** would ensure impacts to nesting birds would be less than significant. No new impact would occur.

b) Have a substantial adverse effect on any riparian habitat or other sensitive natural community identified in local or regional plans, policies, regulations or by the California Department of Fish and Wildlife or U.S. Fish and Wildlife Service?

No Substantial Change from Previous Analysis. Based on a site visit on June 19, 2021, the Modified Project site contains an existing well, associated infrastructure, surface parking at 678 North Gravier Street and an existing IRWD-owned single-story residence at 660 North Gravier Street. No riparian habitat (that is, habitat occurring along the banks of rivers and streams) or sensitive natural community are present on site. The nearest riparian habitat to the Modified Project site mapped on the National Wetlands Mapper maintained by the U.S. Fish and Wildlife Service is the Santiago Creek Recharge Basin about 300 feet north of the site (USFWS 2021). Consistent with the previous analysis for the Approved Project, the Modified Project would not result in an adverse effect on riparian habitat or other sensitive natural community. No new impact would occur.

c) Have a substantial adverse effect on state or federally protected wetlands (including, but not limited to, marsh, vernal pool, coastal, etc.) through direct removal, filling, hydrological interruption, or other means?

No Substantial Change from Previous Analysis. The Modified Project site contains an existing well, associated infrastructure, residential and utility structures, and surface parking. The site is devoid of vegetation except for ornamental landscaping and devoid of any water resources. Consistent with the previous analysis for the Approved Project, no State- or federally protected wetlands are present on site, and no new impact to wetlands would occur.

d) Interfere substantially with the movement of any native resident or migratory fish or wildlife species or with established native resident or migratory wildlife corridors, or impede the use of native wildlife nursery sites?

No Substantial Change from Previous Analysis. The Modified Project site is fully developed with residential and utility uses. As identified in the IS/MND the Approved Project site is located over 1 mile west of the nearest Orange County NCCP/HCP designated reserve and special linkage areas. Consistent with the previous analysis for the Approved Project, due to the lack of habitat on-site, the Modified Project would not interfere with the movement of any native resident or migratory fish or wildlife species or with established native resident or migratory wildlife corridors, or impede the use of native wildlife nursery sites. No new impact would occur.

e) Conflict with any local policies or ordinances protecting biological resources, such as a tree preservation policy or ordinance?

No Substantial Change from Previous Analysis. City of Orange Municipal Code Section 12.32.020 makes it unlawful to destroy or remove any tree as defined in Section 12.32.020 from an undeveloped or public interest property as defined in Section 12.32.040 and 12.32.050, respectively. Public Interest Property, as defined in 12.32.50, shall be any property, privately owned or otherwise, whether developed or undeveloped, which has, because of the presence of certain trees of historical value in such property, become property endowed with a public interest. IRWD would comply with applicable City of Orange Tree Preservation ordinances, as-required. Consistent with the Approved Project, the Modified Project would not conflict with any local

policies or ordinances protecting biological resources. Impacts would be less than significant; no new impact would occur.

f) Conflict with the provisions of an adopted Habitat Conservation Plan, Natural Community Conservation Plan, or other approved local, regional, or state habitat conservation plan?

No Substantial Change from Previous Analysis. Consistent with the previous analysis for the Approved Project, the Modified Project site is outside the Plan area of the Orange County Central-Coastal NCCP. Therefore, the Modified Project development would not conflict with the NCCP, and no new impact would occur.

Conclusion

The impacts of the Modified Project would be consistent with the impacts identified for the previously Approved Project analyzed in the IS/MND. The Modified Project would not create a new significant impact or a substantial increase in the severity of previously identified effects. In regard to Section 15162 of the State CEQA Guidelines, the Modified Project (1) would not propose substantial changes; (2) would not have circumstantial changes when the Project is undertaken; (3) would bring about no new information of substantial importance that would (a) create new significant impacts, (b) increase the severity of previously examined effects, or (c) determine that mitigation measures or alternatives previously found not to be feasible would, in fact, be feasible; or (4) introduce mitigation measures that are considerably different from those analyzed in the previous documents. For these reasons, no major revisions to the biological resources analysis provided in the IS/MND are required.

Mitigation Program

The following mitigation measure was identified in the Previously Approved IS/MND and is applicable to the Modified Project.

- BIO-1** If the removal of ornamental trees on site is scheduled during the avian nesting season (approximately February 1 through August 31), a preconstruction survey for nesting birds shall be conducted by a qualified biologist no more than 7 days prior to the start of construction. If nesting birds are detected within the disturbance limits, a buffer around the nest shall be determined by a qualified biologist. If the biologist determines that the construction activity within the buffer has the potential to disturb an active nest, construction activities may be limited or halted until the biologist has determined that the nesting activity is complete.

4.5 CULTURAL RESOURCES

4.5.1 SUMMARY OF PREVIOUS ENVIRONMENTAL REVIEW

Orange Park Acres Well Replacement Project Initial Study/Mitigated Negative Declaration

According to the IS/MND, the Approved Project site does not contain any known historically significant resources. A record search conducted on February 22, 2010 at South Central Coast Information Center (SCCIC) in Fullerton confirmed there are no known listed properties within 0.25-mile radius of the Approved Project site eligible for either the NRHP, the CRHR, California Historical Landmarks, and California Points of Historical Interest. The nearest historic resource listed on the National Register is Old Town Historic District in the City of Orange, approximately two miles away from the Approved Project site. No other historic resources were identified; therefore, construction and operation of the Approved Project would not result in substantial adverse change to a historic resource of the Approved Project.

The IS/MND determined that the Approved Project site is not located in an area identified as having a high sensitivity for archaeological resources and a literature review and record search confirmed none of the existing prehistoric archaeological sites documented in the City of Orange General Plan PEIR are located in or adjacent to the Approved Project site. Therefore, the potential for discovery of archaeological resources or disturbances of human resources is low. However, grading and excavation activities related to the development of the Approved Project have the potential to result in the disturbance of undiscovered archaeological resources, thereby resulting in a potentially significant impact. Should any potential undocumented buried archaeological resources be uncovered during construction, IRWD's standard operating procedures for contractors involve ceasing construction immediately within 50 feet of the discovery, contacting a qualified archaeologist to assess the significance of the find and, if necessary, developing appropriate treatment measures before proceeding with construction. Potential effects to unknown resources would be less than significant levels.

The IS/MND concluded that no known formal cemeteries are present on the Approved Project site; but identified some potential for encountering undiscovered human remains during development activities. The IS/MND concluded that compliance with Section 7050.5 of the *California Health and Safety Code* and Section 5097.98 of the *California Public Resources Code*, which require the County Coroner to be notified immediately if any human remains are encountered, would ensure that less than significant levels.

4.5.2 PROJECT ENVIRONMENTAL REVIEW

Would the Project:

- a) Cause a substantial adverse change in the significance of a historical resource pursuant to in § 15064.5?**

No Substantial Change from Previous Analysis. Consistent with the previous analysis for the Approved Project, No historic resources either on or adjacent to the Approved Project site were identified in the City of Orange General Plan PEIR (Orange 2010. Additionally, the IS/MND identified the nearest cultural resource eligible for either listing on the National Register of Historic Places (NRHP) and/or the California Register of Historic Resources (CRHR) as the Old Town Historic District in the City of Orange, located approximately two miles southwest of the Approved Project site. Furthermore, there are no known listed properties eligible for either the NRHP, the CRHR, California Historical Landmarks, and California Points of Historical Interest within 0.25-mile radius of the Modified Project site (NPS 2021, OHP 2021a, OHP 2021b). Therefore, the

Modified Project development would not diminish the historical significance of an eligible resource. Consistent with the previous IS/MND for the Approved Project, the Project site is IRWD-owned land and located in an urban community established; therefore, Modified Project development would not degrade the significance of a historical resource, and no new impact would occur.

b) Cause a substantial adverse change in the significance of an archaeological resource pursuant to § 15064.5?

No Substantial Change from Previous Analysis. Consistent with the previous analysis for the Approved Project, the Modified Project would occur within the boundaries of existing IRWD-owned land and grading and excavation would not exceed the depths that were previously evaluated for the Approved Project. Construction activities would occur within an area that has been subject to previous development associated with residential and utility uses. Potential impacts of the Modified Project to buried archaeological resources would be similar to impacts of the Approved Project. Consistent with the Approved Project, should any potential undocumented buried archaeological resources be uncovered during construction, IRWD's standard operating procedures for contractors involve ceasing construction immediately within 50 feet of the discovery, contacting a qualified archaeologist to assess the significance of the find and, if necessary, develop appropriate treatment measures before proceeding with construction. Consistent with the Approved Project, impacts of the Modified Project would be less than significant, and no new impact would occur.

c) Disturb any human remains, including those interred outside of dedicated cemeteries?

No Substantial Change from Previous As explained in response to threshold 4.5.2 (b), the Modified Project would involve a similar level of disturbance of previously undisturbed soil as with the Approved Project. Thus, the potential for disturbance of human remains by Modified Project development would be the same as compared to the Approved Project. If, in the highly unlikely event human remains are uncovered during construction, IRWD's standard operating procedures involve implementing actions as specified by State Health and Safety Code Section 7050.5. This section states that no further disturbance would occur until the County Coroner has made the necessary findings as to origin and disposition pursuant to Public Resources Code 5097.98. If such a discovery occurs, excavation or construction would halt in the area of the discovery, the area would be protected, and consultation and treatment will occur as prescribed by law. If the Coroner recognizes the remains to be Native American, he or she would contact the Native American Heritage Commission, who would appoint the Most Likely Descendent. Additionally, if the bones are determined to be Native American, a plan would be developed regarding the treatment of human remains and associated burial objects, and the plan would be implemented under the direction of the Most Likely Descendent. The Modified Project would comply with the same State laws governing accidental discoveries of human remains identified for the Approved Project, and no new impact would occur.

Conclusion

The impacts of the Modified Project would be consistent with the impacts identified for the previously Approved Projects analyzed in the IS/MND. The Modified Project would not create a new significant impact or a substantial increase in the severity of previously identified effects. In regard to Section 15162 of the State CEQA Guidelines, the Modified Project (1) would not propose substantial changes; (2) would not have circumstantial changes when the Project is undertaken; (3) would bring about no new information of substantial importance that would (a) create new significant impacts, (b) increase the severity of previously examined effects, or (c) determine that mitigation measures or alternatives previously found not to be feasible would, in fact, be feasible;

or (4) introduce mitigation measures that are considerably different from those analyzed in the previous documents. For these reasons, no major revisions to the cultural resources analysis provided in the IS/MND are required.

Mitigation Program

No mitigation for cultural resources impacts was required in the IS/MND.

4.6 ENERGY

4.6.1 SUMMARY OF PREVIOUS ENVIRONMENTAL REVIEW

Orange Park Acres Well Replacement Project Initial Study/Mitigated Negative Declaration

Energy impacts were not separately analyzed in the IS/MND because Energy, as a separate issue was added to the CEQA Checklist Appendix G in the 2019 State CEQA Guidelines. The section below provides an analysis of Energy for the Modified Project. Energy impacts of the Approved Project were addressed in the Greenhouse Gas Emissions (GHG) response of the IS/MND.

The IS/MND analyzed energy of the Approved Project in relation to the reduction of Proposed Project operational GHG emissions that would result from onsite electricity consumption. In their AB 32 Scoping Plan, CARB has set in place aggressive energy efficiency measures requiring that 33% of all energy consumed in California come from renewable sources by 2020. Assuming conformity with CARB standards, GHG emissions in 2020 associated with operation of the Approved Project were expected to be 33% less than under Business As Usual (BAU) conditions.

The Approved Project was anticipated to require approximately 5,148,000 kilowatt hours (kWh) of electrical consumption per year. The Approved Project was not anticipated to require natural gas during construction and operations.

4.6.2 PROJECT ENVIRONMENTAL REVIEW

Would the project:

- a) ***Result in potentially significant environmental impact due to wasteful, inefficient, or unnecessary consumption of energy resources, during project construction or operation?***

No Substantial Change from Previous Analysis. Modified Project construction would require the use of construction equipment for demolition, grading, building modifications, and paving activities. The Modified Project would not require drilling of a replacement well, and as such, would not require 24-hour well drilling activities. Construction would also continue to include vehicles of construction workers and vendors traveling to and from the Modified Project site, consistent with the Approved Project. Fuel energy consumed during construction would be temporary in nature. Furthermore, there are no unusual Modified Project characteristics that would necessitate the use of less energy-efficient construction equipment compared to the Approved Project.

Consistent with the findings in the IS/MND, the Modified Project would not substantially change operations of the Approved Project uses and would therefore not create a new significant impact due to wasteful, inefficient, or unnecessary consumption of energy resources during operations. The Modified Project would result in additional electrical consumption to treat groundwater. However, the Modified Project is a utility project designed to treat groundwater supplies and serve IRWD customers and would not be considered to be wasteful, inefficient, or unnecessary consumption of energy resources. Additionally, energy used in the operation of the Project would enable the use of local water resources that would reduce the need to use more energy intensive imported water. Consistent with the Approved Project, natural gas would not be required for Modified Project implementation. The Modified Project would require daily monitoring trips and monthly maintenance trips, which is consistent with existing conditions and with the assumptions of the Approved Project. No new employees would be required for operation of the Project. Therefore, the Modified Project would not create a new significant impact pertaining to energy

consumption that could be wasteful, inefficient, or unnecessary consumption of energy resources, and no new mitigation measures are required.

b) Conflict with or obstruct a state or local plan for renewable energy or energy efficiency?

No Substantial Change from Previous Analysis. As discussed above, the Modified Project would use energy during the construction phase, consistent with the Approved Project. Operation of the Modified Project would result in additional electrical consumption—however, as stated above, the Project is a utility project designed to treat groundwater supplies and serve IRWD customers. This would reduce reliance on imported water by treating existing, local water for potable use. Therefore, the Modified Project would not create a significant impact pertaining to a conflict with or obstruction of a state or local plan for renewable energy or energy efficiency, and no new mitigation measures are required.

Conclusion

The impacts of the Modified Project would be consistent with the impacts identified for the previously Approved Project analyzed in the IS/MND. The Modified Project would not create a new significant impact or a substantial increase in the severity of previously identified effects. In regard to Section 15162 of the State CEQA Guidelines, the Modified Project (1) would not propose substantial changes; (2) would not have circumstantial changes when the project is undertaken; (3) would bring about no new information of substantial importance that would (a) create new significant impacts, (b) increase the severity of previously examined effects, or (c) determine that mitigation measures or alternatives previously found not to be feasible would, in fact, be feasible; or (4) introduce mitigation measures that are considerably different from those analyzed in the previous documents. For these reasons, no major revisions to the energy use provided in the IS/MND are required.

Mitigation Program

Potential impacts related to energy use was not evaluated previously in the IS/MND. Less than significant energy related impacts were found for the Modified Project. As such, no mitigation measures are required or recommended.

4.7 GEOLOGY AND SOILS

4.7.1 SUMMARY OF PREVIOUS ENVIRONMENTAL REVIEW

Orange Park Acres Well Replacement Project Initial Study/Mitigated Negative Declaration

According to the IS/MND, the Approved Project site is not located within an Earthquake Fault Zone (EFZ) as reported by the California Geological Survey. The IS/MND noted the Approved Project is located approximately 30 miles from large, active faults and in the vicinity of smaller faults. Further, as is with all Southern California communities, the site would be subject to seismic ground shaking; therefore, the Approved Project would be constructed in accordance with the California Building Code (CBC) and all applicable City of Orange codes and regulations to minimize seismic ground shaking impacts. The Approved Project would not create any new habitable structures and therefore would not expose people or structures to potentially substantial adverse effects involving a known earthquake fault and seismic ground shaking. Impacts would be less than significant.

The IS/MND determined the Approved Project site is located in a liquefaction hazards area; however, a geotechnical report determined the area to have a low potential for liquefaction. Compliance with **MM GEO-1**, requiring a preconstruction geotechnical assessment, would reduce potential risks due to lateral spreading, liquefaction, subsidence, unstable soils, or expansive soils to less than significant levels. Additionally, as stated previously the Approved Project would be in compliance with the CBC all applicable City of Orange codes and regulations. Therefore, impacts associated with liquefaction would be less than significant with mitigation incorporated.

The IS/MND determined the Approved Project site is located on a flat topography and is not identify as a Landslide Hazards Area. Therefore, no impact would occur involving landslides. The Approved Project would not substantially alter the existing drainage pattern of the site and would not substantially change the impervious area on the Approved Project site. The Approved Project would comply with regulatory requirements minimizing soil erosion during project construction and operation. Impacts involving soil erosion would be less than significant.

4.7.2 PROJECT ENVIRONMENTAL REVIEW

A Geotechnical Investigation Report was prepared by Converse Consultants on April 2, 2021. The report, *OCWD PFAS Treatment Facility Orange Park Acres Well No. 1 Wellhead Facilities* was used for the analysis in this section and included in Appendix B of this IS/MND.

Would the Project:

- a) ***Directly or indirectly expose people or structures to potential substantial adverse effects, including the risk of loss, injury, or death involving:***
 - i) ***Rupture of a known earthquake fault, as delineated on the most recent Alquist-Priolo Earthquake Fault Zoning Map issued by the State Geologist for the area or based on other substantial evidence of a known fault? Refer to Division of Mines and Geology Special Publication 42.***

No Substantial Change from Previous Analysis. Consistent with the previous analysis for the Approved Project, the Modified Project site is not located within a current State of California Earthquake Fault Zone, no known active or potentially active faults traverses the site, and the site is not included in an Alquist-Priolo Earthquake Fault Zone (EFZ). (Converse 2021). As with all Southern California, the Modified Project site lies in a seismically active region, and a major

earthquake occurring along any of these faults would be capable of generating seismic hazards and strong ground shaking effects within the City of Orange. However, the Modified Project would not create any new habitable structures and would not expose people or structures to potentially substantial adverse effects including risk of loss, injury, or death involving fault rupture of a known earthquake fault. Therefore, the Modified Project would not create a new significant impact pertaining to faults that was not previously analyzed. Impacts would be less than significant, and no new mitigation measures are required.

ii) Strong seismic ground shaking?

No Substantial Change from Previous Analysis. As discussed in Section 4.7.2. (a.i), the Modified Project is not located within an EFZ; however, the Modified Project site is located within a seismically active region and may be subject to ground shaking during the life of the Project. Consistent with the previous analysis for the Approved Project, the Project should be constructed in accordance with all applicable current codes and standards including the 2019 CBC in order to reduce the effects of ground shaking. The geotechnical investigation for the Approved Project calculated seismic design parameters pursuant to the 2019 CBC. Furthermore, construction and operation of the Modified Project would not create any new habitable structures and would not expose people or structures to potentially substantial adverse effects involving strong seismic ground shaking. Therefore, the Project would not create a new significant impact pertaining to seismic ground shaking that was not previously analyzed. Impacts would be less than significant and no new mitigation measures are required.

iii) Seismic-related ground failure, including liquefaction?

No Substantial Change from Previous Analysis. The Modified Project site is located in an area designated as susceptible to potential liquefaction by the State of California. Based on liquefaction analysis, liquefaction of saturated soils at the Modified Project site is unlikely to occur (Converse 2021). Consistent with the previous analysis for the Approved Project, the Modified Project would comply **MM GEO-1**. All future development associated with the Modified Project would comply with applicable City of Orange and State codes; therefore, impacts related to exposure of people or structures to seismic-related hazards would be the same for the Modified Project. The Project would not create a new significant impact pertaining to seismic-related ground failure that was not previously analyzed. Impacts would be less than significant with mitigation. No new mitigation measures are required.

iv) Landslides?

No Substantial Change from Previous Analysis. Seismically induced landslides and other slope failures are common occurrences during or soon after earthquakes. Consistent with the previous analysis for the Approved Project, the Modified Project site location is not located in an area designated as susceptible to landslides by the State of California. Further, due to the relatively flat topography of the Modified Project site, the potential for landslides is considered to be low (Converse 2021). Therefore, the Modified Project would not create a new significant impact pertaining to landslides that was not previously analyzed. No new impact would occur.

b) Result in substantial soil erosion or the loss of topsoil?

No Substantial Change from Previous Analysis. Ground disturbance during grading and construction could lead to erosion and topsoil loss during wind or rain events, resulting in a potentially significant impact. As discussed in Section 4.10, Hydrology and Water Quality, since Project construction would encompass an area less than 1 acre, Project construction would not require the preparation or implementation of a formal stormwater pollution prevention plan

(SWPPP). Consistent with the previous analysis for the Approved Project, an erosion control plan, sediment control, tracking, waste management, and construction site maintenance best management practices (BMPs) would be implemented to reduce the potential for soil and wind erosion during construction activities. Additionally, all discharge water generated during project construction would be disposed of in accordance with National Pollutant Discharge Elimination System (NPDES) and Orange County Flood Control Department (OCFCD) discharge permits. Operation of the Modified Project would not substantially alter the existing drainage pattern of the site and would not substantially change the impervious area on the Modified Project site. As discussed in Section 4.10, Hydrology and Water Quality, operation of the Modified project would comply with City of Orange Municipal Code Chapter 7.01 (Water Quality and Stormwater Discharges), the provisions set forth in the NPDES permit, and the Orange County Drainage Area Management Plan (DAMP) (Orange 2021b). The Modified Project erosion impacts would be less than significant, and no new significant impact would occur.

c) Be located on a geologic unit or soil that is unstable, or that would become unstable as a result of the project, and potentially result in on- or off-site landslide, lateral spreading, subsidence, liquefaction or collapse?

No Substantial Change from Previous Analysis. No new liquefaction or landslide impacts would occur, as substantiated above in Sections 4.7.2. (a.iii.) and 4.7.2. (a.iv). Lateral spreading is the downslope movement of surface sediment due to liquefaction in a subsurface layer. As there is no risk of liquefaction, there would be no risk of lateral spreading. The Modified Project site is in an area of ground subsidence, mapped by the U.S. Geological Survey (USGS 2021) and located in the Orange County Groundwater Basin. OCWD manages the Basin and is partnering with IRWD in addressing the PFAS contamination. The major cause of ground subsidence is the excessive withdrawal of groundwater. Compliance with **MM GEO-1**, will ensure ground subsidence and collapsible soils would be less than significant with mitigation. Consistent with the previous analysis for the Approved Project, the Modified Project would not create a new significant impact pertaining to onsite or offsite landslide, lateral spreading, subsidence, liquefaction, or collapse that was not previously analyzed, and no new mitigation measures are required.

d) Be located on expansive soil, as defined in Table 18-1-B of the Uniform Building Code (1994), creating substantial risks to life or property?

No Substantial Change from Previous Analysis. Expansive soils contain substantial amounts of clay that swells when wetted and shrinks when dried; the swelling or shrinking can shift, crack, or break structures built on such soils. The geotechnical investigation report included in Appendix B assessed expansion potential of site soils and provided recommendations as needed for remedial grading, soil moistening before and after construction, and foundation design. Consistent with the previous analysis for the Approved Project, the Modified Project would comply with **MM GEO-1** and the 2019 CBC. Modified Project development would not cause substantial hazards arising from expansive soils. Impacts would be less than significant with mitigation. No new impact would occur.

e) Have soils incapable of adequately supporting the use of septic tanks or alternative wastewater disposal systems where sewers are not available for the disposal of wastewater?

No Substantial Change from Previous Analysis. The Modified Project would not include any habitable structures, septic tanks, or alternative wastewater disposal systems. Consistent with the previous analysis for the Approved Project, the Modified Project would not result in impacts

related to soils incapable of supporting septic tanks or alternative wastewater disposal systems. No new impact would occur.

f) Directly or indirectly destroy a unique paleontological resource or site or unique geologic feature?

No Substantial Change from Previous Analysis. Impacts related to Paleontological resources or sites or unique geologic features was analyzed in Section 4.7. Cultural Resources of the IS/MND pursuant to the 2012 State CEQA Guidelines. Consistent with the previous analysis for the Approved Project, the Modified Project would have a similar amount of ground disturbance as the Approved Project. Thus, the Modified Project would have a low potential to damage fossils as was the conclusion in the IS/MND of the Approved Project. However, as stated in the IS/MND, if any potential undocumented buried paleontological fossil resources be uncovered during construction activities, IRWD's standard operating procedures for contractors involve ceasing construction immediately within 50 feet of the discovery, contacting a qualified paleontologist to assess the significance of the find, and, if necessary, develop appropriate treatment measures before proceeding with construction. Therefore, consistent with the finding of the IS/MND, Modified Project impacts to fossils would remain less than significant. No new impact would occur.

Conclusion

The impacts of the Modified Project would be consistent with the impacts identified for the previously Approved Project analyzed in the IS/MND. The Modified Project would not create a new significant impact or a substantial increase in the severity of previously identified effects. In regard to Section 15162 of the State CEQA Guidelines, the Modified Project (1) would not propose substantial changes; (2) would not have circumstantial changes when the Project is undertaken; (3) would bring about no new information of substantial importance that would (a) create new significant impacts, (b) increase the severity of previously examined effects, or (c) determine that mitigation measures or alternatives previously found not to be feasible would, in fact, be feasible; or (4) introduce mitigation measures that are considerably different from those analyzed in the previous documents. For these reasons, no major revisions to the geology and soils analysis provided in the IS/MND are required.

Mitigation Program

The following mitigation measure was identified in the Previously Approved IS/MND and is applicable to the Modified Project.

GEO-1 A design-level geotechnical investigation, including collection of site-specific subsurface data, will be completed by IRWD. The geotechnical investigation will be conducted by a certified engineering geologist or registered geotechnical engineer. The geotechnical investigation will identify appropriate engineering considerations for the planned Project area, including density profiles, depth of groundwater based on borings and historical and regional groundwater data, vertical and lateral extent of the saturated sand/silt layers that could undergo liquefaction, and potential presence of expansive soils. The geotechnical investigation will recommend site-specific design criteria to reduce potential risks due to liquefaction, lateral spreading, subsidence, and expansive soils. The Project shall be designed and constructed in accordance with the recommendations of the geotechnical report.

4.8 GREENHOUSE GAS EMISSIONS

4.8.1 SUMMARY OF PREVIOUS ENVIRONMENTAL REVIEW

Orange Park Acres Well Replacement Project Initial Study/Mitigated Negative Declaration

The IS/MND presented the Project's construction and operational GHG emissions. The Approved Project was anticipated to emit approximately 1,700 metric tons of carbon dioxide equivalent per year (MTCO₂e/yr). This is below the 10,000 MTCO₂e/yr SCAQMD threshold for industrial projects. As such, impacts regarding generation of GHG emissions, either directly or indirectly, that may have a significant impact on the environment, were determined to be less than significant.

The IS/MND also determined that the Approved Project would comply with plans, policies, and regulations intended to reduce GHG emissions, including AB 32 and CARB standards for energy efficiency. As such, the IS/MND stated that there would be less than significant impacts to conflicts with applicable plans, policies, or regulations adopted for the purpose of reducing GHG emissions.

4.8.2 PROJECT ENVIRONMENTAL REVIEW

Would the Project:

- a) *Generate greenhouse gas emissions, either directly or indirectly, that may have a significant impact on the environment?***

No Substantial Change from Previous Analysis. Construction GHG emissions are generated by vehicle engine exhaust from construction equipment, on-road hauling trucks, vendor trips, and worker commuting trips. Construction GHG emissions were calculated by using CalEEMod 2020.4.0. The model and construction assumptions are described in Section 4.3, Air Quality, and are included in Appendix A. The results are output in metric tons of MTCO₂e for each year of construction.

GHG emissions generated from construction activities are finite and occur for a relatively short-term period. Unlike the numerous opportunities available to reduce a project's long-term GHG emissions through design features, operational restrictions, use of green-building materials, or other methods, GHG-reduction measures for construction equipment are relatively limited. Therefore, SCAQMD staff recommends that construction emissions be amortized over a 30-year project lifetime so that GHG-reduction measures will address construction GHG emissions as part of the operational GHG-reduction strategies. As shown in Table 4-4, GHG Emissions from Project Implementation, the 30-year amortized construction emissions of the Project would be 2 MTCO₂e/yr.

**TABLE 4-4
GHG EMISSIONS FROM PROJECT IMPLEMENTATION**

Year	Emissions (MTCO _{2e})
2022	55
Total Construction Emissions	55
Amortized Emissions ¹	2
Operational Emissions	791
Total Annual Emissions²	793
SCAQMD Threshold for Industrial Projects	10,000
Exceeds Threshold?	No
MTCO _{2e} : metric tons of carbon dioxide equivalent; SCAQMD: South Coast Air Quality Management District	
¹ Construction emissions amortized over 30 years.	
² Combined amortized emissions with operational emissions.	
Source: Appendix A, Air Quality and Greenhouse Gas Emissions Modeling Data.	

Operational GHG emissions for the Modified Project are estimated by including electricity, which would amount to 3,367,200 kilowatt hours per year (kWh/yr). The Approved Project anticipated 5,148,000 kWh/yr of electrical consumption, and as such, the Modified Project would require less electricity than the Approved Project anticipated. The Modified Project would require daily monitoring trips and monthly maintenance trips, which is consistent with existing conditions and with the assumptions of the Approved Project. No new employees would be required for operation of the Project. The total estimated annual GHG emissions from operation of the Modified Project would be 793 MTCO_{2e}/yr, primarily from electrical consumption of the Modified Project. This is less than the emissions detailed in the IS/MND, and less than the 10,000 MTCO_{2e}/yr threshold for industrial projects. It is very unlikely that any individual development project would have GHG emissions of a magnitude to directly impact global climate change; therefore, any impact would be considered on a cumulative basis. As such, the Modified Project would not generate GHG emissions, either directly or indirectly, that may have a significant impact on the environment. Impacts would be consistent with the IS/MND, and no new impact would occur related to GHG emissions.

b) Conflict with an applicable plan, policy, or regulation adopted for the purpose of reducing the emissions of greenhouse gases?

No Substantial Change from Previous Analysis. State policies and standards adopted for the purpose of reducing GHG emissions include Executive Order (EO) S-3-05, AB 32, SB 375, and EO B-30-15. The quantitative goal of these regulations is to reduce GHG emissions to 1990 levels by 2020, to 40 percent below 1990 levels by 2030, and to 80 percent below 1990 levels by 2050. Statewide plans and regulations (such as GHG emissions standards for vehicles, the Low Carbon Fuel Standard, Cap-and-Trade, and renewable energy) are being implemented at the statewide level, and compliance at a project level is not addressed. Therefore, consistent with the Approved Project, the Modified Project also does not conflict with these plans and regulations. Consistent with the Approved Project, the majority of GHG emissions for the Modified Project are from electrical consumption. CARB has set stringent energy efficiency measures for the Renewable Portfolio Standard. Additionally, the Modified Project's GHG emissions would be less than those of the Approved Project. The Modified Project would not conflict with applicable plans, policies, or regulations adopted for the purpose of reducing the emissions of GHG. No new impact would occur.

Conclusion

The impacts of the Modified Project would be consistent with the impacts identified for the previously Approved Project analyzed in the IS/MND. The Modified Project would not create a new significant impact or a substantial increase in the severity of previously identified effects. In regard to Section 15162 of the State CEQA Guidelines, the Modified Project (1) would not propose substantial changes; (2) would not have circumstantial changes when the Project is undertaken; (3) would bring about no new information of substantial importance that would (a) create new significant impacts, (b) increase the severity of previously examined effects, or (c) determine that mitigation measures or alternatives previously found not to be feasible would, in fact, be feasible; or (4) introduce mitigation measures that are considerably different from those analyzed in the previous documents. For these reasons, no major revisions to the GHG analysis provided in the IS/MND are required.

Mitigation Program

No mitigation measures for GHG emission impacts was required in the IS/MND.

4.9 HAZARDS AND HAZARDOUS MATERIALS

4.9.1 SUMMARY OF PREVIOUS ENVIRONMENTAL REVIEW

Orange Park Acres Well Replacement Project Initial Study/Mitigated Negative Declaration

The IS/MND identified that construction and operation under the Approved Project would involve transport, use, storage, and disposal of hazardous materials. The IS/MND concluded that the Approved Project would not increase the likelihood of accidental release of hazardous materials. Compliance with existing regulations would ensure hazards from routine use of hazardous materials under the Approved Project would be less than significant. The IS/MND found no incidents of hazardous substances release on the Approved Project site. Less than significant impacts would occur.

The Approved Project site was found not to be within the boundaries of the Airport Environs Land Use Plan for John Wayne Airport, where land uses are regulated to minimize aviation-related hazards to people on the ground, and that the Approved Project would not cause significant aviation-related hazards. Additionally, the Approved Project would not involve changes to the local circulation system or traffic impacts that would interfere with implementation of the City of Orange's Emergency Operations Plan. Further, the Approved Project site was not identified to be located in a Wildland Fire Hazard Area; therefore, the Approved Project would not expose people or structures to a significant risk of loss, injury, or death involving wildland fires. No impacts would occur.

4.9.2 PROJECT ENVIRONMENTAL REVIEW

The information in this section is based partly on a regulatory agency environmental database search conducted by Environmental Data Resources, Inc. on June 10, 2021, and included as Appendix C to this Addendum.

Would the Project:

a) Create a significant hazard to the public or the environment through the routine transport, use, or disposal of hazardous materials?

No Substantial Change from Previous Analysis. Implementation of the Modified Project would involve similar routine transport, use, and disposal of hazardous materials compared to the Approved Project, as detailed in Section 3.0, Project Description. The Modified Project would not involve use of different or substantially larger amounts of hazardous materials than what was identified for the Approved Project. Consistent with the previous analysis for the Approved Project, compliance with existing federal, State, and local, regulations would reduce project hazardous materials impacts to less than significant. No new impacts would occur.

b) Create a significant hazard to the public or the environment through reasonably foreseeable upset and accident conditions involving the release of hazardous materials into the environment?

No Substantial Change from Previous Analysis. Consistent with the previous analysis for the Approved Project, hazardous materials would be transported and stored during Project construction activities in accordance with regulations, thus reducing hazards. Project operation is not expected to involve the use of substantial increased amounts of hazardous materials; thus, Modified Project development would not cause substantial hazards from accidental release of hazardous materials. No new significant impact would occur.

c) Emit hazardous emissions or handle hazardous or acutely hazardous materials, substances, or waste within one-quarter mile of an existing or proposed school?

No Substantial Change from Previous Analysis. Consistent with the previous analysis for the Approved Project, only one school, Prospect Elementary School at 379 North Virage Street, is within 0.25 mile of the Modified Project site. As discussed in Response to Threshold 4.9.2. (c); the Project will comply with all regulations for the transport, use, and disposal of hazardous materials; therefore, the Modified Project would not result in impacts related to emitting or handling hazardous materials near a school. No new impact would occur.

d) Be located on a site which is included on a list of hazardous materials sites compiled pursuant to Government Code Section 65962.5 and, as a result, would it create a significant hazard to the public or the environment?

No Substantial Change from Previous Analysis. A regulatory agency environmental database search was conducted by Environmental Data Resources, Inc. on June 10, 2021, to update the database searches conducted for the Approved Project. Search parameters were based on a one-mile radius of the approximate center of the Modified Project. These databases include both facilities that use, store, and/or generate hazardous materials; and those that have had a hazardous materials release. The complete list of databases and additional information regarding the identified sites can be found in the Environmental Data Resources (EDR) Report presented in Appendix C. The updated search identified the following listings:

- **IRWD - OPA 1 Well #408636 (678 Gravier Street).** This site is identified in the California Environmental Reporting System (CERS), which is a list of sites in the California Environmental Protection Agency (CalEPA) Regulated Site Portal which fall under the Hazardous Chemical Management, Hazardous Waste Onsite Treatment, Household Hazardous Waste Collection, Hazardous Waste Generator, and Resource Conservation and Recovery Act Large Quantity Hazardous Waste (RCRA LQ HW) Generator programs. This site is a Hazardous Waste Generator and Underground Storage Tank (UST). The facility has been cited for procedural violations by the City of Orange Fire Department; no releases have been reported. The site returned to compliance on September 13, 2018.
- **CAL MAT FACILITY #S102426039 (454 Prospect Street).** This site is identified in the California Environmental Reporting System (CERS), which is a list of sites in the CalEPA Regulated Site Portal which fall under the Hazardous Chemical Management, Hazardous Waste Onsite Treatment, Household Hazardous Waste Collection, Hazardous Waste Generator, and RCRA LQ HW Generator programs. This site is a LUST cleanup site. The cleanup status is completed and the case has been closed as of February 15, 1990.
- **EL MODENA HIGH SCHOOL #S109284357 (3920 East Spring Street).** This site is identified in the CERS, which is a list of sites in the CalEPA Regulated Site Portal which fall under the Hazardous Chemical Management, Hazardous Waste Onsite Treatment, Household Hazardous Waste Collection, Hazardous Waste Generator, and RCRA LQ HW Generator programs. This site is a LUST clean-up site. The cleanup status is completed, and the case has been closed as of December 29, 1992.
- **DANNY'S CLEANERS 2/CHAPMAN PATEL CLEANERS #S113147218 (3534 East Chapman Avenue).** This site is identified in the EnviroStor database with is the Department of Toxic Substance Control's (DTSC's) for tracking cleanup, permitting, enforcement, and investigation efforts at hazardous waste facilities and sites with known or suspected contamination issues. This site is undergoing a voluntary site cleanup program; no releases have been reported. The status is active as of 3/26/2020.

The first site is the Approved Project site at 678 Gravier Street. The facility has undergone a procedural violation only with no releases reported. The site is in full compliance as of September 13, 2018. Two of the listings, 3920 East Spring Street and 454 Prospect Street, document previous hazardous materials releases (LUST cases); however, the EDR report documents completed cleanup statuses and the closed cases for both sites. The final site at 3534 East Chapman Avenue is undergoing an active voluntary cleanup program with no reported releases. No hazardous materials releases are currently documented at any of the nearby sites, and those sites are not considered environmental concerns for the Modified Project site. Consistent with the previous analysis for the Approved Project, none of the four listings are considered to be environmental concerns for the Modified Project. No new impact would occur.

e) For a project located within an airport land use plan or, where such a plan has not been adopted, within two miles of a public airport or public use airport, would the project result in a safety hazard or excessive noise for people residing or working in the Project area?

No Substantial Change from Previous Analysis. Consistent with the previous analysis for the Approved Project, the Modified Project site is outside the Safety Compatibility Zones for John Wayne Airport, in which land uses are regulated to minimize aviation-related hazards to people on the ground. Therefore, Modified Project development would not cause substantial aviation-related hazards to people on the Modified Project site, and no new impact would occur.

f) Impair implementation of or physically interfere with an adopted emergency response plan or emergency evacuation plan?

No Substantial Change from Previous Analysis. Consistent with the previous analysis for the Approved Project, the Modified Project would not block roadways providing access to surrounding properties and would not impede emergency access to the Project site. All construction equipment and materials would be staged on the Project site during the duration of construction. During construction of the new driveway, traffic control would be present on North Gravier Street and may result in a temporary pedestrian sidewalk detour; however no road closures would be required. Compliance with **MM TR-1** (detailed in Section 4.17, Transportation) would reduce transportation impacts associated with construction and ensure the Modified Project would not interfere with an adopted emergency response plan or emergency evacuation plan during construction and long-term operation. No new impact would occur.

g) Expose people or structures, either directly or indirectly, to a significant risk of loss, injury or death involving wildland fires?

No Substantial Change from Previous Analysis. Consistent with the previous analysis for the Approved Project, the Modified Project site is not in or near a fire hazard severity zone mapped by the California Department of Forestry and Fire Protection (CAL FIRE 2021). The Modified Project site is in a built-out urban area lacking wildland vegetation. Modified Project development would not expose people or structures to wildfire risks, and no new impact would occur.

Conclusion

The impacts of the Modified Project would be consistent with the impacts identified for the previously Approved Project analyzed in the IS/MND. The Modified Project would not create a new significant impact or a substantial increase in the severity of previously identified effects. In regard to Section 15162 of the State CEQA Guidelines, the Modified Project (1) would not propose substantial changes; (2) would not have circumstantial changes when the Project is undertaken; (3) would bring about no new information of substantial importance that would (a) create new

significant impacts, (b) increase the severity of previously examined effects, or (c) determine that mitigation measures or alternatives previously found not to be feasible would, in fact, be feasible; or (4) introduce mitigation measures that are considerably different from those analyzed in the previous documents. For these reasons, no major revisions to the hazards and hazardous materials analysis provided in the IS/MND are required.

Mitigation Program

No mitigation for hazards and hazardous materials impacts was required in the IS/MND.

4.10 HYDROLOGY AND WATER QUALITY

4.10.1 SUMMARY OF PREVIOUS ENVIRONMENTAL REVIEW

Orange Park Acres Well Replacement Project Initial Study/Mitigated Negative Declaration

According to the IS/MND, the Approved Project is located in the Santa Ana River watershed, the site is under the jurisdiction of the SARWQCB and subject to the objectives, water quality standards, and BMPs requirements established in the Santa Ana River Basin Plan and Orange County DAMP. Further, the Approved Project would comply with all requirements of the NPDES; the Orange County Flood Control District (OCFCD) discharge permits; and the City of Orange Municipal Code Chapter 7.01, Water Quality and Stormwater Discharges (Orange 2021b).

The IS/MND determined that Approved Project would not violate any water quality standards or waste discharge requirements during construction or operational activities. Because Project construction would encompass less than one acre, the Project construction would not require the preparation of a formal SWPPP. However, the Approved Project would implement an erosion control plan to minimize runoff during construction. Additionally, all discharge water generated during construction would be disposed of in accordance with NPDES and OCFCD discharge permits. Operation of the Approved Project would not interfere with groundwater recharge as it introduces a negligible change in impervious surfaces and would not introduce a new long-term source of withdrawal of groundwater because it is intended to replace the existing Well OPA-3, therefore no significant lowering of groundwater levels would occur. Further, operation of the Approved Project would result in a minor increase in the amount of pumping compared with historic records. The maximum drawdown would be essentially unchanged.

According to the IS/MND, the Approved Project would not locate housing within a 100-year flood hazard area; is not within a 100- or 500-year flood zone area; would not directly affect the flow of a river or stream; and would not increase exposure to inundation by seiche, tsunami, or mudflow. The Approved Project would not substantially alter the existing drainage pattern of the site nor would it substantially change the impervious area on the Approved Project site. Therefore, the Approved Project would not substantially increase the volume or velocities of stormwater flow, contribute to the exceedance of storm water drainage capacities, or provide additional sources of pollutants. Therefore, the Approved Project would not expose people to a significant risk of loss, injury, or death involving flooding, including flooding as a result of the failure of a levee or dam.

4.10.2 PROJECT ENVIRONMENTAL REVIEW

Would the Project:

- a) *Violate any water quality standards or waste discharge requirements or otherwise substantially degrade surface or ground water quality?***

Construction

Consistent with the previous analysis for the Approved Project, the Modified Project would involve a minimal amount of ground disturbance on the Modified Project site primarily due to the demolition of the single-story residence at 660 North Gravier Street. However, because the Modified Project is the resumption of Well OPA-1, uses would be similar in nature and result in similar types and volumes of pollutants. The Modified Project site encompasses less than one acre, therefore, a SWPPP is not required. However, the Modified Project would implement an erosion control plan to minimize runoff during construction. Additionally, implementation of BMPs according to the Orange County DAMP and compliance with all requirements of the NPDES; the

OCFCD discharge permits; and the City of Orange Municipal Code Chapter 7.01, Water Quality and Stormwater Discharges (Orange 2021b) would reduce construction storm water pollution impacts to less than significant, and no new impact would occur.

Operation

Due to the similarities in proposed uses, operation of the Modified Project would generate the same types of pollutants as the Approved Project. During operation, IRWD will implement BMPs and comply with all State, regional, and local regulations, including the City of Orange Municipal Code Chapter 7.01, Water Quality and Stormwater Discharges (Orange 2021b) which states the Public Works Department shall review the Modified project plans and impose terms, conditions, and requirements on the project in accordance with the NPDES Permit, the DAMP and the Local Implementation Plan (LIP) if required (Orange 2021b). Therefore, operational water quality impacts of the Modified Project would be less than significant which is consistent with the Approved Project, and no new significant impact would occur.

b) Substantially decrease groundwater supplies or interfere substantially with groundwater recharge such that the project may impede sustainable groundwater management of the basin?

No Substantial Change from Previous Analysis. The Modified Project site is located within the Orange County Groundwater Basin (OCWD 2015); however, consistent with the Approved Project, the Modified Project site is not used for intentional groundwater recharge. The Modified Project uses are similar to the Approved Project, namely, to supply groundwater for the IRWD service areas. The Modified Project site receives water for operation by the City of Orange Public Works Water Division (Orange 2021). As discussed previously in Section 2.0 Project Description, the facility will be visited by IRWD for routine inspection and maintenance on a daily basis consistent with the Approved Project conditions. Therefore, the Project's requirements for operational water is minimal and can be handled by the City of Orange's water division. Additionally, development would minimally increase impervious areas on site and thus would not decrease groundwater recharge, compared to Approved Project development.

However, as discussed in Response to Threshold 4.10.1. (a) operation of the Modified Project would result in an increase in the amount of pumping from about 900 AFY to 3,200 AFY. The City of Orange and IRWD will enter into an agreement for the allowable groundwater extraction from Well OPA-1. During operation, therefore, operational groundwater extraction of the Modified Project would be greater than the Approved Project, but would not exceed the identified supply for the local area and would not substantially decrease groundwater supply impacts would be less than significant with regards to groundwater supplies and groundwater management; and no new impacts would occur.

c) Substantially alter the existing drainage pattern of the site or area, including through the alteration of the course of a stream or river or through the addition of impervious surfaces, in a manner which would:

i) result in substantial erosion or siltation on- or off-site;

No Substantial Change from Previous Analysis. Consistent with the previous analysis for the Approved Project, Modified Project development would not substantially change the drainage pattern on site. Similar to the Approved Project, the Modified Project would implement BMPs and comply will applicate State, regional, and local regulations and procedures. BMPs include preparation and implementation of an erosion control plan. Thus, Modified Project development

would not increase erosion or siltation compared to the Approved Projects, and no new impact would occur.

ii) substantially increase the rate or amount of surface runoff in a manner which would result in flooding on- or offsite;

No Substantial Change from Previous Analysis. The development scenario would involve the expansion of the facility onto the IRWD-owned property at 660 North Gravier Street to the south. The property has existing impervious surfaces in the form of the existing single-story residence that will be demolished; however, the Modified Project would increase impervious surfaces over existing conditions. Despite this increase, the Modified Project would maintain pervious surface areas in the form of landscaping and screening along the site's southern, eastern and western perimeters. Additionally, the Modified Project includes design features intended to direct drainage away from the structures and minimize potential for on- and off-site flooding through construction of adequate sloping for surface drainage, installation of landscaping designed to minimize water infiltration, and installation of gutters and downspouts as appropriate to accommodate anticipated drainage (AECOM 2021). Although the Modified Project would increase the amount of impervious surface on the site, implementation of these features would ensure that runoff would not cause flooding on- or off-site. Consistent with the Approved Project, surface runoff related to Modified Project development would not result in flooding on- or off-site. No new impact would occur.

iii) create or contribute runoff water which would exceed the capacity of existing or planned stormwater drainage systems or provide substantial additional sources of polluted runoff; or

No Substantial Change from Previous Analysis. Consistent with the previous analysis for the Approved Project, the Modified Project would limit discharges of runoff off site to no more than the existing runoff rate, pursuant to OCFCD and the City of Orange's Municipal Code Chapter 7.01, Water Quality and Stormwater Discharges requirements (Orange 2021b). Thus, Modified Project development would not generate runoff exceeding the capacities of stormwater drainage systems, and no new significant impact would occur.

iv) impede or redirect flood flows?

No Substantial Change from Previous Analysis. Consistent with the previous analysis for the Approved Project, the Modified Project site is outside 100-year flood zones, and Modified Project development would not impede or redirect flood flows. No new impact would occur.

d) In flood hazard, tsunami, or seiche zones, risk release of pollutants due to project inundation?

No Substantial Change from Previous Analysis. Consistent with the previous analysis for the Approved Project, the Modified Project site is outside 100- or 500-year flood zone area (AECOM 2021). Modified Project development would not risk release of pollutants due to site flooding in a 100-year flood zone. Additionally, the Modified Project site is outside tsunami hazard zones (CGS 2021), and Modified Project development would not risk release of pollutants due to site flooding in a tsunami hazard zone. A seiche is a surface wave created when an inland water body is shaken, usually by an earthquake. Although seiches have not historically occurred within the City of Orange, it is possible that a seiche could occur within the Santiago Creek Recharge Basin. Similar to the Approved Project, the Modified Project does not involve the construction of any habitable buildings or structures that would contribute to inundation by seiche and the site is at a higher elevation. Impacts would be less than significant; no new impacts would occur.

e) Conflict with or obstruct implementation of a water quality control plan or sustainable groundwater management plan?

No Substantial Change from Previous Analysis. The Water Quality Control Plan for the Santa Ana Basin was updated by the SARWQCB in 2016. The Groundwater Management Plan (GWMP) for the Main Orange County Groundwater Basin was updated by the OCWD in 2015. Consistent with the previous analysis for the Approved Project, Modified Project development would comply with all regulations and BMP requirements established in the Santa Ana River Basin Plan and Orange County DAM. Further, the Approved Project would comply with all requirements of the NPDES; the OCFCD discharge permits; and the City of Orange Municipal Code Chapter 7.01 Water Quality and Stormwater Discharges (Orange 2021b).

Additionally, the Modified Project would enter into a new Agreement with City of Orange, which will dictate the amount of groundwater extraction allowed from the Well OPA-1. Therefore, the Modified Project would not impact groundwater recharge or groundwater supply and would not substantially impact groundwater quality and thus would not conflict with the GWMP. Impacts would be less than significant, and no new impacts would occur.

f) Result in the potential for discharge of stormwater to affect the beneficial uses of the receiving waters from construction activities or post-construction activities?

No Substantial Change from Previous Analysis. Consistent with the Approved Project, the Modified Project, all discharge water generated during construction would be disposed of in accordance with NPDES and OCFCD discharge permits. Additionally, BMPs would be developed for the Modified Project and implemented to limit the introduction of pollutants to the environment, ground surface, or offsite drainages during construction. These include preparation and implementation of a Spill Prevention Plan and an erosion control plan. Therefore, the Modified Project would not result in the potential for discharge of stormwater to affect the beneficial uses of the receiving waters (Santiago Creek Channel) and impacts would be less than significant.

g) Result in a potential for discharge of stormwater pollutants from areas of material storage, vehicle or equipment fueling, vehicle or equipment maintenance (including washing), waste handling, hazardous materials handling or storage, delivery areas, loading docks or other outdoor work areas?

No Substantial Change from Previous Analysis. Consistent with the previous analysis for the Approved Project, and discussed in Section 4.9 Hazards and Hazardous Materials, the Modified Project construction activities would involve limited use of hazardous materials, and operation would involve the routine transport, use, and storage of hazardous materials for maintenance of the water treatment system. IRWD will comply with all State, regional, and local permits and regulations including the development of a spill prevention and control plan which would reduce the potential for an accidental release of petroleum products and/or hazardous materials which would result in stormwater pollutants. Consistent with the Approved Project, the Modified Project would not involve vehicle or equipment fueling, vehicle or equipment maintenance, loading docks, or other outdoor areas. Therefore, the Modified Project would result in a low potential for discharge of stormwater pollutants from construction and operational activities, and impacts would be less than significant.

h) Create the potential for significant changes in the flow velocity or volume of stormwater runoff to cause environmental harm?

No Substantial Change from Previous Analysis. As discussed in Response to Threshold 4.10.1. (c)(ii), the property has existing impervious surfaces in the form of the existing

single-story residence that will be demolished; however, the Modified Project would increase impervious surfaces over existing conditions. Despite this increase, the Modified Project would maintain pervious surface areas in the form of landscaping and screening along the site's southern, eastern and western perimeters. Additionally, the Modified Project includes design features intended to direct drainage away from the structures and minimize potential for on- and off-site flooding through construction of adequate sloping for surface drainage, installation of landscaping designed to minimize water infiltration, and installation of gutters and downspouts as appropriate to accommodate anticipated drainage (AECOM 2021). Although the Modified Project would increase the amount of impervious surface on the site, implementation of these features would ensure that runoff flow velocity would not cause environmental harm. Consistent with the previous analysis for the Approved Project, construction and operation of the proposed Project would not create the potential for significant changes in the flow velocity or volume of stormwater runoff to cause environmental harm. Impacts would be less than significant; no new mitigation is required.

Conclusion

The impacts of the Modified Project would be consistent with the impacts identified for the previously Approved Project analyzed in the IS/MND. The Modified Project would not create a new significant impact or a substantial increase in the severity of previously identified effects. In regard to Section 15162 of the State CEQA Guidelines, the Modified Project (1) would not propose substantial changes; (2) would not have circumstantial changes when the Project is undertaken; (3) would bring about no new information of substantial importance that would (a) create new significant impacts, (b) increase the severity of previously examined effects, or (c) determine that mitigation measures or alternatives previously found not to be feasible would, in fact, be feasible; or (4) introduce mitigation measures that are considerably different from those analyzed in the previous documents. For these reasons, no major revisions to the hydrology and water quality analysis provided in the IS/MND are required.

Mitigation Program

No mitigation was required for hydrology and water quality impacts was required in the IS/MND.

4.11 LAND USE AND PLANNING

4.11.1 SUMMARY OF PREVIOUS ENVIRONMENTAL REVIEW

Orange Park Acres Well Replacement Project Initial Study/Mitigated Negative Declaration

According to the IS/MND, the Approved Project would expand the infrastructure use on a site that is primarily intended for residential land use; however, infrastructure projects are generally accommodated within most non-infrastructure land use designations. The Approved Project is consistent with the goals, policies, and objectives of the General Plan in that the proposed facilities would provide upgrades to existing water infrastructure to provide adequate service to residents.

Further, the Project site is not within a NCCP/HCP and would not conflict with any applicable HCP or NCCP, and no impact was identified.

4.11.2 PROJECT ENVIRONMENTAL REVIEW

Would the Project:

a) Physically divide an established community?

No Substantial Change from Previous Analysis. Consistent with the previous analysis for the Approved Project, implementation of the Modified Project would occur within the boundaries of the existing IRWD property. The Modified Project site is located within the established community, however, development would not extend outside of IRWD's property that is currently used for utility purposes. Therefore, the Modified Project would not physically divide an established community. No impact would occur.

b) Cause a significant environmental impact due to a conflict with any land use plan, policy, or regulation adopted for the purpose of avoiding or mitigating an environmental effect?

No Substantial Change from Previous Analysis. The existing General Plan land use designation for the Modified Project site is LDR (Orange 2015). As discussed in Response to Threshold 4.11.2. (a), the Modified Project site is located entirely within IRWD-owned property and is surrounded by a residential community. Typical development in the project vicinity is R-1-7 Single Family Residential with a 7,000-sf minimum lot size per the City of Orange Zoning Ordinance (Orange 2020). Implementation of the Modified Project, the wellhead treatment, would enable IRWD to resume operation of the existing Well facility. The Modified Project would involve demolition of the residential use at 660 North Gravier Street and expand the infrastructure use on a site that is primarily intended for residential land use; however, infrastructure projects are generally accommodated within most non- infrastructure land use designations. The Modified Project helps accomplish the City of Orange Land Use Element Policy 1.1 to maintain a land use structure that balances jobs and housing with available infrastructure and public and human services (Orange 2015b). Therefore, though the Modified Project does not necessarily further the intent of the LDR land use designation, it also does not conflict with it. Therefore, impacts are less than significant; no new impacts would occur.

Conclusion

The impacts of the Modified Project would be consistent with the impacts identified for the previously Approved Project analyzed in the IS/MND. The Modified Project would not create a new significant impact, nor would it create a substantial increase in the severity of previously

identified effects. In regard to Section 15162 of the State CEQA Guidelines, the Modified Project (1) would not propose substantial changes; (2) would not have circumstantial changes when the Project is undertaken; (3) would bring about no new information of substantial importance that would (a) create new significant impacts, (b) increase the severity of previously examined effects, or (c) determine that mitigation measures or alternatives previously found not to be feasible would, in fact, be feasible; or (4) introduce mitigation measures that are considerably different from those analyzed in the previous documents. For these reasons, no major revisions to the land use and planning analysis provided in the IS/MND are required.

Mitigation Program

No mitigation for land use and planning impacts was required in the IS/MND.

4.12 MINERAL RESOURCES

4.12.1 SUMMARY OF PREVIOUS ENVIRONMENTAL REVIEW

Orange Park Acres Well Replacement Project Initial Study/Mitigated Negative Declaration

According to the IS/MND, the Approved Project site overlays a regionally significant aggregated resource area. However, the land use designation is not Resource Area nor is it zoned for sand and gravel extraction, which would allow for mining of aggregate resources. The IS/MND noted that neither the Approved Project site or surrounding neighborhood are delineated on a local general plan, specific plan, or other land use plan as an important mineral resource recovery site. Therefore, construction and operation of the Approved Project would not contribute to the loss of availability of a known mineral resource, and impacts would be less than significant.

4.12.2 PROJECT ENVIRONMENTAL REVIEW

Would the Project:

a) Result in the loss of availability of a known mineral resource that would be of value to the region and the residents of the state?

No Substantial Change from Previous Analysis. Consistent with the previous analysis for the Approved Project, the Modified Project site is developed with residential and infrastructure uses and is located in an urbanized area of the City of Orange. The Modified Project site is located in a regionally significant aggregate resource area; however, the land use designation is not a Resource Area nor is it zoned for sand and gravel extraction, which would allow for mining of aggregate resources. The Modified Project site is also not located in a designated Resource Area for minerals or zoned for sand and gravel extraction in the City of Orange (Orange 2015a). Similar to the Approved Project, the Modified Project would not contribute to the loss of availability of a known mineral resource, and no new impact would occur.

b) Result in the loss of availability of a locally-important mineral resource recovery site delineated on a local general plan, specific plan or other land use plan?

No Substantial Change from Previous Analysis. As discussed in Response to Threshold 4.12.2. (a), the Modified Project site is not a designated Resource Area for minerals in the City of Orange (Orange 2015a). Additionally, the current land use designation is Low Density Residential and zoned R-1-7 Single Family residential. Therefore, development of the Modified Project would not cause a loss of availability of locally-important mineral resources, and no new impact would occur.

Conclusion

The impacts of the Modified Project would be consistent with the impacts identified for the previously Approved Project analyzed in the IS/MND. The Modified Project would not create a new significant impact or a substantial increase in the severity of previously identified effects. In regard to Section 15162 of the State CEQA Guidelines, the Modified Project (1) would not propose substantial changes; (2) would not have circumstantial changes when the Project is undertaken; (3) would bring about no new information of substantial importance that would (a) create new significant impacts, (b) increase the severity of previously examined effects, or (c) determine that mitigation measures or alternatives previously found not to be feasible would, in fact, be feasible; or (4) introduce mitigation measures that are considerably different from those analyzed in the

previous documents. For these reasons, no major revisions to the mineral resources analysis provided in the IS/MND are required.

Mitigation Program

No mitigation for mineral resources impacts was required in the IS/MND.

4.13 NOISE

4.13.1 SUMMARY OF PREVIOUS ENVIRONMENTAL REVIEW

Orange Park Acres Well Replacement Project Initial Study/Mitigated Negative Declaration

The IS/MND concluded that Approved Project construction would generate noise exceeding construction noise thresholds at the nearest noise-sensitive land uses. Construction would comply with the City of Orange's Municipal Code time frames for demolition of Well OPA-3 and all other construction activities (with the exception of well drilling) and would meet City or Orange noise standards (Orange 2021b). However, for well drilling, noise levels are likely to exceed established noise levels in the City of Orange's Noise Ordinance. As part of the Project and prior to construction, IRWD will secure, as determined to be necessary, a variance from the City of Orange's Noise Variance Board that would exempt construction of IRWD Well OPA-1 from the City's 8:00 PM to 7:00 AM noise and construction hours limitations to accommodate continuous drilling and well testing over a 24-hour period when necessary. While the variance may address the exceedance of the noise standards, noise from well drilling and construction would continue to be elevated for surrounding receptors during limited periods of time. With the inclusion of 24-foot sound walls during well drilling to satisfy project design features and in compliance with **MM NOI-1**, impacts would be less than significant.

Operation of the Approved Project would not generate noise exceeding City of Orange's standards at the nearest noise receptors. Under current operating conditions (before the Approved Project), the pump at existing Well OPA-3 site is not contained within an enclosed structure and produces noise. The Approved Project would be designed and constructed in a manner that will likely improve noise levels by locating pumps (used for potable water extraction and transference) within fully enclosed structures designed to attenuate noise. **MMs NOI-2** and **NOI-3** would be implemented to further reduce potential operational noise impacts to less-than-significant levels.

4.13.2 PROJECT ENVIRONMENTAL REVIEW

Noise

"Sound" is a vibratory disturbance created by a moving or vibrating source and is capable of being detected. "Noise" is defined as sound that is loud, unpleasant, unexpected, or undesired and may therefore be classified as a more specific group of sounds. The effects of noise on people can include general annoyance; interference with speech communication; sleep disturbance; and, in the extreme, hearing impairment (Caltrans 2013).

Sound pressure levels are described in units called the decibel (dB). dBs are measured on a logarithmic scale. A doubling of the energy of a noise source (such as doubling of traffic volume) would increase the noise level by 3 dB. The human ear is not equally sensitive to all frequencies within the sound spectrum. To accommodate this phenomenon, the A-scale was devised; the A-weighted decibel scale (dBA) approximates the frequency response of the average healthy ear when listening to most ordinary everyday sounds and is used in this analysis.

Human perception of noise has no simple correlation with acoustical energy. Due to subjective thresholds of tolerance, the annoyance of a given noise source is perceived very differently from person to person. The most common sounds vary between 40 dBA (very quiet) to 100 dBA (very loud). Normal conversation at 3 feet is approximately 60 dBA, while loud jet engine noises at

1,000 feet equate to 100 dBA, which can cause serious discomfort. Table 4-5 shows the relationship of various noise levels in dBA to commonly experienced noise events.

**TABLE 4-5
NOISE LEVELS FOR COMMON EVENTS**

Common Outdoor Activities	Noise Level (dBA)	Common Indoor Activities
–	110	Rock Band
Jet fly-over at 300 m (1,000 ft)	100	–
Gas lawn mower at 1 m (3 ft)	90	–
Diesel truck at 15 m (50 ft) at 80 km/hr (50 mph)	80	Food blender at 1 m (3 ft); garbage disposal at 1 m (3 ft)
Noisy urban area, daytime gas lawn mower at 30 m (100 ft)	70	Vacuum cleaner at 3 m (10 ft)
Commercial area, heavy traffic at 90 m (300 ft)	60	Normal speech at 1 m (3 ft)
Quiet urban daytime	50	Large business office, dishwasher in next room
Quiet urban nighttime	40	Theater, large conference room (background)
Quiet suburban nighttime	30	Library
Quiet rural nighttime	20	Bedroom at night, concert hall (background)
–	10	Broadcast/recording studio
Lowest threshold of human hearing	0	Lowest threshold of human hearing
dBA: A-weighted decibels; m: meter; ft: feet; km/hr: kilometers per hour; mph: miles per hour		
Source: Caltrans 2013.		

Two noise sources do not “sound twice as loud” as one source. As stated above, a doubling of noise sources results in a noise level increase of 3 dBA. It is widely accepted that (1) the average healthy ear can barely perceive changes of a 3 dBA increase or decrease, (2) a change of 5 dBA is readily perceptible, and (3) an increase (decrease) of 10 dBA sounds twice (half) as loud (Caltrans 2013).

From the source to the receiver, noise changes both in the level and frequency spectrum. The most obvious change is the decrease in noise level as the distance from the source increases. Sound from a small localized source (approximating a “point” source) radiates uniformly outward as it travels away from the source in a spherical pattern. For point sources, such as heating, ventilation, and air conditioning (HVAC) units or construction equipment, the sound level attenuates (or drops off) at a rate of 6 dBA for each doubling of distance (i.e., if the noise level is 70 dBA at 25 feet, it is 64 dBA at 50 feet). Vehicle movement on a road makes the source of the sound appear to emanate from a line (line source) rather than a point when viewed over some time interval. The sound level attenuates or drops off at a rate of 3 dBA per doubling of distance for line sources.

A large object in the path between a noise source and a receiver can significantly attenuate noise levels at that receiver location. The amount of attenuation provided by this “shielding” depends on the size of the object and the frequencies of the noise levels. Natural terrain or landform features as well as man-made features (e.g., buildings and walls) can significantly alter noise exposure levels. For a noise barrier to work, it must be high enough and long enough to block the view from the receiver to a road or to the noise source. Effective noise barriers can reduce outdoor noise levels at the receptor by up to 15 dBA.

Several rating scales (or noise “metrics”) exist to analyze effects of noise on a community. These scales include the equivalent noise level (L_{eq}), including L_{max} and L_{min} , which are respectively the

highest and lowest A-weighted sound levels that occur during a noise event, and the Community Noise Equivalent Level (CNEL). Average noise levels over a period of minutes or hours are usually expressed as dBA L_{eq} , which is the equivalent noise level for that period of time. The period of time averaging may be specified; for example, $L_{eq(3)}$ would be a three-hour average. Noise of short duration (i.e., substantially less than the averaging period) is averaged into ambient noise during the period of interest. Thus, a loud noise lasting many seconds or a few minutes may have minimal effect on the measured sound level averaged over a one-hour period.

To evaluate community noise impacts, CNEL was developed to account for human sensitivity to nighttime noise. CNEL represents the 24-hour average sound level with a penalty for noise occurring at night. The CNEL computation divides a 24-hour day into three periods: daytime (7:00 AM to 7:00 PM), evening (7:00 PM to 10:00 PM), and nighttime (10:00 PM to 7:00 AM). The evening sound levels are assigned a 5-dBA penalty, and the nighttime sound levels are assigned a 10-dBA penalty prior to averaging with daytime hourly sound levels.

Vibration

Vibration is an oscillatory motion through a solid medium in which the motion's amplitude can be described in terms of displacement, velocity, or acceleration. Vibration is normally associated with activities such as railroads or vibration-intensive stationary sources, but can also be associated with construction equipment such as jackhammers, pile drivers, and hydraulic hammers. Vibration displacement is the distance that a point on a surface moves away from its original static position. The instantaneous speed that a point on a surface moves is described as the velocity, and the rate of change of the speed is described as the acceleration. Each of these descriptors can be used to correlate vibration to human response, building damage, and acceptable equipment vibration levels. During construction of a project, the operation of construction equipment can cause groundborne vibration. During the operational phase of a project, receptors may be subject to levels of vibration that can cause annoyance due to noise generated from vibration of a structure or items within a structure. Analysis of this type of vibration is best measured in velocity and acceleration.

The three main wave types of concern in the propagation of groundborne vibrations are surface or Rayleigh waves, compression or P-waves, and shear or S-waves.

- Surface or Rayleigh waves travel along the ground surface. They carry most of their energy along an expanding cylindrical wave front, similar to the ripples produced by throwing a rock into a lake. The particle motion is more or less perpendicular to the direction of propagation (known as retrograde elliptical).
- Compression or P-waves are body waves that carry their energy along an expanding spherical wave front. The particle motion in these waves is longitudinal, in a push-pull motion. P-waves are analogous to airborne sound waves.
- Shear or S-waves are also body waves, carrying their energy along an expanding spherical wave front. Unlike P-waves, however, the particle motion is transverse, or perpendicular to the direction of propagation.

The peak particle velocity (ppv) or the root mean square (rms) velocity is usually used to describe vibration amplitudes. The ppv is defined as the maximum instantaneous peak of the vibration signal and the rms is defined as the square root of the average of the squared amplitude of the signal. The ppv is more appropriate for evaluating potential building damage and also used for evaluating human response.

The units for ppv velocity are normally inches per second (in/sec). Often, vibration is presented and discussed in dB units in order to compress the range of numbers required to describe the vibration. In this study, all ppv velocity levels are in in/sec and all vibration levels are in dB relative to one microinch per second. The threshold of perception is approximately 0.3 ppv. Typically, groundborne vibration generated by human activities attenuates rapidly with distance from the source of the vibration. Even the more persistent Rayleigh waves decrease relatively quickly as they move away from the source of the vibration. Manmade vibration problems are, therefore, usually confined to short distances (500 feet or less) from the source.

Construction generally includes a wide range of activities that can generate groundborne vibration. In general, blasting and demolition of structures generate the highest vibrations. Heavy trucks can also generate groundborne vibrations, which vary depending on vehicle type, weight, and pavement conditions. Potholes, pavement joints, discontinuities, differential settlement of pavement, and other anomalies all increase the vibration levels from vehicles passing over a road surface. Construction vibration is normally of greater concern than vibration of normal traffic on streets and freeways with smooth pavement conditions. Trains generate substantial quantities of vibration due to their engines, steel wheels, and heavy loads.

Existing Conditions

Noise Measurements

The existing noise environment at the Project site is primarily influenced by vehicular generated noise on nearby roads. The existing Project site has an enclosed pump/electrical building, chemical building, and surge tank. The noise operations of the site have been documented to yield noise levels of 43 dBA along the north and west property lines of the Project site (AECOM 2021). For the purpose of this noise analysis, the study area includes the areas immediately adjacent to the Project site, and the land uses adjacent to the roadway segments where the Project adds vehicular trips to the roadway system.

Noise-Sensitive Receptors

The State of California defines noise-sensitive receptors as those land uses that require serenity or are otherwise adversely affected by noise events or conditions (State of California 2015). Noise-sensitive land uses typically include residences, hospitals, churches, schools, and libraries, which could all be adversely affected by an increase in noise levels. Noise sensitive receptors in the vicinity of the Modified Project site include the following: a single-family residence is located immediately north of the Project site at 680, North Gravier Street; four single-family residences located immediately west of the Project site (641, 649, 653, and 659 North Oxford Court); a single-family residence at 642 North Gravier Street located immediately south of the Project site; and three single-family residences located across North Gravier Street to the east of the Project site (3704 East Bond Avenue, and 653 and 655 North Gravier Street).

Regulatory Setting

Public agencies have established noise guidelines and standards to protect citizens from potential hearing damage and various other adverse physiological and social effects associated with noise. For the evaluation of potential noise impacts, this analysis assumes compliance with the City of Orange's Municipal Code (Orange 2021b) and the City of Orange's Noise Element (Orange 2010).

City of Orange Municipal Code

The following sections of the OMC apply to the Project:

- Chapter 8.24.040 Exterior Standards
 - A. The following noise standards for fixed noise sources, unless otherwise specifically indicated, shall apply to all residential property:

OMC Table 8.24.040 Exterior Noise Standards

	Noise Level	Time Period
Hourly Average (L_{eq})	55 dB (A)	7:00 a.m.–10:00 p.m.
	50 dB (A)	10:00 p.m.–7:00 a.m.
Maximum Level	70 dB (A)	7:00 a.m.–10:00 p.m.
	65 dB (A)	10:00 p.m.–7:00 a.m.

- B. It is unlawful for any person at any location within the City to create any noise, or to allow the creation of any noise on property owned, leased, occupied or otherwise controlled by such person, which causes the noise level when measured on any other residential property to exceed the noise standards identified in Table 8.24.040. For multi-family residential or mixed use developments located within the City’s Urban Mixed Use, Neighborhood Mixed Use, Old Towne Mixed Use or Medium Density Residential General Plan land use districts, exterior noise standards shall apply to common recreation areas only and shall not apply to private exterior space (such as a private yard, patio, or balcony).
 - C. In the event the ambient noise level exceeds the noise standards identified in Table 8.24.040 of this section, the “adjusted ambient noise level” shall be applied as the noise standard. In cases where the noise standard is adjusted due to a high ambient noise level, the noise standard shall not exceed the “adjusted ambient noise level”, or 70 dB (A), whichever is less. In cases where the ambient noise level is already greater than 70 dB (A), the ambient noise level shall be applied as the noise standard.
 - D. Each of the noise limits specified in Table 8.24.040 shall be reduced by 5 dB(A) for impact or simple tone noises, recurring impulsive noises, or for noises consisting of speech or music.
- Chapter 8.24.050 Exemptions from Chapter Provisions

The following activities shall be exempted from the provisions of this chapter:

- A. School bands, school athletic and school entertainment events;
- B. Outdoor gatherings, public dances, shows, and sporting and entertainment events provided such events are conducted pursuant to any permit requirements established by the City;

- C. Activities conducted on public parks, public playgrounds, and public or private school grounds;
- D. Any mechanical device, apparatus or equipment used, related to or connected with emergency machinery, vehicle or work;
- E. Noise sources associated with construction, repair, remodeling, or grading of any real property, provided said activities take place between the hours of 7:00 a.m. and 8:00 p.m. on any day except for Sunday or a Federal holiday, or between the hours of 9:00 a.m. and 8:00 p.m. on Sunday or a Federal holiday. Noise generated outside of the hours specified are subject to the noise standards identified in Table 8.24.040;
- F. All mechanical devices, apparatus or equipment which are utilized for the protection or salvage of agricultural crops during periods of potential or actual frost damage or other adverse weather conditions;
- G. Noise sources associated with agricultural operations provided such operations take place between the hours of 7:00 a.m. and 8:00 p.m. on any day except Sunday or a Federal holiday, or between the hours of 9:00 a.m. and 8:00 p.m. on Sunday or a Federal holiday;
- H. Noise sources associated with agricultural pest control through pesticide application, provided that the application is made in accordance with restricted material permits issued by or regulations enforced by the Agricultural Commissioner;
- I. Noise sources associated with the maintenance of real property, provided such activities take place between the hours of 7:00 a.m. and 8:00 p.m. on any day except Sunday or a Federal holiday, or between the hours of 9:00 a.m. and 8:00 p.m. on Sunday or a Federal holiday. Operation of leaf blowers are regulated under OMC Chapter 8.26;
- J. Industrial or commercial noise affecting residential units, when the residential unit is associated with said industrial or commercial use (e.g. caretaker's dwellings);
- K. Any maintenance or construction activity undertaken by a public agency or utility within street right of way;
- L. Mobile noise sources including but not limited to operational noise from trains, or automobiles or trucks traveling on roadways. Transportation noise as related to noise/land use compatibility is subject to the City's General Plan Noise Element;
- M. Any activity to the extent regulation thereof has been preempted by State or Federal Law.

City of Orange General Plan

The *City of Orange General Plan* Noise Element has established goals/policies to manage the noise impact throughout the City of Orange. The pertinent goals are:

Industrial Noise

- Goal 6.0: Minimize Industrial activity noise in residential areas and near noise-sensitive land uses.
- Policy 6.1: Encourage the design and constructions of industrial uses to minimize excessive noise through project design features that include noise control.
- Policy 6.2: Encourage industrial uses to locate vehicular traffic and operations away from abutting residential zones as much as possible.

Construction, Maintenance and Nuisance Noise

- Goal 7.0: Minimize construction, maintenance vehicle and nuisance noise in residential areas and near noise-sensitive land uses.
- Policy 7.1: Schedule City maintenance and construction projects so that they generate noise during less sensitive hours.
- Policy 7.2: Require developers and contractors to employ noise minimizing techniques during construction and maintenance operations.
- Policy 7.3: Limit the hours of construction and maintenance operations located adjacent to noise-sensitive land uses.
- Policy 7.4: Encourage limitations on the hours of operations and deliveries for commercial, mixed-use, and industrial uses abutting residential zones.

Impact Analysis

Would the Project:

- a) ***Generation of a substantial temporary or permanent increase in ambient noise levels in the vicinity of the project in excess of standards established in the local general plan or noise ordinance, or applicable standards of other agencies?***

No Substantial Change from Previous Analysis.

Construction Noise

The Project involves demolition of an existing single-family residence, the construction of on-site water treatment systems and a concrete recessed pit. The residential land uses proximate to the Project site would be subject to elevated noise levels due to the operation of construction equipment. Construction activities are carried out in discrete steps, each of which has its own mix of equipment and, consequently, its own noise characteristics. Construction phases may include pavement cutting and removal, trenching, pipeline construction, backfilling, and water treatment infrastructure construction. Construction of the Project would be limited to weekdays between 7:00 AM to 7:00 PM, with no activity at night or on weekends or federal holidays.

Construction noise levels reported in the United States Environmental Protection Agency's *Noise from Construction Equipment and Operations, Building Equipment, and Home Appliances* were

used to estimate future construction noise levels for the Project (USEPA 1971). Typically, the estimated construction noise levels are governed primarily by equipment that produces the highest noise levels. Construction noise levels for each generalized construction phase (i.e., ground clearing/demolition, excavation, foundation construction, paving, and site cleanup) are based on a typical construction equipment mix for a public works project and do not include use of atypical and/or vibration-intensive equipment (e.g., impact pile drivers). All construction equipment is anticipated to be fitted with the original equipment manufacturer or manufacturer approved equivalent mufflers or intake silencers to maintain, at minimum, published noise emission levels. The duration of the construction phases vary due to the anticipated construction needs.

The degree to which noise-sensitive receptors are affected by construction activities depends heavily on their proximity. Estimated noise levels at the nearest noise sensitive uses attributable to the development of the Project site are shown in Table 4-6.

**TABLE 4-6
ESTIMATED CONSTRUCTION NOISE LEVELS AT RECEPTORS**

Construction Phase	Noise Level at Closest Distance (dBA L _{eq})	Noise Level at Average Distance (dBA L _{eq})
North Property Line		
Distance (ft)	124	160
Ground Clearing/Demolition	76	74
Grading/Excavation	70	68
Foundation/Construction	70	68
Paving and Site Cleanup	76	74
West Property Line		
Distance (ft)	7	60
Ground Clearing/Demolition	101	82
Grading/Excavation	95	76
Foundation/Construction	95	76
Paving and Site Cleanup	101	82
South Property Line		
Distance (ft)	15	50
Ground Clearing/Demolition	94	84
Grading/Excavation	88	78
Foundation/Construction	88	78
Paving and Site Cleanup	94	84
East Property Line (Residences East of North Gravier Street)		
Distance (ft)	60	110
Ground Clearing/Demolition	82	77
Grading/Excavation	76	71
Foundation/Construction	76	71
Paving and Site Cleanup	82	77
dBA: A-weighted decibels; L _{eq} : Equivalent Noise Level; ft: feet; N/A: not applicable		
Source: Noise calculations in Appendix D.		

Table 4-6 shows the Modified Project related construction noise level exposure at both the closest and average distances from offsite uses. While individual pieces of construction equipment may operate at the closest distance, the projected noise created from construction is a composite of

heavy equipment pieces working together and the physical limitations of proximity due to the size of the equipment would preclude all pieces working at the most proximate location. Noise levels for the closest distances represent the noise levels from construction occurring at the closest point of the Modified Project site to the closest point of the property line of the nearest land use/receptor. Noise levels at the closest distances would occur only intermittently because construction equipment moves around the site and is at the site boundary for only short periods of time. The average distance noise levels represent the noise exposure to sensitive uses based on the distance from the center of the on-site area to the closest property line of a noise sensitive use/receptor. Noise levels at the receptor sites would be reduced as the listener moves away from the Project boundary or is shielded by structures in the receptor area. Noise levels from anticipated Project-related construction activities for the Modified Project site are anticipated to range from 70 to 101 dBA L_{eq} for the closest noise levels and from 68 to 84 dBA L_{eq} for the average distance noise levels depending on the site selected. Noise level reductions from existing masonry walls and structures were not included.

The City of Orange does not have quantitative construction noise limits. As described above, the City of Orange Municipal Code prescribes specific time periods for construction activities that generate noise. Also, as noted above, the City of Orange considers the primary method of restricting noise from construction is through limiting the hours in which construction activity is permitted to the least noise sensitive portions of the day. In addition, the construction duration is approximately 6 months which is generally short for construction activities. Because the Modified Project would not involve construction equipment that generate extremely high magnitudes of noise such as impact pile driving, would be relative short in duration, and would not occur during the evening and night-time periods of the day when people are especially sensitive to noise, there would be a less than significant impact. Although no mitigation is required, consistent with the previous analysis for the Approved Project implementation of **MM NOI-1** limiting construction activities would further ensure that no significant impacts would occur.

Operational Noise

The Modified Project site would generate noise during the operations phase of the Modified Project. Noise produced during the operations phase would include traffic-related noise from worker trips and stationary sources of noise from pumps, generators, valves, and associated machinery. In terms of traffic noise, an existing employee would visit the Modified Project site to monitor and maintain the facilities and would generate nominal new vehicle trips related to these activities. As such, the Modified Project would not generate an increase in traffic-related noise beyond what already is present. For stationary sources of noise, the groundwater extraction pump associated with the wastewater line would be the primary sources of long-term noise due to the constant use of the water treatment facility. Pumps, generators, and associated equipment would be located within enclosed structures, and therefore would not create a significant noise source as further detailed below. (AECOM 2021).

The pump motor for the Modified Project Site is rated at 250 horsepower (HP) and will be upgraded to 350 HP. According to the manufacturer data, the upgraded motor is anticipated to have noise emission levels similar to the existing motor. Additionally, the pump is proposed to be contained within an enclosed structure which would further attenuate noise levels. The Modified Project would not exceed noise standards during normal operation, and a less than significant impact would occur. Although no mitigation is required, consistent with the previous analysis for the Approved Project implementation of **MMs NOI-2** and **NOI-3** requiring a post-construction noise survey and restricting noise-generating well maintenance activities to during daytime hours would further ensure that no significant impacts would occur.

b) Generation of excessive groundborne vibration or ground borne noise levels?

No Substantial Change from Previous Analysis. As is typical of most cities and counties in California, there are no applicable City standards for vibration-induced annoyance or structural damage from vibration. The California Department of Transportation (Caltrans) has adopted vibration damage thresholds, which are shown in Table 4-7, to assess the potential for structural damage from vibration. The structural damage threshold for “older residential structures” of 0.3 ppv in/sec for continuous/frequent (i.e., intermittent) sources is most applicable to this analysis. For commercial and industrial buildings proximate to the Modified Project site, 0.5 ppv is applicable to this analysis.

**TABLE 4-7
VIBRATION DAMAGE THRESHOLD CRITERIA**

Structure and Condition	Maximum ppv (in/sec)	
	Transient Sources	Continuous/Frequent Intermittent Sources
Extremely fragile historic buildings, ruins, ancient monuments	0.12	0.08
Fragile buildings	0.2	0.1
Historic and some old buildings	0.5	0.25
Older residential structures	0.5	0.3
New residential structures	1.0	0.5
Modern industrial/commercial buildings	2.0	0.5

ppv: peak particle velocity; in/sec: inch(es) per second

Note: Transient sources create a single isolated vibration event, such as blasting or drop balls. Continuous/frequent intermittent sources include impact pile drivers, pogo-stick compactors, crack-and-seat equipment, vibratory pile drivers, and vibratory compaction equipment.

Source: Caltrans 2013.

The Caltrans vibration annoyance thresholds are shown in Table 4-8. These thresholds are used to assess the potential for a significant vibration impact for human annoyance; and annoyance is evaluated within occupied buildings. The vibration annoyance response of “distinctly perceptible” of 0.24 ppv is most applicable to this analysis.

**TABLE 4-8
VIBRATION ANNOYANCE THRESHOLDS**

Average Human Response	PPV inches per second
Severe	2.0
Strongly perceptible	0.9
Distinctly perceptible	0.24
Barely perceptible	0.035

ppv: peak particle velocity; in/sec: inch(es) per second

Source: Caltrans 2013.

Site development, earth removal, and repaving would occur at the Modified Project site. These construction activities would generate vibration. These activities involve the use of typical off-road vehicles and stationary equipment. Pile driving and blasting are generally the sources of the most severe vibration during construction. Neither pile driving nor blasting would be used during Project construction. Table 4-9 summarizes typical vibration levels associated with construction activities

for various vibration-inducing pieces of equipment, not all of which would be required for the Project.

**TABLE 4-9
VIBRATION LEVELS FOR
CONSTRUCTION EQUIPMENT**

Equipment		ppv at 25 ft (in/sec)
Pile driver (impact)	upper range	1.518
	typical	0.644
Pile driver (sonic)	upper range	0.734
	typical	0.170
Vibratory roller		0.210
Large bulldozer		0.089
Caisson drilling		0.089
Loaded trucks		0.076
Jackhammer		0.035
Small bulldozer		0.003
ppv: peak particle velocity; ft: feet; in/sec: inches per second. Source: Caltrans 2013; FTA 2006.		

Table 4-10 summarizes the anticipated vibration levels (measured in ppv) at the Modified Project site. It should be noted that, although it is not anticipated that the Project would use small or large bulldozers, the equipment is included to represent vibration from similar vibration-generating equipment such as a crane or an excavator. Vibration levels are based at the nearest land use and structure to each of the construction areas.

**TABLE 4-10
ESTIMATED VIBRATION LEVELS AT NEAREST RECEPTORS**

Construction Phase	Vibration Level (ppv)	Vibration Threshold (Building Damage/Annoyance ppv)	Exceeds
North Residence Assessed at 125 feet from Building			
Vibratory roller	0.019	0.3/0.24	No
Large bulldozer	0.008		
Small bulldozer	0.000		
Jackhammer	0.003		
Loaded trucks	0.007		
West Residences Assessed at 30 feet from Building			
Vibratory roller	0.160	0.3/0.24	No
Large bulldozer	0.068		
Small bulldozer	0.002		
Jackhammer	0.027		
Loaded trucks	0.058		
South Residences Assessed at 25 feet from Building			
Vibratory roller	0.210	0.3/0.24	No
Large bulldozer	0.089		
Small bulldozer	0.003		
Jackhammer	0.035		
Loaded trucks	0.076		
East Residences Assessed at 80 feet from Building			
Vibratory roller	0.037	0.3/0.24	No
Large bulldozer	0.016		
Small bulldozer	0.001		
Jackhammer	0.006		
Loaded trucks	0.013		
ppv: peak particle velocity			
Vibration calculations can be found in Attachment B.			

As shown in Table 4-9, vibration levels would not exceed the building damage and annoyance thresholds when construction activities occur closest to the nearest offsite building at the Modified Project site. Buildings located further from these analyzed locations would be exposed to lower levels of Project-related vibration. There would be a less than significant impact, and no mitigation is required.

- c) For a project located within the vicinity of a private airstrip or an airport land use plan or, where such a plan has not been adopted, within two miles of a public airport or public use airport, would the project expose people residing or working in the project area to excessive noise levels?**

No Substantial Change from Previous Analysis. Consistent with the finding of the IS/MND for the Approved Project, the Modified Project site is located to the North of John Wayne Airport, which is located approximately 8.3 miles away. Since the Modified Project site are not in the vicinity of an airstrip or airport land use, the Modified Project site will not be impacted by aircraft noise. No new or increased impact would occur; no mitigation is required; and no subsequent analysis is needed.

Conclusion

The impacts of the Modified Project would be consistent with the impacts identified for the previously Approved Project analyzed in the IS/MND. The Modified Project would not create a new significant impact or a substantial increase in the severity of previously identified effects. In regard to Section 15162 of the State CEQA Guidelines, the Modified Project (1) would not propose substantial changes; (2) would not have circumstantial changes when the Project is undertaken; (3) would bring about no new information of substantial importance that would (a) create new significant impacts, (b) increase the severity of previously examined effects, or (c) determine that mitigation measures or alternatives previously found not to be feasible would, in fact, be feasible; or (4) introduce mitigation measures that are considerably different from those analyzed in the previous documents. For these reasons, no major revisions to the noise analysis provided in the IS/MND are required.

Mitigation Program

The following mitigation measures were identified in the Previously Approved IS/MND and is applicable to the Modified Project. The Approved IS/MND's mitigation program includes measures to reduce potential noise impacts associated with the previously approved projects to less than significant levels. The following measures from the approved IS/MND would also be applicable to the Modified Project. Any modifications to the original measures are shown in strikethrough for non-applicable and/or deleted text and new inserted text is underlined.

NOI-1 To reduce noise generated by the proposed project, IRWD and the contractor will implement the following measures:

- All mobile or fixed noise-producing equipment used on the Project that is regulated for noise output by a local, State, or federal agency will comply with such regulation while in the course of Project activity.
- ~~The Contractor shall install noise attenuating panels including a 24-foot-tall noise wall and additional sound blankets to fully enclose the drill rig during drilling operations.~~
- ~~The Contractor shall use a drilling rig that is equipped with a muffler system such that the drilling rig generates reduced noise levels.~~
- ~~Noise levels shall be monitored periodically during 24-hour well drilling or testing. If noise levels at surrounding residential property lines exceeds nighttime noise standards (between the hours of 8:00pm to 7:00am), IRWD shall provide on a case-by-case basis, affected residents options to reduce or avoid elevated noise levels. Options may include, but are not be limited to, temporarily relocating affected residents to reasonably priced local hotels during periods of nighttime work.~~
- Electrically powered equipment instead of pneumatic or internal combustion powered equipment will be used, where feasible.
- Material stockpiles and mobile equipment staging, parking, and maintenance areas will be located as far as practicable from noise-sensitive receptors.
- Construction site speed limits will be established and enforced during the construction period.

- ~~For all construction other than well drilling, well development and pump testing associated with IRWD Well OPA-1, including noisy maintenance activities and all spoils and material transport, will be performed during daytime hours specified in the noise ordinance unless otherwise approved by the City of Orange.~~
- All construction associated with the Modified Project, including noisy maintenance activities and all spoils and material transport, will be performed during daytime hours specified in the noise ordinance unless otherwise approved by the City of Orange.
- The use of noise-producing signals, including horns, whistles, alarms, and bells will be for safety warning purposes only.
- No Project-related public address or music system will be used during nighttime hours.
- The onsite construction supervisor will have the responsibility and authority to receive and resolve noise complaints. A clear appeal process will be established prior to construction commencement that will allow for resolution of noise problems that cannot be immediately solved by the site supervisor.
- Construction signs will be posted at the Project site identifying a contact name and phone number to register noise complaints.

NOI-2 Once the proposed Project is operational, IRWD shall conduct a post-construction noise survey to ensure that operation of the well equipment is within the City of Orange's Noise Ordinance at the Project boundary and will be available to the City of Orange upon request.

NOI-3 Noise generating well maintenance activities shall be restricted to daytime hours (exempt from the City of Orange Noise Ordinance), unless otherwise approved by the City of Orange.

4.14 POPULATION AND HOUSING

4.14.1 SUMMARY OF PREVIOUS ENVIRONMENTAL REVIEW

Orange Park Acres Well Replacement Project Initial Study/Mitigated Negative Declaration

The IS/MND concluded the Approved Project site would not include new homes or businesses and thus the Approved Project development would not displace housing or residents. The Approved Project would include the construction and operation of one replacement groundwater well, intended to improve the domestic water service provided to existing residents within the OPA service area. The Approved Project would not directly induce population growth because it would serve as a replacement to the deteriorating Well OPA-3 which is proposed to be abandoned and demolished as part of the Approved Project. The Approved Project would increase production between 100 to 200 AFY, however, this increased production would only make up for the deteriorated Well OPA-3 pumping conditions and therefore the replacement Well OPA-1 would still pump at a maximum operational capacity of approximately 900 AFY. Since the Approved Project is intended to service the existing OPA residents and would not result in substantial population growth in the area, impacts would be less than significant.

4.14.2 PROJECT ENVIRONMENTAL REVIEW

Would the Project:

a) *Induce substantial unplanned population growth in an area, either directly (for example, by proposing new homes and businesses) or indirectly (for example, through extension of roads or other infrastructure)?*

No Substantial Change from Previous Analysis. Consistent with the previous analysis for the Approved Project, the Modified Project would not include new homes or businesses. The Modified Project would enable the resumption and increased domestic water capacity of groundwater conveyance from Well OPA-3 to meet IRWD's current and anticipated demands. However, the Modified Project would not extend water service into an area that is not currently developed or approved for future development. The Project would not result in either direct or indirect unplanned population growth. Additionally, the Project would not displace existing housing or population, resulting in construction of replacement housing elsewhere. No new impacts would occur.

b) *Displace substantial numbers of existing people or housing, necessitating the construction of replacement housing elsewhere?*

No Substantial Change from Previous Analysis. The Modified Project site is currently developed with a vacant residential unit that is owned by IRWD. The unit is not currently occupied; therefore, no residents would be displaced, and no construction of replacement housing would be required. No new impact would occur.

Conclusion

The impacts of the Modified Project would be consistent with the impacts identified for the previously Approved Project analyzed in the IS/MND. The Modified Project would not create a new significant impact or a substantial increase in the severity of previously identified effects. In regard to Section 15162 of the State CEQA Guidelines, the Modified Project (1) would not propose substantial changes; (2) would not have circumstantial changes when the Project is undertaken; (3) would bring about no new information of substantial importance that would (a) create new

significant impacts, (b) increase the severity of previously examined effects, or (c) determine that mitigation measures or alternatives previously found not to be feasible would, in fact, be feasible; or (4) introduce mitigation measures that are considerably different from those analyzed in the previous documents. For these reasons, no major revisions to the population and housing analysis provided in the IS/MND are required.

Mitigation Program

No mitigation was for population and housing impacts was required in the IS/MND.

4.15 PUBLIC SERVICES

4.15.1 SUMMARY OF PREVIOUS ENVIRONMENTAL REVIEW

Orange Park Acres Well Replacement Project Initial Study/Mitigated Negative Declaration

The IS/MND concluded that Approved Project development would not include addition of new housing or business and thus the Approved Project would not result in direct or indirect population growth population or housing. Therefore, the IS/MND concluded there would be no new demand for public services such as police protection, schools, parks, or other public facilities and no impacts would occur.

The abandonment of one existing well and construction and operation of a replacement well within the boundaries of an existing IRWD property would not change City of Orange Fire Department response times or substantially affect demand for fire protection services at the facility. Under the Approved Project, fire services potentially would be needed in the unlikely event of a chemical spill related to the disinfection system. However, the low risk of a chemical spill from the proposed system is similar to the existing low risk from the existing disinfection system on site for the current well. Therefore, there would be a negligible change in the demand for fire or emergency services for the Approved Project. The IS/MND concluded construction and operation of the Approved Project would not result in substantial adverse physical impacts associated with the provision of new or physically altered fire protection facilities, and impacts would be less than significant.

4.15.2 PROJECT ENVIRONMENTAL REVIEW

- a) ***Would the Project result in substantial adverse physical impacts associated with the provision of or need for new or physically altered governmental facilities, the construction of which could cause significant environmental impacts, in order to maintain acceptable service ratios, response times or other performance objectives for any of the public services: fire protection, police protection, schools, parks, and other public facilities?***

Fire Protection?

No Substantial Change from Previous Analysis. As discussed in Section 4.14, Population and Housing, the Modified Project would not result in direct or indirect population growth. Consistent with the previous analysis for the Approved Project, fire services potentially would be needed in the unlikely event of a chemical spill related to the disinfection system for Well OPA-1. Additionally, the Modified Project site is expanding onto the adjacent IRWD property at 660 North Gravier for the new water treatment system. However, fire services would have a negligible increase because the Modified Project is the resumption of the operation of Well OPA-1 and the property at 660 North Gravier is currently is a single-story residence owned by IRWD and currently serviced by the City of Orange Fire Department. Therefore, impacts would be less than significant for fire protection, and no new mitigation is required.

Police Protection, Schools, Parks, and Other Public Facilities?

No Substantial Change from Previous Analysis. As discussed in Section 4.14, Population and Housing, the Modified Project would not result in direct or indirect population growth. Consistent with the previous analysis for the Approved Project, the Modified Project would be a utility project and would not generate new demand for public services such as fire protection, police protection, schools, parks, libraries, or other public facilities. There would be no impact, and no mitigation is required.

Conclusion

The impacts of the Modified Project would be consistent with the impacts identified for the previously Approved Project analyzed in the IS/MND. The Modified Project would not create a new significant impact and it would not create a substantial increase in the severity of previously identified effects. In regard to Section 15162 of the State CEQA Guidelines, the Modified Project (1) would not propose substantial changes; (2) would not have circumstantial changes when the Project is undertaken; (3) would bring about no new information of substantial importance that would (a) create new significant impacts, (b) increase the severity of previously examined effects, or (c) determine that mitigation measures or alternatives previously found not to be feasible would, in fact, be feasible; or (4) introduce mitigation measures that are considerably different from those analyzed in the previous documents. For these reasons, no major revisions to the public services analysis provided in the IS/MND are required.

Mitigation Program

No mitigation for public services impacts was required in the IS/MND.

4.16 RECREATION

4.16.1 SUMMARY OF PREVIOUS ENVIRONMENTAL REVIEW

Orange Park Acres Well Replacement Project Initial Study/Mitigated Negative Declaration

The IS/MND determined that the Approved Project would not directly induce population growth; therefore, it would not increase use of any local recreational facilities. Impacts related to demand or use of existing neighborhood and regional parks or other recreational facilities or require construction or expansion of recreational facilities. No impacts to recreational facilities occurred.

4.16.2 PROJECT ENVIRONMENTAL REVIEW

a) *Would the project increase the use of existing neighborhood and regional parks or other recreational facilities such that substantial physical deterioration of the facility would occur or be accelerated?*

No Substantial Change from Previous Analysis. Consistent with the previous analysis for the Approved Project, the Modified Project would not directly induce population growth in the City Orange and thus would not generate increased demands for neighborhood or regional parks such that physical deterioration would occur or be accelerated. No new impact would occur.

b) *Does the project include recreational facilities or require the construction or expansion of recreational facilities which might have an adverse physical effect on the environment?*

No Substantial Change from Previous Analysis. Consistent with the previous analysis for the Approved Project, the Modified Project would not directly induce population growth in the City Orange and thus would not generate demands for new or expanded neighborhood or regional parks or increase the use of existing parks such that new or expanded facilities would be required. No new impact would occur.

Conclusion

The impacts of the Modified Project would be consistent with the impacts identified for the previously Approved Project analyzed in the IS/MND. The Modified Project would not create a new significant impact or a substantial increase in the severity of previously identified effects. In regard to Section 15162 of the State CEQA Guidelines, the Modified Project (1) would not propose substantial changes; (2) would not have circumstantial changes when the Project is undertaken; (3) would bring about no new information of substantial importance that would (a) create new significant impacts, (b) increase the severity of previously examined effects, or (c) determine that mitigation measures or alternatives previously found not to be feasible would, in fact, be feasible; or (4) introduce mitigation measures that are considerably different from those analyzed in the previous documents. For these reasons, no major revisions to the recreation analysis provided in the IS/MND are required.

Mitigation Program

No Mitigation for recreation impacts was required for the IS/MND.

4.17 TRANSPORTATION

4.17.1 SUMMARY OF PREVIOUS ENVIRONMENTAL REVIEW

Orange Park Acres Well Replacement Project Initial Study/Mitigated Negative Declaration

The IS/MND concluded that although the Approved Project is located entirely within an existing IRWD property, there is a potential for project-related traffic to affect adjacent roadways providing access to the Approved Project site during construction and operation. The Approved Project would implement project technical specifications, identified in **MM TR-1**, including construction signing; vehicular traffic control; pedestrian traffic control and safety; access to adjacent properties; and permanent traffic control devices. IRWD would obtain a City of Orange encroachment permit for any work within the City of Orange right of way. Furthermore, the Approved Project would conform to all applicable City of Orange ordinances, regulations, and traffic control guidelines for construction and operation.

During construction, the IS/MND determined no road or lane closures are expected; access to the Approved Project site would be provided via North Gravier Street; and the trips generated during construction would not result in a substantial decline in the existing levels of service at the intersections within proximity of the Approved Project site. Finally, construction would be temporary, and the slight increase in localized traffic associated with construction would be reduced once construction was complete. During operation, substantial increases in traffic volumes are not expected to result from the operation of IRWD Well OPA-1; thus, operational traffic volume impacts would be less than significant.

The IS/MND determined that the Approved Project would not involve modifications to the local circulation system and thus would not cause hazards due to a design feature. The IS/MND determined that Approved Project construction and operation would not cause inadequate emergency access to the Approved Project site or surrounding areas. With Implementation of **MM TR-1**, transportation and traffic impacts would be less than significant.

4.17.2 PROJECT ENVIRONMENTAL REVIEW

Would the Project:

- a) *Conflict with a program plan, ordinance or policy addressing the circulation system, including transit, roadway, bicycle and pedestrian facilities?***

No Substantial Change from Previous Analysis. Consistent with the previous analysis for the Approved Project, the Modified Project would be located on IRWD-owned property. During construction, project-related traffic would be temporary and would minimally affect adjacent roadways providing access to the Modified Project site. The Modified Project would conform to City of Orange ordinances and regulations including Title 10, Vehicles and Traffic; Title 17.34, Off-Street Parking and Loading; and Title 12.64, Encroachments in the Public Rights-of-Way. Compliance with City of Orange ordinances/regulations and implementation of **MM TR-1**, which requires a traffic control/traffic management plan subject to approval by the City prior to construction, would ensure the impact of construction-generated traffic would be less than significant. Further, the Modified Project would not add additional employees or vehicle trips for operation and maintenance. As with the Approved Project, operation would not affect access for the surrounding area. The traffic distribution pattern for the Modified Project would be identical to the traffic distribution pattern evaluated for the Approved Project. Therefore, the Modified Project would with implementation of **MM TR-1** and IRWD required procedures, and impacts would be

less than significant without mitigation. The Modified Project would also result in less than significant impacts, and no new impacts would occur.

b) Would the project conflict or be inconsistent with CEQA Guidelines section 15064.3, subdivision (b)?

No substantial change from previous analysis. Section 15064.3(b)(1) of the State CEQA Guidelines refers to evaluating transportation impacts using vehicle miles traveled (VMT) as a method of determining the significance of transportation impacts for land use projects. The proposed Project is not a land use project and would not generate any long-term change in traffic. As discussed in Response to Threshold 4.17.2. (a), the Modified Project's construction-related traffic would be temporary and operational traffic would be similar to the Approved Project. Therefore, implementation of the Modified Project would not conflict or be inconsistent with CEQA Guidelines section 15064.3 subdivision (b). Impacts would be less than significant, and no mitigation is required. VMT was not analyzed for the Approved Project in the IS/MND because implementation of Section 15064.3 became mandatory statewide effective July 1, 2020; therefore, a Project-specific VMT analysis was not prepared.

c) Substantially increase hazards due to a geometric design feature (e.g., sharp curves or dangerous intersections) or incompatible uses (e.g., farm equipment)?

No Substantial Change from Previous Analysis. Consistent with the previous analysis for the Approved Project, the Modified Project does not propose changes to surrounding roadways. The Modified Project would expand the existing driveway associated with the IRWD-owned single story structure located at 660 North Gravier Street to accommodate truck access for ion exchange resin changeouts and other various maintenance functions. The expanded driveway would be the same width as the existing driveway to the IRWD facility at 678 North Gravier Street and would be constructed per all City of Orange standards. Consistent with the Approved Project, all proposed intersections of driveways with roadways would be perpendicular; the designs of the intersections would not create hazards. Consistent with the Approved Project, Modified Project development would not add incompatible uses to area roadways. No new impact would occur, and no subsequent CEQA analysis is required.

d) Result in inadequate emergency access?

No Substantial Change from Previous Analysis. Modified Project development would not cause inadequate emergency access. Modified Project construction would not block public roadways and thus would not block emergency access to surrounding travel lanes. The impact of construction-generated traffic on emergency vehicle access would be minimized with compliance of City of Orange ordinances and regulations describe in Response to Threshold 4.17.2 (a) and implementation of **MM TR-1** which requires a traffic control/traffic management plan subject to approval by the City of Orange prior to construction. Additionally, the Modified Project site plan would provide emergency access to all reused and proposed new buildings conforming with *California Fire Code* Section 503. No new impact would occur.

Conclusion

The impacts of the Modified Project would be consistent with the impacts identified for the previously Approved Project analyzed in the IS/MND. The Modified Project would not create a new significant impact or a substantial increase in the severity of previously identified effects. In regard to Section 15162 of the State CEQA Guidelines, the Modified Project (1) would not propose substantial changes; (2) would not have circumstantial changes when the Project is undertaken; (3) would bring about no new information of substantial importance that would (a) create new

significant impacts, (b) increase the severity of previously examined effects, or (c) determine that mitigation measures or alternatives previously found not to be feasible would, in fact, be feasible; or (4) introduce mitigation measures that are considerably different from those analyzed in the previous documents. For these reasons, no major revisions to the transportation and traffic resources analysis provided in the IS/MND are required.

Mitigation Program

The following mitigation measure was identified in the Previously Approved IS/MND and is applicable to the Modified Project.

- TR-1** The construction contractors will prepare and implement a traffic control/traffic management plan subject to approval by the City of Orange prior to construction. The plan will accomplish the following:
- Identify the hours of construction for deliveries.
 - Include discussion of haul routes, work area delineation, traffic control, and flagging.
 - Identify all access and parking restrictions, pavement markings, and signage requirements (e.g., speed limit, temporary loading zone).
 - Maintain access to residences driveways and public facilities at all times.
 - Minimize access disruptions to residences.
 - Layout a plan for notifications and process for communication with affected residences and transit agencies prior to the start of construction. Advanced public notification will include providing written notification to adjacent residences at least 10 days prior to construction start and providing appropriate signage of construction activities. The written notification will include the construction schedule, exact location and duration of activities, and a toll-free telephone number for receiving questions and complaints.

4.18 TRIBAL CULTURAL RESOURCES

4.18.1 SUMMARY OF PREVIOUS ENVIRONMENTAL REVIEW

Orange Park Acres Well Replacement Project Initial Study/Mitigated Negative Declaration

Tribal Cultural impacts were not analyzed for the Approved Project because AB 52 applies to projects filed on or after July 1, 2015. The Project's IS/MND related to this Addendum was approved on April 23, 2012, by the IRWD Board of Directors. However, as discussed in Section V., Cultural Resources of the IS/MND, an SCCIC literature review and records search for the Project did not identify prehistoric archaeological resources within ¼ mile of the Approved Project site. Additionally, a Sacred Lands Files search conducted by the Native American Heritage Commission were negative for tribal cultural resources important to the Native American community. As discussed in the IS/MND, the City of Orange General Plan PEIR identifies the Approved Project site as being located in an area with a low sensitivity for prehistoric archaeological resources. Nevertheless, the absence of archaeological resources at the surface level does not preclude the existence of such resources. However, in the event any potential undocumented buried archaeological and/or tribal cultural resources be uncovered during construction, IRWD's standard operating procedures for contractors involve ceasing construction immediately within 50 feet of the discovery; contacting a qualified archaeologist to assess the significance of the find; and, if necessary, develop appropriate treatment measures with local tribal representatives before proceeding with construction. Impacts of the Modified Project would be less than significant, and no new impact would occur.

4.18.2 PROJECT ENVIRONMENTAL REVIEW

Would the Project cause a substantial adverse change in the significance of a tribal cultural resource, defined in Public Resources Code Section 21074 as either a site, feature, place, cultural landscape that is geographically defined in terms of the size and scope of the landscape, sacred place, or object with cultural value to a California Native American tribe, and that is:

- a) Listed or eligible for listing in the California Register of Historical Resources, or in a local register of historical resources as defined in Public Resources Code Section 5020.1(k)?***

No Impact. For purposes of impact analysis, a tribal cultural resource is considered a site, feature, place, cultural landscape, sacred place, or object which is of cultural value to a California Native American Tribe and is eligible for the CRHR or a local register. As indicated in Section 4.5.2. (a) of this Addendum, based on City of Orange General Plan PEIR (Orange 2010) and the NRHP, the CRHR, California Historical Landmarks, and California Points of Historical Interest, there are no known listed properties eligible within 0.25-mile radius of the Modified Project site (NPS 2021, OHP 2021a, OHP 2021b).

Because the document would be an Addendum to a previously approved CEQA document, the Project would not be subject to the Native American Consultation requirements pursuant to AB 52. Therefore, the proposed Project would not have an impact on tribal cultural resources associated with an impact to a resource that is listed or eligible for listing on the CRHR or a local register. No mitigation is required.

- b) A resource determined by the lead agency, in its discretion and supported by substantial evidence, to be significant pursuant to criteria set forth in subdivision (c) of Public Resources Code Section 5024.1. In applying the criteria set forth in***

subdivision (c) of Public Resources Code Section 5024.1, the lead agency shall consider the significance of the resource to a California Native

No Impact. The second component of this threshold is if the proposed Project would impact “A resource determined by the lead agency, in its discretion and supported by substantial evidence, to be significant pursuant to criteria set forth in subdivision (c) of Public Resource Code Section 5024.1, the lead agency shall consider the significance of the resource to a California Native American tribe.” Subdivision (c) states:

A resource may be listed as an historical resource in the California Register if it meets any of the following CRHR criteria:

- (1) Is associated with events that have made a significant contribution to the broad patterns of California’s history and cultural heritage.
- (2) Is associated with the lives of persons important in our past.
- (3) Embodies the distinctive characteristics of a type, period, region, or method of construction, or represents the work of an important creative individual, or possesses high artistic values.
- (4) Has yielded, or may be likely to yield, information important in prehistory or history.

As noted above, a Sacred Lands Files search conducted by the Native American Heritage Commission was negative for tribal cultural resources important to the Native American community. As discussed in the IS/MND, the City of Orange General Plan PEIR identifies the Approved Project site as being located in an area with a low sensitivity for prehistoric archaeological resources. Nevertheless, the absence of archaeological resources at the surface level does not preclude the existence of such resources. However, in the event any potential undocumented buried archaeological and/or tribal cultural resources be uncovered during construction, IRWD’s standard operating procedures for contractors involve ceasing construction immediately within 50 feet of the discovery; contacting a qualified archaeologist to assess the significance of the find; and, if necessary, develop appropriate treatment measures with local tribal representatives before proceeding with construction.

Because the document would be an Addendum to a previously approved CEQA document, the Project would not be subject to the Native American Consultation requirements pursuant to AB 52. No new impact would occur.

MITIGATION PROGRAM

No mitigation for tribal cultural resources was required in the IS/MND.

4.19 UTILITIES AND SERVICE SYSTEMS

4.19.1 SUMMARY OF PREVIOUS ENVIRONMENTAL REVIEW

Orange Park Acres Well Replacement Project Initial Study/Mitigated Negative Declaration

Water

The IS/MND determined the Approved Project would not include the construction of new homes or businesses and would not induce population growth. The Approved Project is the replacement of existing groundwater infrastructure to continue serving the existing IRWD service area. Because the Project itself involves the construction of new or expanded water treatment facilities, the IS/MND restated the significant impacts identified throughout the document associated with development and operation of the Approved Project. As noted in the IS/MND, all impacts evaluated throughout the IS/MND were identified as less than significant with mitigation incorporated, including **BIO-1, GEO-1, NOI-1, 2, and 3, and TR-1.**

Wastewater

The IS/MND identified sewer service for the Approved Project would be provided by the City of Orange's Public Works Department who is responsible for conveying wastewater to the Orange County Sanitation District (OC San 2020). The IS/MND concluded the existing sewers serving the site have sufficient capacity for construction and Project-generated wastewater. Impacts were determined to be less than significant with mitigation incorporated

Storm Drainage

The IS/MND concluded that existing storm drainage facilities serving the site would accommodate site runoff in post-Project conditions, and no new or expanded drainage facilities were required. Impacts were determined to be less than significant.

Solid Waste

The IS/MND determined that Project construction activities would generate solid waste in the form of demolition debris from the destruction of Well OPA-3 and demolition of the disinfection system and building. Well OPA-3 pump and associated components would be delivered to IRWD's Michelson Water Reclamation Plant for cleaning and reuse in another IRWD facility following all appropriate protocols, procedures, and regulations. Frank R. Bowerman Landfill in Irvine, the Olinda Alpha Landfill in Brea, and the Prima Deshecha Landfill in San Juan Capistrano would handle solid waste from demolition debris. In total, these facilities have sufficient capacity for Project-generated solid waste and that the Project would comply with regulations governing solid waste disposal. Impacts were identified as less than significant.

4.19.2 PROJECT ENVIRONMENTAL REVIEW

Would the Project:

- a) **Require or result in the relocation or construction of new or expanded water, or wastewater treatment or storm water drainage, electric power, natural gas, or telecommunications facilities, the construction or relocation of which could cause significant environmental effects?**

No Substantial Change from Previous Analysis.

Water

Consistent with the previous analysis for the Approved Project, the Modified Project would not include the construction of new homes or businesses and would not induce population growth. The Modified Project is the addition of a water treatment system in order to resume the use of Well OPA-1 for the IRWD service areas. Because the Project itself involves the construction of new or expanded water treatment facilities, consistent with the approach taken presented in the IS/MND, the Modified Project would result in potentially significant impacts as identified throughout this Addendum, related to biology, geology and soils, and traffic. Consistent with the Approved Project, all impacts are evaluated as part of this Addendum (detailed in Sections 4.4, Biological Resources; 4.7, Geology and Soils; and 4.17, Transportation) were identified as less than significant with mitigation incorporated, including **MMs BIO-1, GEO-1, NOI-1, NOI-2, NOI-3, and TR-1**. Therefore, all potentially significant impacts related to implementation of the Modified Project would be less than significant with mitigation incorporated.

Wastewater

As described above in Response to Threshold 4.20.1. (a) Water, the Modified Project would not include the construction of new homes or businesses and would not induce population growth. Consistent with the previous analysis for the Approved Project, the Modified Project is the continued operation of groundwater for existing IRWD service areas. IRWD employees would visit the site for routine operation and maintenance. Further, the Modified Project proposes landscaping on about the same proportion of the Project site as the Approved Project. Wastewater service in the Project vicinity is provided by the City of Orange's Public Works Department. The City of Orange's Public Works Department is responsible for installation and maintenance of local wastewater collection facilities, which convey wastewater to Orange County Sanitation District (OC San 2020) trunk sewers. Thus, wastewater use for the Modified Project is expected to be approximately the same as for the Approved Project. Impacts would be less than significant, and no new impact would occur.

Storm Water Drainage

The Modified Project would increase the amount of impervious surfaces on the Modified Project site compared to existing conditions; however, the additional impervious surfaces would be minimal because of the existing footprint of the structure. Consistent with the previous analysis for the Approved Project, the Modified Project would implement BMPs and comply will applicate State, regional, and local regulations and procedures. BMPs include preparation and implementation of an erosion control plan and a Spill Prevention Plan. Similar to the Approved Project, the Modified Project would limit discharges of runoff off site to no more than the existing runoff rate, pursuant to OCFCD and the City of Orange Municipal Code requirements. The Modified Project would obtain a flood control encroachment permit would be required to discharge into the existing stormwater drain and would stipulate any relevant discharge conditions. Modified

Project development would not require construction of additional or expanded storm water drainage facilities compared to existing conditions. Impacts would be less than significant, and no new impact would occur.

Electricity

The Modified Project comprises more infrastructure than existing conditions, primarily through components to the existing facility for the water treatment of Well OPA-1. Although electricity demand was not quantified in the IS/MND prepared for the Approved Project, the Modified Project is expected to generate slightly increased electricity demands than existing conditions, and electricity would be provided pursuant to Public Utilities Commission regulations and requirements. Further, as discussed previously in Section 4.11 Land Use, the Modified Project site land uses would be similar to the Approved Project per the City Orange's General Plan PEIR (Orange 2010). Therefore, impacts would be less than significant, and no new impacts would occur.

Natural Gas

Although natural gas demand was not quantified in the IS/MND, the existing IRWD facility does not use natural gas. However, natural gas was used by the single-story structure at 660 North Gravier Street when operated as a residence. The structure is currently unoccupied and will be demolished under the Modified Project. Natural gas service would be removed pursuant to Public Utilities Commission and local regulations and requirements.

Consistent with the Approved Project, the Modified Project would not require natural gas (AECOM 2021). Further, as discussed previously in Section 4.11 Land Use, the Modified Project site land uses would be similar to the Approved Project per the City of Orange's General Plan PEIR (Orange 2010). Therefore, impacts would be less than significant, and no new impacts would occur.

Telecommunications

Consistent with the previous analysis for the Approved Project, IRWD employees would visit the site for routine operation and maintenance only for the Modified Project development and the use of telecommunications for the Modified Project would be minimal. Although telecommunications was not expressly evaluated in the IS/MND prepared for the Approved Project, telecommunications service would be provided pursuant to Public Utilities Commission regulations and requirements. Further, as discussed previously in Section 4.11 Land Use, the Modified Project site land uses would be similar to the Approved Project per the City of Orange's General Plan PEIR (Orange 2010). Therefore, impacts would be less than significant, and no new impacts would occur.

b) Have sufficient water supplies available to serve the project and reasonably foreseeable future development during normal, dry and multiple dry years?

No Substantial Change from Previous Analysis. Consistent with the previous analysis for the Approved Project, the Modified Project is to ensure the continual use of groundwater for the IRWD service areas. Although water supply availability to serve the Approved Project and reasonably foreseeable future development during normal, dry and multiple dry years was not expressly evaluated in the IS/MND, water supply would be provided pursuant to State, regional, and local regulations and requirements. The Modified Project would consume minimal water for the operation and maintenance of the facility and would contribute to local water supplies in normal, single-dry, and multiple-dry years. No impact would occur.

- c) Result in a determination by the wastewater treatment provider which serves or may serve the Project that it has adequate capacity to serve the Project's projected demand in addition to the provider's existing commitments?**

No Substantial Change from Previous Analysis. No new impact to wastewater treatment capacity would occur, as explained above in Section 4.19.2(a)

- d) Generate solid waste in excess of State or local standards, or in excess of the capacity of local infrastructure, or otherwise impair the attainment of solid waste reduction goals?**

No Substantial Change from Previous Analysis. The Modified Project involves an increased footprint and increased infrastructure components than the Approved Project and therefore is expected to generate more solid waste than the Approved Project. The Modified Project construction activities would generate solid waste in the form of demolition debris from the destruction of existing single-story residence at 660 North Gravier. The existing facility at 678 North Gravier would undergo site improvements, primarily for the addition of components for the water treatment facility and the construction of a new driveway.

Consistent with the previous analysis for the Approved Project, any associated components not required for the Modified Project would be delivered to IRWD's Michelson Water Reclamation Plant for cleaning and reuse in another IRWD facility and would follow all appropriate protocols, procedures, and regulations. Solid waste from demolition debris and operations, would be handled by Frank R. Bowerman Landfill in Irvine, the Olinda Alpha Landfill in Brea, and the Prima Deshecha Landfill in San Juan Capistrano. These facilities have sufficient capacity to accept commercial Project-generated solid waste. The Modified Project would comply with all applicable regulations governing solid waste disposal. No new impact to solid waste disposal capacity or solid waste reduction goals would occur. Impacts would be less than significant; no new mitigation would be required.

- e) Comply with federal, State, and local statutes and regulations related to solid waste?**

No Substantial Change from Previous Analysis. Consistent with the previous analysis for the Approved Project, the Modified Project would comply with policies governing solid waste disposal and diversion, including the California Integrated Waste Management Act of 1989 (AB 939). Further, the Modified Project will comply with Section 5.408 of the 2019 CALGreen Code (*California Code of Regulations* Title 24 Part 11). No new impact would occur.

Conclusion

The impacts of the Modified Project would be consistent with the impacts identified for the previously Approved Project analyzed in the IS/MND. The Modified Project would not create a new significant impact or a substantial increase in the severity of previously identified effects. In regard to Section 15162 of the State CEQA Guidelines, the Modified Project (1) would not propose substantial changes; (2) would not have circumstantial changes when the Project is undertaken; (3) would bring about no new information of substantial importance that would (a) create new significant impacts, (b) increase the severity of previously examined effects, or (c) determine that mitigation measures or alternatives previously found not to be feasible would, in fact, be feasible; or (4) introduce mitigation measures that are considerably different from those analyzed in the previous documents. For these reasons, no major revisions to the utilities and services systems analysis provided in the IS/MND are required.

Mitigation Program

The following mitigation measure was identified in the Previously Approved IS/MND and is applicable to the Modified Project.

The following mitigation measures was identified in the Previously Approved IS/MND for utilities and service systems impacts. **BIO-1**, **GEO-1**, and **TR-1** is applicable to the Modified Project and would reduce impacts to less than significant levels. Although a significant noise impact was not identified, **NOI-1**, **NOI-2**, and **NOI-3** are applicable to the Modified Project and would ensure that a significant impact would not occur.

BIO-1 identified in Section 4.4, Biological Resources.

GEO-1 identified in Section 4.7, Geology and Soils.

NOI-1, **NOI-2**, and **NOI-3** identified in Section 4.13, Noise.

TR-1 identified in Section 4.17, Transportation.

4.20 WILDFIRE

Wildfire impacts of the Approved Project were partially analyzed in the Hazards and Hazardous Materials response of the IS/MND. Wildfire impacts were partially analyzed in the IS/MND because the topic of Wildfire was added to the CEQA Checklist Appendix G in the 2018 State CEQA Guidelines. The section below provides an analysis of Wildfire for the Modified Project.

4.20.1 SUMMARY OF PREVIOUS ENVIRONMENTAL REVIEW

Orange Park Acres Well Replacement Project Initial Study/Mitigated Negative Declaration

The IS/MND determined that the Project site was not in or near a Wildland Fire Hazard Areas according to the City of Orange General Plan Safety Element. Furthermore, the Approved Project would not construct housing units or increase population. Therefore, the IS/MND concluded the Approved Project would not expose people or structures to a significant risk of loss, injury, or death involving wildland fires, and no impact would occur.

4.20.2 PROJECT ENVIRONMENTAL REVIEW

If located in or near state responsibility areas or lands classified as very high fire hazard severity zones, would the project:

- a) ***Substantially impair an adopted emergency response plan or emergency evacuation plan?***
- b) ***Due to slope, prevailing winds, and other factors, exacerbate wildfire risks, and thereby expose project occupants to, pollutant concentrations from a wildfire or the uncontrolled spread of a wildfire?***
- c) ***Require the installation or maintenance of associated infrastructure (such as roads, fuel breaks, emergency water sources, power lines or other utilities) that may exacerbate fire risk or that may result in temporary or ongoing impacts to the environment?***
- d) ***Expose people or structures to significant risks, including downslope or downstream flooding or landslides, as a result of runoff, post-fire slope instability, or drainage changes?***

No Substantial Change from Previous Analysis. According to the Fire and Resource Assessment Program *Very High Fire Hazard Severity Zones in LRA As Recommended by CAL FIRE* map for the City of Orange. Therefore, the Modified Project as the Approved Project is not located within or near any areas designated a Very High Fire Hazard Severity Zones (VHFHSZ) or a State Responsibility Area. The nearest VHFHSZ-designated area is located approximately 3.0 miles to the east (CAL FIRE 2021). There would be no impacts related to wildfires, and no mitigation is required.

Conclusion

The impacts of the Modified Project would be consistent with the impacts identified for the previously Approved Project analyzed in the IS/MND. The Modified Project would not create a new significant impact or a substantial increase in the severity of previously identified effects. In regard to Section 15162 of the State CEQA Guidelines, the Modified Project (1) would not propose substantial changes; (2) would not have circumstantial changes when the Project is undertaken;

(3) would bring about no new information of substantial importance that would (a) create new significant impacts, (b) increase the severity of previously examined effects, or (c) determine that mitigation measures or alternatives previously found not to be feasible would, in fact, be feasible; or (4) introduce mitigation measures that are considerably different from those analyzed in the previous documents. For these reasons, no major revisions to the wildfire analysis provided in the IS/MND are required.

Mitigation Program

No mitigation for wildfire impacts was required in the IS/MND.

4.21 MANDATORY FINDINGS OF SIGNIFICANCE

4.21.1 SUMMARY OF PREVIOUS ENVIRONMENTAL REVIEW

Orange Park Acres Well Replacement Project Initial Study/Mitigated Negative Declaration

The IS/MND determined that the Approved Project would not have a substantial adverse effect on any sensitive habitat or adversely affect populations or communities of fish or wildlife. **MM BIO-1** is incorporated to comply with the Migratory Bird Treaty Act and to reduce impacts to nesting birds to less than significant. Further, no historical cultural resources would be affected by the construction or operation of the proposed project. Additionally, the IS/MND concluded the Approved Project would not result in cumulative impacts on the physical environment. The Approved Project would create a minimal increase in water supply within the OPA service area; however, due to its limited size and magnitude and OCWD's basin management programs, the Approved Project would have less than significant effects on groundwater elevations and gradients and other projects would not be cumulatively considerable.

Based on the analysis of the IS/MND, the Approved Project would have potentially significant environmental effects that could cause substantial adverse effects on human beings, either directly or indirectly. However, implementation of mitigation measures would reduce these impacts to a less-than-significant level. **MM GEO-1** would require a preconstruction geotechnical assessment to reduce potential risks of project construction and operation due to lateral spreading, liquefaction, and subsidence. With incorporation of **MMs NOI-1** through **NOI-3**, temporary and permanent impacts associated with operational noise impacts to neighboring sensitive receptors would be less than significant. Finally, incorporation of **MM TR-1** would include specifications regarding construction signing, vehicular traffic control, pedestrian traffic control and safety, access to adjacent properties, and permanent traffic control devices to reduce transportation impacts associated with construction. Therefore, the Approved Project would not cause substantial direct or indirect adverse effects to human beings, sensitive habitat, or wildlife and impacts would be less than significant with mitigation.

4.21.2 PROJECT ENVIRONMENTAL REVIEW

Does the Project:

- a) ***Have the potential to substantially degrade the quality of the environment, substantially reduce the habitat of a fish or wildlife species, cause a fish or wildlife population to drop below self-sustaining levels, threaten to eliminate a plant or animal community, substantially reduce the number or restrict the range of rare or endangered plant or animal, or eliminate important examples of the major periods of California history or prehistory?***

No Substantial Change from Previous Analysis. As described throughout the analysis in Section 4.0, with the incorporation of the identified mitigation measures, including the incorporation of **MM BIO-1** to comply with the MBTA and to reduce impacts to nesting birds to less than significant, implementation of the Modified Project would not degrade the quality of the environment; would not substantially reduce the habitats of fish or wildlife species; would not cause a fish or wildlife population to drop below self-sustaining levels; would not threaten to eliminate a plant or animal; and would not eliminate important examples of major periods of California history or prehistory regardless of which site option is selected. Consistent with the previous analysis for the Approved Project, with respect to the quality of the environment, the Modified Project would not preclude the ability to achieve long-term environmental goals.

b) Have impacts that are individually limited, but cumulatively considerable? ("Cumulatively considerable" means that the incremental effects of a project are considerable when viewed in connection with the effects of past projects, the effects of other current projects, and the effects of probable future projects)?

No Substantial Change from Previous Analysis. While the Modified Project may have the potential to impact the environment, feasible mitigation measures would be implemented to reduce these impacts to a less than significant level. Also, all identified mitigation measures are related to construction-period impacts. The likelihood of another construction project occurring at the same time in the immediate vicinity, which would be required to potentially result in a cumulative impact related to biological resources, cultural resources, geology and soils (paleontology only), hydrology and water quality, or tribal cultural resources, is remote and not reasonably foreseeable. Consistent with the previous analysis for the Approved Project, there would be less than significant cumulative impacts.

c) Have environmental effects which will cause substantial adverse effects on human beings, either directly or indirectly?

No Substantial Change from Previous Analysis. Based on the analysis of the above-listed topics, the Modified Project could have the potential to impact human beings, either directly or indirectly; however, the implementation of the mitigation measures described throughout this document would reduce all potential impacts to less than significant levels. **MM GEO-1**, requiring a preconstruction geotechnical assessment, would reduce potential risks due to lateral spreading, liquefaction, subsidence, unstable soils, or expansive soils to less than significant levels. **MM TR-1** would include specifications regarding construction signing, vehicular traffic control, pedestrian traffic control and safety, access to adjacent properties, and permanent traffic control devices to reduce transportation impacts associated with construction. Consistent with the previous analysis for the Approved Project, with implementation of identified mitigation measures, the Modified Project would not cause substantial adverse impacts on humans, either directly or indirectly.

Conclusion

The impacts of the Modified Project would be consistent with the impacts identified for the previously Approved Project analyzed in the IS/MND. The Modified Project would not create a new significant impact or a substantial increase in the severity of previously identified effects. In regard to Section 15162 of the State CEQA Guidelines, the Modified Project (1) would not propose substantial changes; (2) would not have circumstantial changes when the Project is undertaken; (3) would bring about no new information of substantial importance that would (a) create new significant impacts, (b) increase the severity of previously examined effects, or (c) determine that mitigation measures or alternatives previously found not to be feasible would, in fact, be feasible; or (4) introduce mitigation measures that are considerably different from those analyzed in the previous documents. For these reasons, no major revisions to the Mandatory Findings of Significance analysis provided in the IS/MND are required.

SECTION 5.0 CONCLUSIONS

Based on the analysis provided in this Addendum, the record demonstrates sufficient evidence to determine that (1) the Modified Project does not represent a substantial change from the previously Approved Project evaluated in *Orange Park Acres Well Replacement Project IS/MND* (SCH No. 2011061038); (2) no substantial changes have occurred with respect to the circumstances under which the Modified Project is undertaken; and (3) the modifications to the Modified Project have not introduced new information of substantial importance which was not known and could not have been known at the time the project was certified as complete. The Modified Project would not have any new or substantially more severe impacts than what was evaluated in *Orange Park Acres Well Replacement Project IS/MND* (SCH No. 2011061038). No new Mitigation Measures are recommended in addition to those adopted at the time the project was approved that would further reduce project impacts. *Orange Park Acres Well Replacement Project IS/MND* and this Addendum, provides adequate documentation pursuant to the CEQA for the Orange Park Acres Well Replacement Project.



Signature

Jo Ann Corey, MPA
Printed Name



Date

Environmental Compliance Analyst
Title

This page intentionally left blank

SECTION 6.0 REFERENCES

- AECOM. 2021 (May 25). OCWD Project No. IRWD-2021-1 IRWD Project PR 11720 IRWD OPA-1 Water Treatment Project Basis of Design Report – Final. Orange, CA: AECOM. Appendix E
- California Air Pollution Control Officers Association (CAPCOA). 2021 (July, last accessed). Download Model: CalEEMod Version 2020.4.0. Diamond Bar, CA: CAPCOA. <http://www.aqmd.gov/caleemod/inquiry>.
- California Department of Forestry and Fire Prevention (CAL FIRE). 2021 (June 15, access date). FHSZ Viewer. Sacramento, CA. CAL FIRE. <http://egis.fire.ca.gov/FHSZ/>.
- California Department of Transportation (Caltrans). 2018. California State Scenic Highway System Map. Sacramento, CA. Caltrans. <https://www.arcgis.com/apps/webappviewer/index.html?id=2e921695c43643b1aaf7000dfcc19983>
- . 2013 (September). Technical Noise Supplement to the Traffic Noise Analysis Protocol. Sacramento, CA: Caltrans. http://www.dot.ca.gov/hq/env/noise/pub/TeNS_Sept_2013B.pdf.
- California Geological Survey (CGS). 2021 (July 11, access date). Tsunami Hazard Area Map. Sacramento, CA: CGS. <https://maps.conservation.ca.gov/cgs/informationwarehouse/>
- California, State of. 2015 (January 2019). California Code of Regulations (Title 14, Natural Resources; Division 6, Resources Agency; Chapter 3, Guidelines for Implementation of the California Environmental Quality Act). Sacramento, CA: the State.
- Converse Consultants. 2021 (April 2). *Geotechnical Investigation Report OCWD PFAS Treatment Facility Orange Park Acres Well Replacement No. 1 Wellhead Facilities*. Monrovia, CA: Converse. Appendix C.
- Division of Land Resource Protection (DLRP). 2021 (June 10, access date). California Important Farmland Finder. Sacramento, CA. DLRP. <https://maps.conservation.ca.gov/dlrp/ciff/>.
- Environmental Data Resources, Inc. (EDR). 2021 (June 10). *The EDR Radius Map™ Report with GeoCheck®: Orange Park Acres Well Replacement Project (Inquiry Number 6531282.2s)*. Shelton, CT: EDR. Appendix B.
- ICF. 2012 (April 23). Irvine Ranch Water District *Orange Park Acres Well Replacement Project Initial Study and Mitigated Negative Declaration*. Irvine, CA: ICF.
- National Park Services. (NPS) 2021 (June 17). *National Register Database and Research*. Washington, DC: NPS. <https://www.nps.gov/subjects/nationalregister/database-research.htm>
- Office of Historic Preservation (OHP). 2021a (July 7). California Historical Landmarks. Sacramento, CA: OHP. https://ohp.parks.ca.gov/?page_id=21387
- . 2021b (July 7). California Points of Historical Interest. Sacramento, CA: OHP. https://ohp.parks.ca.gov/?page_id=21750

- Orange, City of. 2021a (July 11). *City of Orange Public Works Water Division*. City of Orange, CA: Orange. <https://www.cityoforange.org/492/Water-Division>
- . 2021b (July 9, last accessed) *Municipal Code*. Orange, CA: Orange, CA: https://library.municode.com/ca/orange/codes/municipal_code?nodeId=TIT8HESA_CH8.24NOCO
- . 2020 (September 1). *City of Orange Zoning Map*. City of Orange, CA: Orange. <https://www.cityoforange.org/287/Planning-Division>.
- . 2015a (December). *Orange General Plan Figure LU-5 Land Use Policy Map*. City of Orange, CA: Orange. <https://www.cityoforange.org/287/Planning-Division>.
- . 2015b (December). *Orange General Plan Land Use Element*. City of Orange, CA: Orange. <https://www.cityoforange.org/287/Planning-Division>.
- . 2010 (March). *Orange General Plan Program Environmental Impact Report*. City of Orange, CA: Orange. <https://www.cityoforange.org/287/Planning-Division>.
- Orange County Sanitation District (OC San). 2020 (July 1). *Adopted Budget Update, Fiscal Years 2021–2022*. County of Orange, CA: OC San. <https://www.ocsan.gov/about-us/transparency/financials/financial-information-and-forms/-folder-956>.
- Orange County Water District (OCWD). 2015 (June 17). *Ground Water Management Plan 2015 Update*. County of Orange, CA: OCWD. http://www.ocwd.com/media/3622/groundwatermanagementplan2015update_20150624.pdf.
- South Coast Air Quality Management District (SCAQMD). 2019. (April, revised). *SCAQMD Air Quality Significance Thresholds*. Diamond Bar, CA: SCAQMD. <http://www.aqmd.gov/docs/default-source/ceqa/handbook/scaqmd-air-quality-significance-thresholds.pdf>.
- . 2017 (March). *Final 2016 Air Quality Management Plan*. Diamond Bar, CA: SCAQMD. <https://www.aqmd.gov/docs/default-source/clean-air-plans/air-quality-management-plans/2016-air-quality-management-plan/final-2016-aqmp/final2016aqmp.pdf?sfvrsn=15>
- . 2009 (October 21). *Appendix C to Final Localized Significance Threshold Methodology*. Diamond Bar, CA: SCAQMD. <http://www.aqmd.gov/ceqa/handbook/LST/appC.pdf>.
- . 2003 (August). *White Paper on Potential Control Strategies to Address Cumulative Impacts from Air Pollution (Appendix A)*. Diamond Bar, CA: SCAQMD.
- . 1993. *CEQA Air Quality Handbook*. Diamond Bar, CA: SCAQMD.
- U.S. Department of Transportation, Federal Transit Administration (FTA). 2006 (May). *Transit Noise and Vibration Impact Assessment, FTA-VA-90-1003-06* (prepared by Harris Miller & Hanson, Inc.). Washington, D.C.: FTA. https://www.transit.dot.gov/Sites/fta.dot.gov/files/docs/FTA_Noise_and_Vibration_Manual.pdf.
- U.S. Fish and Wildlife Service (USFWS). 2021 (June 11, access date). *National Wetlands Mapper*. Washington, D.C. USFWS. <https://www.fws.gov/wetlands/data/mapper.html>.

U.S. Geological Survey (USGS). 2021. (June 14, access date). Areas of Land Subsidence in California. https://ca.water.usgs.gov/land_subsidence/california-subsidence-areas.html.

United States Environmental Protection Agency (USEPA). 1971 (December 31). Noise from Construction Equipment and Operations, Building Equipment, and Home Appliances. Washington, D.C.: USEPA.

This page intentionally

APPENDIX A
CALEEMOD CALCULATIONS

Orange Park Acres, IRWD - Orange County, Winter

EMFAC Off-Model Adjustment Factors for Gasoline Light Duty Vehicle to Account for the SAFE Vehicle Rule Not Applied

**Orange Park Acres, IRWD
Orange County, Winter**

1.0 Project Characteristics

1.1 Land Usage

Land Uses	Size	Metric	Lot Acreage	Floor Surface Area	Population
User Defined Industrial	1.00	User Defined Unit	0.38	16,610.00	0

1.2 Other Project Characteristics

Urbanization	Urban	Wind Speed (m/s)	2.2	Precipitation Freq (Days)	30
Climate Zone	8			Operational Year	2022
Utility Company	Southern California Edison				
CO2 Intensity (lb/MWhr)	390.98	CH4 Intensity (lb/MWhr)	0.033	N2O Intensity (lb/MWhr)	0.004

1.3 User Entered Comments & Non-Default Data

- Project Characteristics -
- Land Use - Estimated lot acreage
- Construction Phase - .
- Off-road Equipment - .
- Off-road Equipment - .
- Off-road Equipment - No building construction, minor modifications inside building and install of outdoor equipment.
- Off-road Equipment - .
- Grading - .
- Demolition - .
- Trips and VMT - .
- Energy Use - no natural gas required
- Construction Off-road Equipment Mitigation -

Orange Park Acres, IRWD - Orange County, Winter

EMFAC Off-Model Adjustment Factors for Gasoline Light Duty Vehicle to Account for the SAFE Vehicle Rule Not Applied

Table Name	Column Name	Default Value	New Value
tblConstructionPhase	NumDays	100.00	131.00
tblConstructionPhase	NumDays	10.00	12.00
tblConstructionPhase	NumDays	2.00	26.00
tblConstructionPhase	NumDays	5.00	12.00
tblConstructionPhase	NumDaysWeek	5.00	6.00
tblConstructionPhase	NumDaysWeek	5.00	6.00
tblConstructionPhase	NumDaysWeek	5.00	6.00
tblConstructionPhase	NumDaysWeek	5.00	6.00
tblConstructionPhase	PhaseEndDate	6/22/2022	8/2/2022
tblConstructionPhase	PhaseEndDate	1/28/2022	1/29/2022
tblConstructionPhase	PhaseEndDate	2/2/2022	3/2/2022
tblConstructionPhase	PhaseEndDate	6/29/2022	8/16/2022
tblConstructionPhase	PhaseStartDate	2/3/2022	3/3/2022
tblConstructionPhase	PhaseStartDate	6/23/2022	8/3/2022
tblEnergyUse	NT24E	0.00	202.72
tblGrading	MaterialExported	0.00	160.00
tblLandUse	LandUseSquareFeet	0.00	16,610.00
tblLandUse	LotAcreage	0.00	0.38
tblOffRoadEquipment	LoadFactor	0.29	0.29
tblOffRoadEquipment	LoadFactor	0.38	0.38
tblOffRoadEquipment	LoadFactor	0.29	0.29
tblOffRoadEquipment	OffRoadEquipmentType		Cranes
tblOffRoadEquipment	OffRoadEquipmentType		Air Compressors
tblOffRoadEquipment	OffRoadEquipmentType		Concrete/Industrial Saws
tblOffRoadEquipment	OffRoadEquipmentType		Excavators
tblOffRoadEquipment	OffRoadEquipmentType		Plate Compactors
tblOffRoadEquipment	OffRoadEquipmentType		Air Compressors

Orange Park Acres, IRWD - Orange County, Winter

EMFAC Off-Model Adjustment Factors for Gasoline Light Duty Vehicle to Account for the SAFE Vehicle Rule Not Applied

tblOffRoadEquipment	OffRoadEquipmentType			Cranes
tblOffRoadEquipment	OffRoadEquipmentUnitAmount	1.00		0.00
tblOffRoadEquipment	OffRoadEquipmentUnitAmount	1.00		0.00
tblOffRoadEquipment	OffRoadEquipmentUnitAmount	2.00		0.00
tblOffRoadEquipment	OffRoadEquipmentUnitAmount	1.00		0.00
tblOffRoadEquipment	OffRoadEquipmentUnitAmount	1.00		0.00
tblOffRoadEquipment	OffRoadEquipmentUnitAmount	1.00		0.00
tblOffRoadEquipment	OffRoadEquipmentUnitAmount	2.00		0.00
tblOffRoadEquipment	OffRoadEquipmentUnitAmount	2.00		1.00
tblOffRoadEquipment	OffRoadEquipmentUnitAmount	1.00		0.00
tblTripsAndVMT	HaulingTripNumber	0.00		100.00
tblTripsAndVMT	HaulingTripNumber	0.00		20.00

2.0 Emissions Summary

2.1 Overall Construction (Maximum Daily Emission)

Unmitigated Construction

	ROG	NOx	CO	SO2	Fugitive PM10	Exhaust PM10	PM10 Total	Fugitive PM2.5	Exhaust PM2.5	PM2.5 Total	Bio- CO2	NBio- CO2	Total CO2	CH4	N2O	CO2e
Year	lb/day										lb/day					
2022	1.4907	12.7551	14.1979	0.0270	0.4751	0.6185	0.8338	0.0857	0.5913	0.6484	0.0000	2,578.9259	2,578.9259	0.5005	0.0216	2,595.1836
Maximum	1.4907	12.7551	14.1979	0.0270	0.4751	0.6185	0.8338	0.0857	0.5913	0.6484	0.0000	2,578.9259	2,578.9259	0.5005	0.0216	2,595.1836

Mitigated Construction

Orange Park Acres, IRWD - Orange County, Winter

EMFAC Off-Model Adjustment Factors for Gasoline Light Duty Vehicle to Account for the SAFE Vehicle Rule Not Applied

	ROG	NOx	CO	SO2	Fugitive PM10	Exhaust PM10	PM10 Total	Fugitive PM2.5	Exhaust PM2.5	PM2.5 Total	Bio- CO2	NBio- CO2	Total CO2	CH4	N2O	CO2e
Year	lb/day										lb/day					
2022	1.4907	12.7551	14.1979	0.0270	0.2576	0.6185	0.8333	0.0571	0.5913	0.6484	0.0000	2,578.9259	2,578.9259	0.5005	0.0216	2,595.1836
Maximum	1.4907	12.7551	14.1979	0.0270	0.2576	0.6185	0.8333	0.0571	0.5913	0.6484	0.0000	2,578.9259	2,578.9259	0.5005	0.0216	2,595.1836

	ROG	NOx	CO	SO2	Fugitive PM10	Exhaust PM10	PM10 Total	Fugitive PM2.5	Exhaust PM2.5	PM2.5 Total	Bio- CO2	NBio- CO2	Total CO2	CH4	N2O	CO2e
Percent Reduction	0.00	0.00	0.00	0.00	45.79	0.00	0.05	33.38	0.00	0.01	0.00	0.00	0.00	0.00	0.00	0.00

2.2 Overall Operational
Unmitigated Operational

	ROG	NOx	CO	SO2	Fugitive PM10	Exhaust PM10	PM10 Total	Fugitive PM2.5	Exhaust PM2.5	PM2.5 Total	Bio- CO2	NBio- CO2	Total CO2	CH4	N2O	CO2e
Category	lb/day										lb/day					
Area	0.3711	0.0000	1.0000e-004	0.0000		0.0000	0.0000		0.0000	0.0000		2.2000e-004	2.2000e-004	0.0000	0.0000	2.3000e-004
Energy	0.0000	0.0000	0.0000	0.0000		0.0000	0.0000		0.0000	0.0000		0.0000	0.0000	0.0000	0.0000	0.0000
Mobile	0.0000	0.0000	0.0000	0.0000	0.0000	0.0000	0.0000	0.0000	0.0000	0.0000		0.0000	0.0000	0.0000	0.0000	0.0000
Total	0.3711	0.0000	1.0000e-004	0.0000	0.0000	0.0000	0.0000	0.0000	0.0000	0.0000		2.2000e-004	2.2000e-004	0.0000	0.0000	2.3000e-004

Orange Park Acres, IRWD - Orange County, Winter

EMFAC Off-Model Adjustment Factors for Gasoline Light Duty Vehicle to Account for the SAFE Vehicle Rule Not Applied

Mitigated Operational

	ROG	NOx	CO	SO2	Fugitive PM10	Exhaust PM10	PM10 Total	Fugitive PM2.5	Exhaust PM2.5	PM2.5 Total	Bio- CO2	NBio- CO2	Total CO2	CH4	N2O	CO2e
Category	lb/day										lb/day					
Area	0.3711	0.0000	1.0000e-004	0.0000		0.0000	0.0000		0.0000	0.0000		2.2000e-004	2.2000e-004	0.0000		2.3000e-004
Energy	0.0000	0.0000	0.0000	0.0000		0.0000	0.0000		0.0000	0.0000		0.0000	0.0000	0.0000	0.0000	0.0000
Mobile	0.0000	0.0000	0.0000	0.0000	0.0000	0.0000	0.0000	0.0000	0.0000	0.0000		0.0000	0.0000	0.0000	0.0000	0.0000
Total	0.3711	0.0000	1.0000e-004	0.0000	0.0000	0.0000	0.0000	0.0000	0.0000	0.0000		2.2000e-004	2.2000e-004	0.0000	0.0000	2.3000e-004

	ROG	NOx	CO	SO2	Fugitive PM10	Exhaust PM10	PM10 Total	Fugitive PM2.5	Exhaust PM2.5	PM2.5 Total	Bio- CO2	NBio-CO2	Total CO2	CH4	N2O	CO2e
Percent Reduction	0.00	0.00	0.00	0.00	0.00	0.00	0.00	0.00	0.00	0.00	0.00	0.00	0.00	0.00	0.00	0.00

3.0 Construction Detail

Construction Phase

Phase Number	Phase Name	Phase Type	Start Date	End Date	Num Days Week	Num Days	Phase Description
1	Demolition	Demolition	1/17/2022	1/29/2022	6	12	
2	Grading/Trenching	Grading	2/1/2022	3/2/2022	6	26	
3	Building Construction	Building Construction	3/3/2022	8/2/2022	6	131	
4	Paving	Paving	8/3/2022	8/16/2022	6	12	

Acres of Grading (Site Preparation Phase): 0

Orange Park Acres, IRWD - Orange County, Winter

EMFAC Off-Model Adjustment Factors for Gasoline Light Duty Vehicle to Account for the SAFE Vehicle Rule Not Applied

Acres of Grading (Grading Phase): 0

Acres of Paving: 0

Residential Indoor: 0; Residential Outdoor: 0; Non-Residential Indoor: 0; Non-Residential Outdoor: 0; Striped Parking Area: 0 (Architectural Coating –

OffRoad Equipment

Phase Name	Offroad Equipment Type	Amount	Usage Hours	Horse Power	Load Factor
Demolition	Cranes	1	8.00	231	0.29
Paving	Cement and Mortar Mixers	4	6.00	9	0.56
Demolition	Concrete/Industrial Saws	0	8.00	81	0.73
Building Construction	Cranes	0	4.00	231	0.29
Building Construction	Forklifts	0	6.00	89	0.20
Grading/Trenching	Graders	0	6.00	187	0.41
Demolition	Air Compressors	1	8.00	78	0.48
Paving	Pavers	1	7.00	130	0.42
Paving	Rollers	1	7.00	80	0.38
Demolition	Rubber Tired Dozers	0	1.00	247	0.40
Grading/Trenching	Rubber Tired Dozers	0	6.00	247	0.40
Building Construction	Tractors/Loaders/Backhoes	0	8.00	97	0.37
Demolition	Tractors/Loaders/Backhoes	1	6.00	97	0.37
Grading/Trenching	Tractors/Loaders/Backhoes	1	7.00	97	0.37
Paving	Tractors/Loaders/Backhoes	0	7.00	97	0.37
Grading/Trenching	Concrete/Industrial Saws	1	8.00	81	0.73
Grading/Trenching	Excavators	1	8.00	158	0.38
Grading/Trenching	Plate Compactors	2	8.00	8	0.43
Grading/Trenching	Air Compressors	1	8.00	78	0.48
Grading/Trenching	Cranes	1	8.00	231	0.29

Trips and VMT

Orange Park Acres, IRWD - Orange County, Winter

EMFAC Off-Model Adjustment Factors for Gasoline Light Duty Vehicle to Account for the SAFE Vehicle Rule Not Applied

Phase Name	Offroad Equipment Count	Worker Trip Number	Vendor Trip Number	Hauling Trip Number	Worker Trip Length	Vendor Trip Length	Hauling Trip Length	Worker Vehicle Class	Vendor Vehicle Class	Hauling Vehicle Class
Demolition	3	8.00	0.00	20.00	14.70	6.90	20.00	LD_Mix	HDT_Mix	HHDT
Grading/Trenching	7	18.00	0.00	20.00	14.70	6.90	20.00	LD_Mix	HDT_Mix	HHDT
Building Construction	0	7.00	3.00	100.00	14.70	6.90	20.00	LD_Mix	HDT_Mix	HHDT
Paving	6	15.00	0.00	20.00	14.70	6.90	20.00	LD_Mix	HDT_Mix	HHDT

3.1 Mitigation Measures Construction

Water Exposed Area

3.2 Demolition - 2022

Unmitigated Construction On-Site

	ROG	NOx	CO	SO2	Fugitive PM10	Exhaust PM10	PM10 Total	Fugitive PM2.5	Exhaust PM2.5	PM2.5 Total	Bio- CO2	NBio- CO2	Total CO2	CH4	N2O	CO2e
Category	lb/day										lb/day					
Fugitive Dust					0.3567	0.0000	0.3567	0.0540	0.0000	0.0540			0.0000			0.0000
Off-Road	0.7668	7.2916	5.9765	0.0120		0.3491	0.3491		0.3299	0.3299		1,156.3623	1,156.3623	0.2771		1,163.2887
Total	0.7668	7.2916	5.9765	0.0120	0.3567	0.3491	0.7058	0.0540	0.3299	0.3839		1,156.3623	1,156.3623	0.2771		1,163.2887

Unmitigated Construction Off-Site

	ROG	NOx	CO	SO2	Fugitive PM10	Exhaust PM10	PM10 Total	Fugitive PM2.5	Exhaust PM2.5	PM2.5 Total	Bio- CO2	NBio- CO2	Total CO2	CH4	N2O	CO2e
--	-----	-----	----	-----	---------------	--------------	------------	----------------	---------------	-------------	----------	-----------	-----------	-----	-----	------

Orange Park Acres, IRWD - Orange County, Winter

EMFAC Off-Model Adjustment Factors for Gasoline Light Duty Vehicle to Account for the SAFE Vehicle Rule Not Applied

Category	lb/day										lb/day					
Hauling	6.5900e-003	0.2697	0.0740	9.9000e-004	0.0291	1.9700e-003	0.0310	7.9600e-003	1.8800e-003	9.8400e-003		112.7095	112.7095	0.0107	0.0181	118.3574
Vendor	0.0000	0.0000	0.0000	0.0000	0.0000	0.0000	0.0000	0.0000	0.0000	0.0000		0.0000	0.0000	0.0000	0.0000	0.0000
Worker	0.0262	0.0178	0.2447	7.4000e-004	0.0894	4.8000e-004	0.0899	0.0237	4.4000e-004	0.0242		75.0001	75.0001	1.8900e-003	1.8800e-003	75.6089
Total	0.0328	0.2874	0.3186	1.7300e-003	0.1185	2.4500e-003	0.1209	0.0317	2.3200e-003	0.0340		187.7096	187.7096	0.0126	0.0199	193.9663

Mitigated Construction On-Site

	ROG	NOx	CO	SO2	Fugitive PM10	Exhaust PM10	PM10 Total	Fugitive PM2.5	Exhaust PM2.5	PM2.5 Total	Bio- CO2	NBio- CO2	Total CO2	CH4	N2O	CO2e
Category	lb/day										lb/day					
Fugitive Dust					0.1391	0.0000	0.1391	0.0211	0.0000	0.0211			0.0000			0.0000
Off-Road	0.7668	7.2916	5.9765	0.0120		0.3491	0.3491		0.3299	0.3299	0.0000	1,156.3623	1,156.3623	0.2771		1,163.2887
Total	0.7668	7.2916	5.9765	0.0120	0.1391	0.3491	0.4882	0.0211	0.3299	0.3510	0.0000	1,156.3623	1,156.3623	0.2771		1,163.2887

Mitigated Construction Off-Site

	ROG	NOx	CO	SO2	Fugitive PM10	Exhaust PM10	PM10 Total	Fugitive PM2.5	Exhaust PM2.5	PM2.5 Total	Bio- CO2	NBio- CO2	Total CO2	CH4	N2O	CO2e
--	-----	-----	----	-----	---------------	--------------	------------	----------------	---------------	-------------	----------	-----------	-----------	-----	-----	------

Orange Park Acres, IRWD - Orange County, Winter

EMFAC Off-Model Adjustment Factors for Gasoline Light Duty Vehicle to Account for the SAFE Vehicle Rule Not Applied

Category	lb/day										lb/day					
Hauling	6.5900e-003	0.2697	0.0740	9.9000e-004	0.0291	1.9700e-003	0.0310	7.9600e-003	1.8800e-003	9.8400e-003		112.7095	112.7095	0.0107	0.0181	118.3574
Vendor	0.0000	0.0000	0.0000	0.0000	0.0000	0.0000	0.0000	0.0000	0.0000	0.0000		0.0000	0.0000	0.0000	0.0000	0.0000
Worker	0.0262	0.0178	0.2447	7.4000e-004	0.0894	4.8000e-004	0.0899	0.0237	4.4000e-004	0.0242		75.0001	75.0001	1.8900e-003	1.8800e-003	75.6089
Total	0.0328	0.2874	0.3186	1.7300e-003	0.1185	2.4500e-003	0.1209	0.0317	2.3200e-003	0.0340		187.7096	187.7096	0.0126	0.0199	193.9663

3.3 Grading/Trenching - 2022

Unmitigated Construction On-Site

	ROG	NOx	CO	SO2	Fugitive PM10	Exhaust PM10	PM10 Total	Fugitive PM2.5	Exhaust PM2.5	PM2.5 Total	Bio- CO2	NBio- CO2	Total CO2	CH4	N2O	CO2e
Category	lb/day										lb/day					
Fugitive Dust					7.0000e-004	0.0000	7.0000e-004	1.1000e-004	0.0000	1.1000e-004			0.0000			0.0000
Off-Road	1.4287	12.5906	13.6133	0.0248		0.6165	0.6165		0.5894	0.5894		2,358.1560	2,358.1560	0.4913		2,370.4371
Total	1.4287	12.5906	13.6133	0.0248	7.0000e-004	0.6165	0.6172	1.1000e-004	0.5894	0.5895		2,358.1560	2,358.1560	0.4913		2,370.4371

Unmitigated Construction Off-Site

	ROG	NOx	CO	SO2	Fugitive PM10	Exhaust PM10	PM10 Total	Fugitive PM2.5	Exhaust PM2.5	PM2.5 Total	Bio- CO2	NBio- CO2	Total CO2	CH4	N2O	CO2e
--	-----	-----	----	-----	---------------	--------------	------------	----------------	---------------	-------------	----------	-----------	-----------	-----	-----	------

Orange Park Acres, IRWD - Orange County, Winter

EMFAC Off-Model Adjustment Factors for Gasoline Light Duty Vehicle to Account for the SAFE Vehicle Rule Not Applied

Category	lb/day										lb/day					
Hauling	3.0400e-003	0.1245	0.0341	4.6000e-004	0.0134	9.1000e-004	0.0143	3.6700e-003	8.7000e-004	4.5400e-003		52.0198	52.0198	4.9500e-003	8.3300e-003	54.6265
Vendor	0.0000	0.0000	0.0000	0.0000	0.0000	0.0000	0.0000	0.0000	0.0000	0.0000		0.0000	0.0000	0.0000	0.0000	0.0000
Worker	0.0590	0.0400	0.5505	1.6700e-003	0.2012	1.0800e-003	0.2023	0.0534	1.0000e-003	0.0544		168.7502	168.7502	4.2600e-003	4.2400e-003	170.1200
Total	0.0620	0.1644	0.5846	2.1300e-003	0.2146	1.9900e-003	0.2166	0.0570	1.8700e-003	0.0589		220.7700	220.7700	9.2100e-003	0.0126	224.7465

Mitigated Construction On-Site

	ROG	NOx	CO	SO2	Fugitive PM10	Exhaust PM10	PM10 Total	Fugitive PM2.5	Exhaust PM2.5	PM2.5 Total	Bio- CO2	NBio- CO2	Total CO2	CH4	N2O	CO2e
Category	lb/day										lb/day					
Fugitive Dust					2.7000e-004	0.0000	2.7000e-004	4.0000e-005	0.0000	4.0000e-005			0.0000			0.0000
Off-Road	1.4287	12.5906	13.6133	0.0248		0.6165	0.6165		0.5894	0.5894	0.0000	2,358.1560	2,358.1560	0.4913		2,370.4371
Total	1.4287	12.5906	13.6133	0.0248	2.7000e-004	0.6165	0.6167	4.0000e-005	0.5894	0.5895	0.0000	2,358.1560	2,358.1560	0.4913		2,370.4371

Mitigated Construction Off-Site

	ROG	NOx	CO	SO2	Fugitive PM10	Exhaust PM10	PM10 Total	Fugitive PM2.5	Exhaust PM2.5	PM2.5 Total	Bio- CO2	NBio- CO2	Total CO2	CH4	N2O	CO2e
--	-----	-----	----	-----	---------------	--------------	------------	----------------	---------------	-------------	----------	-----------	-----------	-----	-----	------

Orange Park Acres, IRWD - Orange County, Winter

EMFAC Off-Model Adjustment Factors for Gasoline Light Duty Vehicle to Account for the SAFE Vehicle Rule Not Applied

Category	lb/day										lb/day					
Hauling	3.0400e-003	0.1245	0.0341	4.6000e-004	0.0134	9.1000e-004	0.0143	3.6700e-003	8.7000e-004	4.5400e-003		52.0198	52.0198	4.9500e-003	8.3300e-003	54.6265
Vendor	0.0000	0.0000	0.0000	0.0000	0.0000	0.0000	0.0000	0.0000	0.0000	0.0000		0.0000	0.0000	0.0000	0.0000	0.0000
Worker	0.0590	0.0400	0.5505	1.6700e-003	0.2012	1.0800e-003	0.2023	0.0534	1.0000e-003	0.0544		168.7502	168.7502	4.2600e-003	4.2400e-003	170.1200
Total	0.0620	0.1644	0.5846	2.1300e-003	0.2146	1.9900e-003	0.2166	0.0570	1.8700e-003	0.0589		220.7700	220.7700	9.2100e-003	0.0126	224.7465

3.4 Building Construction - 2022

Unmitigated Construction On-Site

	ROG	NOx	CO	SO2	Fugitive PM10	Exhaust PM10	PM10 Total	Fugitive PM2.5	Exhaust PM2.5	PM2.5 Total	Bio- CO2	NBio- CO2	Total CO2	CH4	N2O	CO2e
Category	lb/day										lb/day					
Off-Road	0.0000	0.0000	0.0000	0.0000		0.0000	0.0000		0.0000	0.0000		0.0000	0.0000	0.0000		0.0000
Total	0.0000	0.0000	0.0000	0.0000		0.0000	0.0000		0.0000	0.0000		0.0000	0.0000	0.0000		0.0000

Unmitigated Construction Off-Site

	ROG	NOx	CO	SO2	Fugitive PM10	Exhaust PM10	PM10 Total	Fugitive PM2.5	Exhaust PM2.5	PM2.5 Total	Bio- CO2	NBio- CO2	Total CO2	CH4	N2O	CO2e
Category	lb/day										lb/day					

Orange Park Acres, IRWD - Orange County, Winter

EMFAC Off-Model Adjustment Factors for Gasoline Light Duty Vehicle to Account for the SAFE Vehicle Rule Not Applied

Hauling	3.0200e-003	0.1235	0.0339	4.6000e-004	0.0133	9.0000e-004	0.0142	3.6500e-003	8.6000e-004	4.5100e-003		51.6227	51.6227	4.9100e-003	8.2700e-003	54.2095
Vendor	4.9200e-003	0.1399	0.0495	5.7000e-004	0.0192	1.3100e-003	0.0205	5.5200e-003	1.2600e-003	6.7800e-003		62.2268	62.2268	3.5600e-003	8.9200e-003	64.9751
Worker	0.0229	0.0155	0.2141	6.5000e-004	0.0782	4.2000e-004	0.0787	0.0208	3.9000e-004	0.0211		65.6251	65.6251	1.6600e-003	1.6500e-003	66.1578
Total	0.0309	0.2789	0.2975	1.6800e-003	0.1107	2.6300e-003	0.1134	0.0299	2.5100e-003	0.0324		179.4745	179.4745	0.0101	0.0188	185.3424

Mitigated Construction On-Site

	ROG	NOx	CO	SO2	Fugitive PM10	Exhaust PM10	PM10 Total	Fugitive PM2.5	Exhaust PM2.5	PM2.5 Total	Bio- CO2	NBio- CO2	Total CO2	CH4	N2O	CO2e
Category	lb/day										lb/day					
Off-Road	0.0000	0.0000	0.0000	0.0000		0.0000	0.0000		0.0000	0.0000	0.0000	0.0000	0.0000	0.0000		0.0000
Total	0.0000	0.0000	0.0000	0.0000		0.0000	0.0000		0.0000	0.0000	0.0000	0.0000	0.0000	0.0000		0.0000

Mitigated Construction Off-Site

	ROG	NOx	CO	SO2	Fugitive PM10	Exhaust PM10	PM10 Total	Fugitive PM2.5	Exhaust PM2.5	PM2.5 Total	Bio- CO2	NBio- CO2	Total CO2	CH4	N2O	CO2e
Category	lb/day										lb/day					
Hauling	3.0200e-003	0.1235	0.0339	4.6000e-004	0.0133	9.0000e-004	0.0142	3.6500e-003	8.6000e-004	4.5100e-003		51.6227	51.6227	4.9100e-003	8.2700e-003	54.2095

Orange Park Acres, IRWD - Orange County, Winter

EMFAC Off-Model Adjustment Factors for Gasoline Light Duty Vehicle to Account for the SAFE Vehicle Rule Not Applied

Vendor	4.9200e-003	0.1399	0.0495	5.7000e-004	0.0192	1.3100e-003	0.0205	5.5200e-003	1.2600e-003	6.7800e-003		62.2268	62.2268	3.5600e-003	8.9200e-003	64.9751
Worker	0.0229	0.0155	0.2141	6.5000e-004	0.0782	4.2000e-004	0.0787	0.0208	3.9000e-004	0.0211		65.6251	65.6251	1.6600e-003	1.6500e-003	66.1578
Total	0.0309	0.2789	0.2975	1.6800e-003	0.1107	2.6300e-003	0.1134	0.0299	2.5100e-003	0.0324		179.4745	179.4745	0.0101	0.0188	185.3424

3.5 Paving - 2022

Unmitigated Construction On-Site

	ROG	NOx	CO	SO2	Fugitive PM10	Exhaust PM10	PM10 Total	Fugitive PM2.5	Exhaust PM2.5	PM2.5 Total	Bio- CO2	NBio- CO2	Total CO2	CH4	N2O	CO2e
Category	lb/day										lb/day					
Off-Road	0.5028	4.4512	5.0766	8.5400e-003		0.2172	0.2172		0.2033	0.2033		772.2405	772.2405	0.2165		777.6524
Paving	0.0000					0.0000	0.0000		0.0000	0.0000			0.0000			0.0000
Total	0.5028	4.4512	5.0766	8.5400e-003		0.2172	0.2172		0.2033	0.2033		772.2405	772.2405	0.2165		777.6524

Unmitigated Construction Off-Site

	ROG	NOx	CO	SO2	Fugitive PM10	Exhaust PM10	PM10 Total	Fugitive PM2.5	Exhaust PM2.5	PM2.5 Total	Bio- CO2	NBio- CO2	Total CO2	CH4	N2O	CO2e
Category	lb/day										lb/day					
Hauling	6.5900e-003	0.2697	0.0740	9.9000e-004	0.0291	1.9700e-003	0.0310	7.9600e-003	1.8800e-003	9.8400e-003		112.7095	112.7095	0.0107	0.0181	118.3574

Orange Park Acres, IRWD - Orange County, Winter

EMFAC Off-Model Adjustment Factors for Gasoline Light Duty Vehicle to Account for the SAFE Vehicle Rule Not Applied

Vendor	0.0000	0.0000	0.0000	0.0000	0.0000	0.0000	0.0000	0.0000	0.0000	0.0000		0.0000	0.0000	0.0000	0.0000	0.0000
Worker	0.0491	0.0333	0.4587	1.3900e-003	0.1677	9.0000e-004	0.1686	0.0445	8.3000e-004	0.0453		140.6252	140.6252	3.5500e-003	3.5300e-003	141.7667
Total	0.0557	0.3030	0.5327	2.3800e-003	0.1967	2.8700e-003	0.1996	0.0524	2.7100e-003	0.0551		253.3347	253.3347	0.0143	0.0216	260.1241

Mitigated Construction On-Site

	ROG	NOx	CO	SO2	Fugitive PM10	Exhaust PM10	PM10 Total	Fugitive PM2.5	Exhaust PM2.5	PM2.5 Total	Bio- CO2	NBio- CO2	Total CO2	CH4	N2O	CO2e
Category	lb/day										lb/day					
Off-Road	0.5028	4.4512	5.0766	8.5400e-003		0.2172	0.2172		0.2033	0.2033	0.0000	772.2405	772.2405	0.2165		777.6524
Paving	0.0000					0.0000	0.0000		0.0000	0.0000			0.0000			0.0000
Total	0.5028	4.4512	5.0766	8.5400e-003		0.2172	0.2172		0.2033	0.2033	0.0000	772.2405	772.2405	0.2165		777.6524

Mitigated Construction Off-Site

	ROG	NOx	CO	SO2	Fugitive PM10	Exhaust PM10	PM10 Total	Fugitive PM2.5	Exhaust PM2.5	PM2.5 Total	Bio- CO2	NBio- CO2	Total CO2	CH4	N2O	CO2e
Category	lb/day										lb/day					
Hauling	6.5900e-003	0.2697	0.0740	9.9000e-004	0.0291	1.9700e-003	0.0310	7.9600e-003	1.8800e-003	9.8400e-003		112.7095	112.7095	0.0107	0.0181	118.3574

Orange Park Acres, IRWD - Orange County, Winter

EMFAC Off-Model Adjustment Factors for Gasoline Light Duty Vehicle to Account for the SAFE Vehicle Rule Not Applied

Vendor	0.0000	0.0000	0.0000	0.0000	0.0000	0.0000	0.0000	0.0000	0.0000	0.0000	0.0000	0.0000	0.0000	0.0000	0.0000	0.0000
Worker	0.0491	0.0333	0.4587	1.3900e-003	0.1677	9.0000e-004	0.1686	0.0445	8.3000e-004	0.0453		140.6252	140.6252	3.5500e-003	3.5300e-003	141.7667
Total	0.0557	0.3030	0.5327	2.3800e-003	0.1967	2.8700e-003	0.1996	0.0524	2.7100e-003	0.0551		253.3347	253.3347	0.0143	0.0216	260.1241

4.0 Operational Detail - Mobile

4.1 Mitigation Measures Mobile

	ROG	NOx	CO	SO2	Fugitive PM10	Exhaust PM10	PM10 Total	Fugitive PM2.5	Exhaust PM2.5	PM2.5 Total	Bio- CO2	NBio- CO2	Total CO2	CH4	N2O	CO2e
Category	lb/day										lb/day					
Mitigated	0.0000	0.0000	0.0000	0.0000	0.0000	0.0000	0.0000	0.0000	0.0000	0.0000		0.0000	0.0000	0.0000	0.0000	0.0000
Unmitigated	0.0000	0.0000	0.0000	0.0000	0.0000	0.0000	0.0000	0.0000	0.0000	0.0000		0.0000	0.0000	0.0000	0.0000	0.0000

4.2 Trip Summary Information

Land Use	Average Daily Trip Rate			Unmitigated Annual VMT	Mitigated Annual VMT
	Weekday	Saturday	Sunday		
User Defined Industrial	0.00	0.00	0.00		
Total	0.00	0.00	0.00		

4.3 Trip Type Information

	Miles	Trip %	Trip Purpose %
--	-------	--------	----------------

Orange Park Acres, IRWD - Orange County, Winter

EMFAC Off-Model Adjustment Factors for Gasoline Light Duty Vehicle to Account for the SAFE Vehicle Rule Not Applied

Land Use	H-W or C-W	H-S or C-C	H-O or C-NW	H-W or C-W	H-S or C-C	H-O or C-NW	Primary	Diverted	Pass-by
User Defined Industrial	16.60	8.40	6.90	0.00	0.00	0.00	0	0	0

4.4 Fleet Mix

Land Use	LDA	LDT1	LDT2	MDV	LHD1	LHD2	MHD	HHD	OBUS	UBUS	MCY	SBUS	MH
User Defined Industrial	0.542853	0.058126	0.187899	0.130925	0.024443	0.006426	0.014590	0.004841	0.000666	0.000390	0.024092	0.000735	0.00401

5.0 Energy Detail

Historical Energy Use: N

5.1 Mitigation Measures Energy

	ROG	NOx	CO	SO2	Fugitive PM10	Exhaust PM10	PM10 Total	Fugitive PM2.5	Exhaust PM2.5	PM2.5 Total	Bio- CO2	NBio- CO2	Total CO2	CH4	N2O	CO2e
Category	lb/day										lb/day					
NaturalGas Mitigated	0.0000	0.0000	0.0000	0.0000		0.0000	0.0000		0.0000	0.0000		0.0000	0.0000	0.0000	0.0000	0.0000
NaturalGas Unmitigated	0.0000	0.0000	0.0000	0.0000		0.0000	0.0000		0.0000	0.0000		0.0000	0.0000	0.0000	0.0000	0.0000

5.2 Energy by Land Use - NaturalGas

Unmitigated

NaturalGas Use	ROG	NOx	CO	SO2	Fugitive PM10	Exhaust PM10	PM10 Total	Fugitive PM2.5	Exhaust PM2.5	PM2.5 Total	Bio- CO2	NBio- CO2	Total CO2	CH4	N2O	CO2e
----------------	-----	-----	----	-----	---------------	--------------	------------	----------------	---------------	-------------	----------	-----------	-----------	-----	-----	------

Orange Park Acres, IRWD - Orange County, Winter

EMFAC Off-Model Adjustment Factors for Gasoline Light Duty Vehicle to Account for the SAFE Vehicle Rule Not Applied

Land Use	kBTU/yr	lb/day										lb/day					
User Defined Industrial	0	0.0000	0.0000	0.0000	0.0000		0.0000	0.0000		0.0000	0.0000		0.0000	0.0000	0.0000	0.0000	0.0000
Total		0.0000	0.0000	0.0000	0.0000		0.0000	0.0000		0.0000	0.0000		0.0000	0.0000	0.0000	0.0000	0.0000

Mitigated

	Natural Gas Use	ROG	NOx	CO	SO2	Fugitive PM10	Exhaust PM10	PM10 Total	Fugitive PM2.5	Exhaust PM2.5	PM2.5 Total	Bio- CO2	NBio- CO2	Total CO2	CH4	N2O	CO2e
Land Use	kBTU/yr	lb/day										lb/day					
User Defined Industrial	0	0.0000	0.0000	0.0000	0.0000		0.0000	0.0000		0.0000	0.0000		0.0000	0.0000	0.0000	0.0000	0.0000
Total		0.0000	0.0000	0.0000	0.0000		0.0000	0.0000		0.0000	0.0000		0.0000	0.0000	0.0000	0.0000	0.0000

6.0 Area Detail

6.1 Mitigation Measures Area

ROG	NOx	CO	SO2	Fugitive PM10	Exhaust PM10	PM10 Total	Fugitive PM2.5	Exhaust PM2.5	PM2.5 Total	Bio- CO2	NBio- CO2	Total CO2	CH4	N2O	CO2e
-----	-----	----	-----	---------------	--------------	------------	----------------	---------------	-------------	----------	-----------	-----------	-----	-----	------

Orange Park Acres, IRWD - Orange County, Winter

EMFAC Off-Model Adjustment Factors for Gasoline Light Duty Vehicle to Account for the SAFE Vehicle Rule Not Applied

Category	lb/day										lb/day					
Mitigated	0.3711	0.0000	1.0000e-004	0.0000		0.0000	0.0000		0.0000	0.0000		2.2000e-004	2.2000e-004	0.0000		2.3000e-004
Unmitigated	0.3711	0.0000	1.0000e-004	0.0000		0.0000	0.0000		0.0000	0.0000		2.2000e-004	2.2000e-004	0.0000		2.3000e-004

6.2 Area by SubCategory

Unmitigated

	ROG	NOx	CO	SO2	Fugitive PM10	Exhaust PM10	PM10 Total	Fugitive PM2.5	Exhaust PM2.5	PM2.5 Total	Bio- CO2	NBio- CO2	Total CO2	CH4	N2O	CO2e
SubCategory	lb/day										lb/day					
Architectural Coating	0.0422					0.0000	0.0000		0.0000	0.0000			0.0000			0.0000
Consumer Products	0.3289					0.0000	0.0000		0.0000	0.0000			0.0000			0.0000
Landscaping	1.0000e-005	0.0000	1.0000e-004	0.0000		0.0000	0.0000		0.0000	0.0000		2.2000e-004	2.2000e-004	0.0000		2.3000e-004
Total	0.3711	0.0000	1.0000e-004	0.0000		0.0000	0.0000		0.0000	0.0000		2.2000e-004	2.2000e-004	0.0000		2.3000e-004

Mitigated

	ROG	NOx	CO	SO2	Fugitive PM10	Exhaust PM10	PM10 Total	Fugitive PM2.5	Exhaust PM2.5	PM2.5 Total	Bio- CO2	NBio- CO2	Total CO2	CH4	N2O	CO2e
SubCategory	lb/day										lb/day					

Orange Park Acres, IRWD - Orange County, Winter

EMFAC Off-Model Adjustment Factors for Gasoline Light Duty Vehicle to Account for the SAFE Vehicle Rule Not Applied

Architectural Coating	0.0422				0.0000	0.0000		0.0000	0.0000			0.0000		0.0000
Consumer Products	0.3289				0.0000	0.0000		0.0000	0.0000			0.0000		0.0000
Landscaping	1.0000e-005	0.0000	1.0000e-004	0.0000	0.0000	0.0000		0.0000	0.0000		2.2000e-004	2.2000e-004	0.0000	2.3000e-004
Total	0.3711	0.0000	1.0000e-004	0.0000	0.0000	0.0000		0.0000	0.0000		2.2000e-004	2.2000e-004	0.0000	2.3000e-004

7.0 Water Detail

7.1 Mitigation Measures Water

8.0 Waste Detail

8.1 Mitigation Measures Waste

9.0 Operational Offroad

Equipment Type	Number	Hours/Day	Days/Year	Horse Power	Load Factor	Fuel Type
----------------	--------	-----------	-----------	-------------	-------------	-----------

10.0 Stationary Equipment

Fire Pumps and Emergency Generators

Equipment Type	Number	Hours/Day	Hours/Year	Horse Power	Load Factor	Fuel Type
----------------	--------	-----------	------------	-------------	-------------	-----------

Boilers

Equipment Type	Number	Heat Input/Day	Heat Input/Year	Boiler Rating	Fuel Type
----------------	--------	----------------	-----------------	---------------	-----------

User Defined Equipment

Equipment Type	Number
----------------	--------

Orange Park Acres, IRWD - Orange County, Winter

EMFAC Off-Model Adjustment Factors for Gasoline Light Duty Vehicle to Account for the SAFE Vehicle Rule Not Applied

11.0 Vegetation

Orange Park Acres, IRWD - Orange County, Summer

EMFAC Off-Model Adjustment Factors for Gasoline Light Duty Vehicle to Account for the SAFE Vehicle Rule Not Applied

**Orange Park Acres, IRWD
Orange County, Summer**

1.0 Project Characteristics

1.1 Land Usage

Land Uses	Size	Metric	Lot Acreage	Floor Surface Area	Population
User Defined Industrial	1.00	User Defined Unit	0.38	16,610.00	0

1.2 Other Project Characteristics

Urbanization	Urban	Wind Speed (m/s)	2.2	Precipitation Freq (Days)	30
Climate Zone	8			Operational Year	2022
Utility Company	Southern California Edison				
CO2 Intensity (lb/MWhr)	390.98	CH4 Intensity (lb/MWhr)	0.033	N2O Intensity (lb/MWhr)	0.004

1.3 User Entered Comments & Non-Default Data

- Project Characteristics -
- Land Use - Estimated lot acreage
- Construction Phase - .
- Off-road Equipment - .
- Off-road Equipment - .
- Off-road Equipment - No building construction, minor modifications inside building and install of outdoor equipment.
- Off-road Equipment - .
- Grading - .
- Demolition - .
- Trips and VMT - .
- Energy Use - no natural gas required
- Construction Off-road Equipment Mitigation -

Orange Park Acres, IRWD - Orange County, Summer

EMFAC Off-Model Adjustment Factors for Gasoline Light Duty Vehicle to Account for the SAFE Vehicle Rule Not Applied

Table Name	Column Name	Default Value	New Value
tblConstructionPhase	NumDays	100.00	131.00
tblConstructionPhase	NumDays	10.00	12.00
tblConstructionPhase	NumDays	2.00	26.00
tblConstructionPhase	NumDays	5.00	12.00
tblConstructionPhase	NumDaysWeek	5.00	6.00
tblConstructionPhase	NumDaysWeek	5.00	6.00
tblConstructionPhase	NumDaysWeek	5.00	6.00
tblConstructionPhase	NumDaysWeek	5.00	6.00
tblConstructionPhase	PhaseEndDate	6/22/2022	8/2/2022
tblConstructionPhase	PhaseEndDate	1/28/2022	1/29/2022
tblConstructionPhase	PhaseEndDate	2/2/2022	3/2/2022
tblConstructionPhase	PhaseEndDate	6/29/2022	8/16/2022
tblConstructionPhase	PhaseStartDate	2/3/2022	3/3/2022
tblConstructionPhase	PhaseStartDate	6/23/2022	8/3/2022
tblEnergyUse	NT24E	0.00	202.72
tblGrading	MaterialExported	0.00	160.00
tblLandUse	LandUseSquareFeet	0.00	16,610.00
tblLandUse	LotAcreage	0.00	0.38
tblOffRoadEquipment	LoadFactor	0.29	0.29
tblOffRoadEquipment	LoadFactor	0.38	0.38
tblOffRoadEquipment	LoadFactor	0.29	0.29
tblOffRoadEquipment	OffRoadEquipmentType		Cranes
tblOffRoadEquipment	OffRoadEquipmentType		Air Compressors
tblOffRoadEquipment	OffRoadEquipmentType		Concrete/Industrial Saws
tblOffRoadEquipment	OffRoadEquipmentType		Excavators
tblOffRoadEquipment	OffRoadEquipmentType		Plate Compactors
tblOffRoadEquipment	OffRoadEquipmentType		Air Compressors

Orange Park Acres, IRWD - Orange County, Summer

EMFAC Off-Model Adjustment Factors for Gasoline Light Duty Vehicle to Account for the SAFE Vehicle Rule Not Applied

tblOffRoadEquipment	OffRoadEquipmentType			Cranes
tblOffRoadEquipment	OffRoadEquipmentUnitAmount	1.00		0.00
tblOffRoadEquipment	OffRoadEquipmentUnitAmount	1.00		0.00
tblOffRoadEquipment	OffRoadEquipmentUnitAmount	2.00		0.00
tblOffRoadEquipment	OffRoadEquipmentUnitAmount	1.00		0.00
tblOffRoadEquipment	OffRoadEquipmentUnitAmount	1.00		0.00
tblOffRoadEquipment	OffRoadEquipmentUnitAmount	1.00		0.00
tblOffRoadEquipment	OffRoadEquipmentUnitAmount	2.00		0.00
tblOffRoadEquipment	OffRoadEquipmentUnitAmount	2.00		1.00
tblOffRoadEquipment	OffRoadEquipmentUnitAmount	1.00		0.00
tblTripsAndVMT	HaulingTripNumber	0.00		100.00
tblTripsAndVMT	HaulingTripNumber	0.00		20.00

2.0 Emissions Summary

2.1 Overall Construction (Maximum Daily Emission)

Unmitigated Construction

	ROG	NOx	CO	SO2	Fugitive PM10	Exhaust PM10	PM10 Total	Fugitive PM2.5	Exhaust PM2.5	PM2.5 Total	Bio- CO2	NBio- CO2	Total CO2	CH4	N2O	CO2e
Year	lb/day										lb/day					
2022	1.4860	12.7468	14.2385	0.0271	0.4751	0.6185	0.8338	0.0857	0.5913	0.6484	0.0000	2,587.4115	2,587.4115	0.5004	0.0214	2,603.5900
Maximum	1.4860	12.7468	14.2385	0.0271	0.4751	0.6185	0.8338	0.0857	0.5913	0.6484	0.0000	2,587.4115	2,587.4115	0.5004	0.0214	2,603.5900

Mitigated Construction

Orange Park Acres, IRWD - Orange County, Summer

EMFAC Off-Model Adjustment Factors for Gasoline Light Duty Vehicle to Account for the SAFE Vehicle Rule Not Applied

	ROG	NOx	CO	SO2	Fugitive PM10	Exhaust PM10	PM10 Total	Fugitive PM2.5	Exhaust PM2.5	PM2.5 Total	Bio- CO2	NBio- CO2	Total CO2	CH4	N2O	CO2e
Year	lb/day										lb/day					
2022	1.4860	12.7468	14.2385	0.0271	0.2576	0.6185	0.8333	0.0571	0.5913	0.6484	0.0000	2,587.4115	2,587.4115	0.5004	0.0214	2,603.5900
Maximum	1.4860	12.7468	14.2385	0.0271	0.2576	0.6185	0.8333	0.0571	0.5913	0.6484	0.0000	2,587.4115	2,587.4115	0.5004	0.0214	2,603.5900

	ROG	NOx	CO	SO2	Fugitive PM10	Exhaust PM10	PM10 Total	Fugitive PM2.5	Exhaust PM2.5	PM2.5 Total	Bio- CO2	NBio- CO2	Total CO2	CH4	N2O	CO2e
Percent Reduction	0.00	0.00	0.00	0.00	45.79	0.00	0.05	33.38	0.00	0.01	0.00	0.00	0.00	0.00	0.00	0.00

2.2 Overall Operational
Unmitigated Operational

	ROG	NOx	CO	SO2	Fugitive PM10	Exhaust PM10	PM10 Total	Fugitive PM2.5	Exhaust PM2.5	PM2.5 Total	Bio- CO2	NBio- CO2	Total CO2	CH4	N2O	CO2e
Category	lb/day										lb/day					
Area	0.3711	0.0000	1.0000e-004	0.0000		0.0000	0.0000		0.0000	0.0000		2.2000e-004	2.2000e-004	0.0000		2.3000e-004
Energy	0.0000	0.0000	0.0000	0.0000		0.0000	0.0000		0.0000	0.0000		0.0000	0.0000	0.0000	0.0000	0.0000
Mobile	0.0000	0.0000	0.0000	0.0000	0.0000	0.0000	0.0000	0.0000	0.0000	0.0000		0.0000	0.0000	0.0000	0.0000	0.0000
Total	0.3711	0.0000	1.0000e-004	0.0000	0.0000	0.0000	0.0000	0.0000	0.0000	0.0000		2.2000e-004	2.2000e-004	0.0000	0.0000	2.3000e-004

Orange Park Acres, IRWD - Orange County, Summer

EMFAC Off-Model Adjustment Factors for Gasoline Light Duty Vehicle to Account for the SAFE Vehicle Rule Not Applied

Mitigated Operational

	ROG	NOx	CO	SO2	Fugitive PM10	Exhaust PM10	PM10 Total	Fugitive PM2.5	Exhaust PM2.5	PM2.5 Total	Bio- CO2	NBio- CO2	Total CO2	CH4	N2O	CO2e
Category	lb/day										lb/day					
Area	0.3711	0.0000	1.0000e-004	0.0000		0.0000	0.0000		0.0000	0.0000		2.2000e-004	2.2000e-004	0.0000		2.3000e-004
Energy	0.0000	0.0000	0.0000	0.0000		0.0000	0.0000		0.0000	0.0000		0.0000	0.0000	0.0000	0.0000	0.0000
Mobile	0.0000	0.0000	0.0000	0.0000	0.0000	0.0000	0.0000	0.0000	0.0000	0.0000		0.0000	0.0000	0.0000	0.0000	0.0000
Total	0.3711	0.0000	1.0000e-004	0.0000	0.0000	0.0000	0.0000	0.0000	0.0000	0.0000		2.2000e-004	2.2000e-004	0.0000	0.0000	2.3000e-004

	ROG	NOx	CO	SO2	Fugitive PM10	Exhaust PM10	PM10 Total	Fugitive PM2.5	Exhaust PM2.5	PM2.5 Total	Bio- CO2	NBio-CO2	Total CO2	CH4	N2O	CO2e
Percent Reduction	0.00	0.00	0.00	0.00	0.00	0.00	0.00	0.00	0.00	0.00	0.00	0.00	0.00	0.00	0.00	0.00

3.0 Construction Detail

Construction Phase

Phase Number	Phase Name	Phase Type	Start Date	End Date	Num Days Week	Num Days	Phase Description
1	Demolition	Demolition	1/17/2022	1/29/2022	6	12	
2	Grading/Trenching	Grading	2/1/2022	3/2/2022	6	26	
3	Building Construction	Building Construction	3/3/2022	8/2/2022	6	131	
4	Paving	Paving	8/3/2022	8/16/2022	6	12	

Acres of Grading (Site Preparation Phase): 0

Orange Park Acres, IRWD - Orange County, Summer

EMFAC Off-Model Adjustment Factors for Gasoline Light Duty Vehicle to Account for the SAFE Vehicle Rule Not Applied

Acres of Grading (Grading Phase): 0

Acres of Paving: 0

Residential Indoor: 0; Residential Outdoor: 0; Non-Residential Indoor: 0; Non-Residential Outdoor: 0; Striped Parking Area: 0 (Architectural Coating –

OffRoad Equipment

Phase Name	Offroad Equipment Type	Amount	Usage Hours	Horse Power	Load Factor
Demolition	Cranes	1	8.00	231	0.29
Paving	Cement and Mortar Mixers	4	6.00	9	0.56
Demolition	Concrete/Industrial Saws	0	8.00	81	0.73
Building Construction	Cranes	0	4.00	231	0.29
Building Construction	Forklifts	0	6.00	89	0.20
Grading/Trenching	Graders	0	6.00	187	0.41
Demolition	Air Compressors	1	8.00	78	0.48
Paving	Pavers	1	7.00	130	0.42
Paving	Rollers	1	7.00	80	0.38
Demolition	Rubber Tired Dozers	0	1.00	247	0.40
Grading/Trenching	Rubber Tired Dozers	0	6.00	247	0.40
Building Construction	Tractors/Loaders/Backhoes	0	8.00	97	0.37
Demolition	Tractors/Loaders/Backhoes	1	6.00	97	0.37
Grading/Trenching	Tractors/Loaders/Backhoes	1	7.00	97	0.37
Paving	Tractors/Loaders/Backhoes	0	7.00	97	0.37
Grading/Trenching	Concrete/Industrial Saws	1	8.00	81	0.73
Grading/Trenching	Excavators	1	8.00	158	0.38
Grading/Trenching	Plate Compactors	2	8.00	8	0.43
Grading/Trenching	Air Compressors	1	8.00	78	0.48
Grading/Trenching	Cranes	1	8.00	231	0.29

Trips and VMT

Orange Park Acres, IRWD - Orange County, Summer

EMFAC Off-Model Adjustment Factors for Gasoline Light Duty Vehicle to Account for the SAFE Vehicle Rule Not Applied

Phase Name	Offroad Equipment Count	Worker Trip Number	Vendor Trip Number	Hauling Trip Number	Worker Trip Length	Vendor Trip Length	Hauling Trip Length	Worker Vehicle Class	Vendor Vehicle Class	Hauling Vehicle Class
Demolition	3	8.00	0.00	20.00	14.70	6.90	20.00	LD_Mix	HDT_Mix	HHDT
Grading/Trenching	7	18.00	0.00	20.00	14.70	6.90	20.00	LD_Mix	HDT_Mix	HHDT
Building Construction	0	7.00	3.00	100.00	14.70	6.90	20.00	LD_Mix	HDT_Mix	HHDT
Paving	6	15.00	0.00	20.00	14.70	6.90	20.00	LD_Mix	HDT_Mix	HHDT

3.1 Mitigation Measures Construction

Water Exposed Area

3.2 Demolition - 2022

Unmitigated Construction On-Site

	ROG	NOx	CO	SO2	Fugitive PM10	Exhaust PM10	PM10 Total	Fugitive PM2.5	Exhaust PM2.5	PM2.5 Total	Bio- CO2	NBio- CO2	Total CO2	CH4	N2O	CO2e
Category	lb/day										lb/day					
Fugitive Dust					0.3567	0.0000	0.3567	0.0540	0.0000	0.0540			0.0000			0.0000
Off-Road	0.7668	7.2916	5.9765	0.0120		0.3491	0.3491		0.3299	0.3299		1,156.3623	1,156.3623	0.2771		1,163.2887
Total	0.7668	7.2916	5.9765	0.0120	0.3567	0.3491	0.7058	0.0540	0.3299	0.3839		1,156.3623	1,156.3623	0.2771		1,163.2887

Unmitigated Construction Off-Site

	ROG	NOx	CO	SO2	Fugitive PM10	Exhaust PM10	PM10 Total	Fugitive PM2.5	Exhaust PM2.5	PM2.5 Total	Bio- CO2	NBio- CO2	Total CO2	CH4	N2O	CO2e
--	-----	-----	----	-----	---------------	--------------	------------	----------------	---------------	-------------	----------	-----------	-----------	-----	-----	------

Orange Park Acres, IRWD - Orange County, Summer

EMFAC Off-Model Adjustment Factors for Gasoline Light Duty Vehicle to Account for the SAFE Vehicle Rule Not Applied

Category	lb/day										lb/day					
Hauling	6.7500e-003	0.2595	0.0729	9.9000e-004	0.0291	1.9600e-003	0.0310	7.9600e-003	1.8800e-003	9.8400e-003		112.6827	112.6827	0.0107	0.0181	118.3295
Vendor	0.0000	0.0000	0.0000	0.0000	0.0000	0.0000	0.0000	0.0000	0.0000	0.0000		0.0000	0.0000	0.0000	0.0000	0.0000
Worker	0.0241	0.0162	0.2629	7.8000e-004	0.0894	4.8000e-004	0.0899	0.0237	4.4000e-004	0.0242		78.7769	78.7769	1.8500e-003	1.7700e-003	79.3508
Total	0.0308	0.2757	0.3358	1.7700e-003	0.1185	2.4400e-003	0.1209	0.0317	2.3200e-003	0.0340		191.4597	191.4597	0.0126	0.0198	197.6803

Mitigated Construction On-Site

	ROG	NOx	CO	SO2	Fugitive PM10	Exhaust PM10	PM10 Total	Fugitive PM2.5	Exhaust PM2.5	PM2.5 Total	Bio- CO2	NBio- CO2	Total CO2	CH4	N2O	CO2e
Category	lb/day										lb/day					
Fugitive Dust					0.1391	0.0000	0.1391	0.0211	0.0000	0.0211			0.0000			0.0000
Off-Road	0.7668	7.2916	5.9765	0.0120		0.3491	0.3491		0.3299	0.3299	0.0000	1,156.3623	1,156.3623	0.2771		1,163.2887
Total	0.7668	7.2916	5.9765	0.0120	0.1391	0.3491	0.4882	0.0211	0.3299	0.3510	0.0000	1,156.3623	1,156.3623	0.2771		1,163.2887

Mitigated Construction Off-Site

	ROG	NOx	CO	SO2	Fugitive PM10	Exhaust PM10	PM10 Total	Fugitive PM2.5	Exhaust PM2.5	PM2.5 Total	Bio- CO2	NBio- CO2	Total CO2	CH4	N2O	CO2e
--	-----	-----	----	-----	---------------	--------------	------------	----------------	---------------	-------------	----------	-----------	-----------	-----	-----	------

Orange Park Acres, IRWD - Orange County, Summer

EMFAC Off-Model Adjustment Factors for Gasoline Light Duty Vehicle to Account for the SAFE Vehicle Rule Not Applied

Category	lb/day										lb/day					
Hauling	6.7500e-003	0.2595	0.0729	9.9000e-004	0.0291	1.9600e-003	0.0310	7.9600e-003	1.8800e-003	9.8400e-003		112.6827	112.6827	0.0107	0.0181	118.3295
Vendor	0.0000	0.0000	0.0000	0.0000	0.0000	0.0000	0.0000	0.0000	0.0000	0.0000		0.0000	0.0000	0.0000	0.0000	0.0000
Worker	0.0241	0.0162	0.2629	7.8000e-004	0.0894	4.8000e-004	0.0899	0.0237	4.4000e-004	0.0242		78.7769	78.7769	1.8500e-003	1.7700e-003	79.3508
Total	0.0308	0.2757	0.3358	1.7700e-003	0.1185	2.4400e-003	0.1209	0.0317	2.3200e-003	0.0340		191.4597	191.4597	0.0126	0.0198	197.6803

3.3 Grading/Trenching - 2022

Unmitigated Construction On-Site

	ROG	NOx	CO	SO2	Fugitive PM10	Exhaust PM10	PM10 Total	Fugitive PM2.5	Exhaust PM2.5	PM2.5 Total	Bio- CO2	NBio- CO2	Total CO2	CH4	N2O	CO2e
Category	lb/day										lb/day					
Fugitive Dust					7.0000e-004	0.0000	7.0000e-004	1.1000e-004	0.0000	1.1000e-004			0.0000			0.0000
Off-Road	1.4287	12.5906	13.6133	0.0248		0.6165	0.6165		0.5894	0.5894		2,358.1560	2,358.1560	0.4913		2,370.4371
Total	1.4287	12.5906	13.6133	0.0248	7.0000e-004	0.6165	0.6172	1.1000e-004	0.5894	0.5895		2,358.1560	2,358.1560	0.4913		2,370.4371

Unmitigated Construction Off-Site

	ROG	NOx	CO	SO2	Fugitive PM10	Exhaust PM10	PM10 Total	Fugitive PM2.5	Exhaust PM2.5	PM2.5 Total	Bio- CO2	NBio- CO2	Total CO2	CH4	N2O	CO2e
--	-----	-----	----	-----	---------------	--------------	------------	----------------	---------------	-------------	----------	-----------	-----------	-----	-----	------

Orange Park Acres, IRWD - Orange County, Summer

EMFAC Off-Model Adjustment Factors for Gasoline Light Duty Vehicle to Account for the SAFE Vehicle Rule Not Applied

Category	lb/day										lb/day					
Hauling	3.1200e-003	0.1198	0.0336	4.6000e-004	0.0134	9.1000e-004	0.0143	3.6700e-003	8.7000e-004	4.5400e-003		52.0074	52.0074	4.9600e-003	8.3300e-003	54.6136
Vendor	0.0000	0.0000	0.0000	0.0000	0.0000	0.0000	0.0000	0.0000	0.0000	0.0000		0.0000	0.0000	0.0000	0.0000	0.0000
Worker	0.0541	0.0364	0.5915	1.7500e-003	0.2012	1.0800e-003	0.2023	0.0534	1.0000e-003	0.0544		177.2481	177.2481	4.1700e-003	3.9800e-003	178.5393
Total	0.0573	0.1561	0.6252	2.2100e-003	0.2146	1.9900e-003	0.2166	0.0570	1.8700e-003	0.0589		229.2555	229.2555	9.1300e-003	0.0123	233.1529

Mitigated Construction On-Site

	ROG	NOx	CO	SO2	Fugitive PM10	Exhaust PM10	PM10 Total	Fugitive PM2.5	Exhaust PM2.5	PM2.5 Total	Bio- CO2	NBio- CO2	Total CO2	CH4	N2O	CO2e
Category	lb/day										lb/day					
Fugitive Dust					2.7000e-004	0.0000	2.7000e-004	4.0000e-005	0.0000	4.0000e-005			0.0000			0.0000
Off-Road	1.4287	12.5906	13.6133	0.0248		0.6165	0.6165		0.5894	0.5894	0.0000	2,358.1560	2,358.1560	0.4913		2,370.4371
Total	1.4287	12.5906	13.6133	0.0248	2.7000e-004	0.6165	0.6167	4.0000e-005	0.5894	0.5895	0.0000	2,358.1560	2,358.1560	0.4913		2,370.4371

Mitigated Construction Off-Site

	ROG	NOx	CO	SO2	Fugitive PM10	Exhaust PM10	PM10 Total	Fugitive PM2.5	Exhaust PM2.5	PM2.5 Total	Bio- CO2	NBio- CO2	Total CO2	CH4	N2O	CO2e
--	-----	-----	----	-----	---------------	--------------	------------	----------------	---------------	-------------	----------	-----------	-----------	-----	-----	------

Orange Park Acres, IRWD - Orange County, Summer

EMFAC Off-Model Adjustment Factors for Gasoline Light Duty Vehicle to Account for the SAFE Vehicle Rule Not Applied

Category	lb/day										lb/day					
Hauling	3.1200e-003	0.1198	0.0336	4.6000e-004	0.0134	9.1000e-004	0.0143	3.6700e-003	8.7000e-004	4.5400e-003		52.0074	52.0074	4.9600e-003	8.3300e-003	54.6136
Vendor	0.0000	0.0000	0.0000	0.0000	0.0000	0.0000	0.0000	0.0000	0.0000	0.0000		0.0000	0.0000	0.0000	0.0000	0.0000
Worker	0.0541	0.0364	0.5915	1.7500e-003	0.2012	1.0800e-003	0.2023	0.0534	1.0000e-003	0.0544		177.2481	177.2481	4.1700e-003	3.9800e-003	178.5393
Total	0.0573	0.1561	0.6252	2.2100e-003	0.2146	1.9900e-003	0.2166	0.0570	1.8700e-003	0.0589		229.2555	229.2555	9.1300e-003	0.0123	233.1529

3.4 Building Construction - 2022

Unmitigated Construction On-Site

	ROG	NOx	CO	SO2	Fugitive PM10	Exhaust PM10	PM10 Total	Fugitive PM2.5	Exhaust PM2.5	PM2.5 Total	Bio- CO2	NBio- CO2	Total CO2	CH4	N2O	CO2e
Category	lb/day										lb/day					
Off-Road	0.0000	0.0000	0.0000	0.0000		0.0000	0.0000		0.0000	0.0000		0.0000	0.0000	0.0000		0.0000
Total	0.0000	0.0000	0.0000	0.0000		0.0000	0.0000		0.0000	0.0000		0.0000	0.0000	0.0000		0.0000

Unmitigated Construction Off-Site

	ROG	NOx	CO	SO2	Fugitive PM10	Exhaust PM10	PM10 Total	Fugitive PM2.5	Exhaust PM2.5	PM2.5 Total	Bio- CO2	NBio- CO2	Total CO2	CH4	N2O	CO2e
Category	lb/day										lb/day					

Orange Park Acres, IRWD - Orange County, Summer

EMFAC Off-Model Adjustment Factors for Gasoline Light Duty Vehicle to Account for the SAFE Vehicle Rule Not Applied

Hauling	3.0900e-003	0.1189	0.0334	4.6000e-004	0.0133	9.0000e-004	0.0142	3.6500e-003	8.6000e-004	4.5100e-003		51.6104	51.6104	4.9200e-003	8.2700e-003	54.1967
Vendor	4.9900e-003	0.1346	0.0478	5.7000e-004	0.0192	1.3100e-003	0.0205	5.5200e-003	1.2500e-003	6.7700e-003		62.2073	62.2073	3.5600e-003	8.9100e-003	64.9530
Worker	0.0211	0.0142	0.2300	6.8000e-004	0.0782	4.2000e-004	0.0787	0.0208	3.9000e-004	0.0211		68.9298	68.9298	1.6200e-003	1.5500e-003	69.4320
Total	0.0291	0.2676	0.3112	1.7100e-003	0.1107	2.6300e-003	0.1134	0.0299	2.5000e-003	0.0324		182.7475	182.7475	0.0101	0.0187	188.5817

Mitigated Construction On-Site

	ROG	NOx	CO	SO2	Fugitive PM10	Exhaust PM10	PM10 Total	Fugitive PM2.5	Exhaust PM2.5	PM2.5 Total	Bio- CO2	NBio- CO2	Total CO2	CH4	N2O	CO2e
Category	lb/day										lb/day					
Off-Road	0.0000	0.0000	0.0000	0.0000		0.0000	0.0000		0.0000	0.0000	0.0000	0.0000	0.0000	0.0000		0.0000
Total	0.0000	0.0000	0.0000	0.0000		0.0000	0.0000		0.0000	0.0000	0.0000	0.0000	0.0000	0.0000		0.0000

Mitigated Construction Off-Site

	ROG	NOx	CO	SO2	Fugitive PM10	Exhaust PM10	PM10 Total	Fugitive PM2.5	Exhaust PM2.5	PM2.5 Total	Bio- CO2	NBio- CO2	Total CO2	CH4	N2O	CO2e
Category	lb/day										lb/day					
Hauling	3.0900e-003	0.1189	0.0334	4.6000e-004	0.0133	9.0000e-004	0.0142	3.6500e-003	8.6000e-004	4.5100e-003		51.6104	51.6104	4.9200e-003	8.2700e-003	54.1967

Orange Park Acres, IRWD - Orange County, Summer

EMFAC Off-Model Adjustment Factors for Gasoline Light Duty Vehicle to Account for the SAFE Vehicle Rule Not Applied

Vendor	4.9900e-003	0.1346	0.0478	5.7000e-004	0.0192	1.3100e-003	0.0205	5.5200e-003	1.2500e-003	6.7700e-003		62.2073	62.2073	3.5600e-003	8.9100e-003	64.9530
Worker	0.0211	0.0142	0.2300	6.8000e-004	0.0782	4.2000e-004	0.0787	0.0208	3.9000e-004	0.0211		68.9298	68.9298	1.6200e-003	1.5500e-003	69.4320
Total	0.0291	0.2676	0.3112	1.7100e-003	0.1107	2.6300e-003	0.1134	0.0299	2.5000e-003	0.0324		182.7475	182.7475	0.0101	0.0187	188.5817

3.5 Paving - 2022

Unmitigated Construction On-Site

	ROG	NOx	CO	SO2	Fugitive PM10	Exhaust PM10	PM10 Total	Fugitive PM2.5	Exhaust PM2.5	PM2.5 Total	Bio- CO2	NBio- CO2	Total CO2	CH4	N2O	CO2e
Category	lb/day										lb/day					
Off-Road	0.5028	4.4512	5.0766	8.5400e-003		0.2172	0.2172		0.2033	0.2033		772.2405	772.2405	0.2165		777.6524
Paving	0.0000					0.0000	0.0000		0.0000	0.0000			0.0000			0.0000
Total	0.5028	4.4512	5.0766	8.5400e-003		0.2172	0.2172		0.2033	0.2033		772.2405	772.2405	0.2165		777.6524

Unmitigated Construction Off-Site

	ROG	NOx	CO	SO2	Fugitive PM10	Exhaust PM10	PM10 Total	Fugitive PM2.5	Exhaust PM2.5	PM2.5 Total	Bio- CO2	NBio- CO2	Total CO2	CH4	N2O	CO2e
Category	lb/day										lb/day					
Hauling	6.7500e-003	0.2595	0.0729	9.9000e-004	0.0291	1.9600e-003	0.0310	7.9600e-003	1.8800e-003	9.8400e-003		112.6827	112.6827	0.0107	0.0181	118.3295

Orange Park Acres, IRWD - Orange County, Summer

EMFAC Off-Model Adjustment Factors for Gasoline Light Duty Vehicle to Account for the SAFE Vehicle Rule Not Applied

Vendor	0.0000	0.0000	0.0000	0.0000	0.0000	0.0000	0.0000	0.0000	0.0000	0.0000	0.0000	0.0000	0.0000	0.0000	0.0000	0.0000
Worker	0.0451	0.0303	0.4930	1.4600e-003	0.1677	9.0000e-004	0.1686	0.0445	8.3000e-004	0.0453		147.7067	147.7067	3.4700e-003	3.3200e-003	148.7828
Total	0.0519	0.2898	0.5658	2.4500e-003	0.1967	2.8600e-003	0.1996	0.0524	2.7100e-003	0.0551		260.3895	260.3895	0.0142	0.0214	267.1122

Mitigated Construction On-Site

	ROG	NOx	CO	SO2	Fugitive PM10	Exhaust PM10	PM10 Total	Fugitive PM2.5	Exhaust PM2.5	PM2.5 Total	Bio- CO2	NBio- CO2	Total CO2	CH4	N2O	CO2e
Category	lb/day										lb/day					
Off-Road	0.5028	4.4512	5.0766	8.5400e-003		0.2172	0.2172		0.2033	0.2033	0.0000	772.2405	772.2405	0.2165		777.6524
Paving	0.0000					0.0000	0.0000		0.0000	0.0000			0.0000			0.0000
Total	0.5028	4.4512	5.0766	8.5400e-003		0.2172	0.2172		0.2033	0.2033	0.0000	772.2405	772.2405	0.2165		777.6524

Mitigated Construction Off-Site

	ROG	NOx	CO	SO2	Fugitive PM10	Exhaust PM10	PM10 Total	Fugitive PM2.5	Exhaust PM2.5	PM2.5 Total	Bio- CO2	NBio- CO2	Total CO2	CH4	N2O	CO2e
Category	lb/day										lb/day					
Hauling	6.7500e-003	0.2595	0.0729	9.9000e-004	0.0291	1.9600e-003	0.0310	7.9600e-003	1.8800e-003	9.8400e-003		112.6827	112.6827	0.0107	0.0181	118.3295

Orange Park Acres, IRWD - Orange County, Summer

EMFAC Off-Model Adjustment Factors for Gasoline Light Duty Vehicle to Account for the SAFE Vehicle Rule Not Applied

Vendor	0.0000	0.0000	0.0000	0.0000	0.0000	0.0000	0.0000	0.0000	0.0000	0.0000	0.0000	0.0000	0.0000	0.0000	0.0000	0.0000
Worker	0.0451	0.0303	0.4930	1.4600e-003	0.1677	9.0000e-004	0.1686	0.0445	8.3000e-004	0.0453		147.7067	147.7067	3.4700e-003	3.3200e-003	148.7828
Total	0.0519	0.2898	0.5658	2.4500e-003	0.1967	2.8600e-003	0.1996	0.0524	2.7100e-003	0.0551		260.3895	260.3895	0.0142	0.0214	267.1122

4.0 Operational Detail - Mobile

4.1 Mitigation Measures Mobile

	ROG	NOx	CO	SO2	Fugitive PM10	Exhaust PM10	PM10 Total	Fugitive PM2.5	Exhaust PM2.5	PM2.5 Total	Bio- CO2	NBio- CO2	Total CO2	CH4	N2O	CO2e
Category	lb/day										lb/day					
Mitigated	0.0000	0.0000	0.0000	0.0000	0.0000	0.0000	0.0000	0.0000	0.0000	0.0000		0.0000	0.0000	0.0000	0.0000	0.0000
Unmitigated	0.0000	0.0000	0.0000	0.0000	0.0000	0.0000	0.0000	0.0000	0.0000	0.0000		0.0000	0.0000	0.0000	0.0000	0.0000

4.2 Trip Summary Information

Land Use	Average Daily Trip Rate			Unmitigated	Mitigated
	Weekday	Saturday	Sunday	Annual VMT	Annual VMT
User Defined Industrial	0.00	0.00	0.00		
Total	0.00	0.00	0.00		

4.3 Trip Type Information

	Miles	Trip %	Trip Purpose %
--	-------	--------	----------------

Orange Park Acres, IRWD - Orange County, Summer

EMFAC Off-Model Adjustment Factors for Gasoline Light Duty Vehicle to Account for the SAFE Vehicle Rule Not Applied

Land Use	H-W or C-W	H-S or C-C	H-O or C-NW	H-W or C-W	H-S or C-C	H-O or C-NW	Primary	Diverted	Pass-by
User Defined Industrial	16.60	8.40	6.90	0.00	0.00	0.00	0	0	0

4.4 Fleet Mix

Land Use	LDA	LDT1	LDT2	MDV	LHD1	LHD2	MHD	HHD	OBUS	UBUS	MCY	SBUS	MH
User Defined Industrial	0.542853	0.058126	0.187899	0.130925	0.024443	0.006426	0.014590	0.004841	0.000666	0.000390	0.024092	0.000735	0.00401

5.0 Energy Detail

Historical Energy Use: N

5.1 Mitigation Measures Energy

	ROG	NOx	CO	SO2	Fugitive PM10	Exhaust PM10	PM10 Total	Fugitive PM2.5	Exhaust PM2.5	PM2.5 Total	Bio- CO2	NBio- CO2	Total CO2	CH4	N2O	CO2e
Category	lb/day										lb/day					
NaturalGas Mitigated	0.0000	0.0000	0.0000	0.0000		0.0000	0.0000		0.0000	0.0000		0.0000	0.0000	0.0000	0.0000	0.0000
NaturalGas Unmitigated	0.0000	0.0000	0.0000	0.0000		0.0000	0.0000		0.0000	0.0000		0.0000	0.0000	0.0000	0.0000	0.0000

5.2 Energy by Land Use - NaturalGas

Unmitigated

NaturalGas Use	ROG	NOx	CO	SO2	Fugitive PM10	Exhaust PM10	PM10 Total	Fugitive PM2.5	Exhaust PM2.5	PM2.5 Total	Bio- CO2	NBio- CO2	Total CO2	CH4	N2O	CO2e
----------------	-----	-----	----	-----	---------------	--------------	------------	----------------	---------------	-------------	----------	-----------	-----------	-----	-----	------

Orange Park Acres, IRWD - Orange County, Summer

EMFAC Off-Model Adjustment Factors for Gasoline Light Duty Vehicle to Account for the SAFE Vehicle Rule Not Applied

Land Use	kBTU/yr	lb/day										lb/day					
User Defined Industrial	0	0.0000	0.0000	0.0000	0.0000		0.0000	0.0000		0.0000	0.0000		0.0000	0.0000	0.0000	0.0000	0.0000
Total		0.0000	0.0000	0.0000	0.0000		0.0000	0.0000		0.0000	0.0000		0.0000	0.0000	0.0000	0.0000	0.0000

Mitigated

	Natural Gas Use	ROG	NOx	CO	SO2	Fugitive PM10	Exhaust PM10	PM10 Total	Fugitive PM2.5	Exhaust PM2.5	PM2.5 Total	Bio- CO2	NBio- CO2	Total CO2	CH4	N2O	CO2e
Land Use	kBTU/yr	lb/day										lb/day					
User Defined Industrial	0	0.0000	0.0000	0.0000	0.0000		0.0000	0.0000		0.0000	0.0000		0.0000	0.0000	0.0000	0.0000	0.0000
Total		0.0000	0.0000	0.0000	0.0000		0.0000	0.0000		0.0000	0.0000		0.0000	0.0000	0.0000	0.0000	0.0000

6.0 Area Detail

6.1 Mitigation Measures Area

ROG	NOx	CO	SO2	Fugitive PM10	Exhaust PM10	PM10 Total	Fugitive PM2.5	Exhaust PM2.5	PM2.5 Total	Bio- CO2	NBio- CO2	Total CO2	CH4	N2O	CO2e
-----	-----	----	-----	---------------	--------------	------------	----------------	---------------	-------------	----------	-----------	-----------	-----	-----	------

Orange Park Acres, IRWD - Orange County, Summer

EMFAC Off-Model Adjustment Factors for Gasoline Light Duty Vehicle to Account for the SAFE Vehicle Rule Not Applied

Category	lb/day										lb/day				
Mitigated	0.3711	0.0000	1.0000e-004	0.0000		0.0000	0.0000		0.0000	0.0000	2.2000e-004	2.2000e-004	0.0000		2.3000e-004
Unmitigated	0.3711	0.0000	1.0000e-004	0.0000		0.0000	0.0000		0.0000	0.0000	2.2000e-004	2.2000e-004	0.0000		2.3000e-004

6.2 Area by SubCategory

Unmitigated

	ROG	NOx	CO	SO2	Fugitive PM10	Exhaust PM10	PM10 Total	Fugitive PM2.5	Exhaust PM2.5	PM2.5 Total	Bio- CO2	NBio- CO2	Total CO2	CH4	N2O	CO2e
SubCategory	lb/day										lb/day					
Architectural Coating	0.0422					0.0000	0.0000		0.0000	0.0000			0.0000			0.0000
Consumer Products	0.3289					0.0000	0.0000		0.0000	0.0000			0.0000			0.0000
Landscaping	1.0000e-005	0.0000	1.0000e-004	0.0000		0.0000	0.0000		0.0000	0.0000		2.2000e-004	2.2000e-004	0.0000		2.3000e-004
Total	0.3711	0.0000	1.0000e-004	0.0000		0.0000	0.0000		0.0000	0.0000		2.2000e-004	2.2000e-004	0.0000		2.3000e-004

Mitigated

	ROG	NOx	CO	SO2	Fugitive PM10	Exhaust PM10	PM10 Total	Fugitive PM2.5	Exhaust PM2.5	PM2.5 Total	Bio- CO2	NBio- CO2	Total CO2	CH4	N2O	CO2e
SubCategory	lb/day										lb/day					

Orange Park Acres, IRWD - Orange County, Summer

EMFAC Off-Model Adjustment Factors for Gasoline Light Duty Vehicle to Account for the SAFE Vehicle Rule Not Applied

Architectural Coating	0.0422				0.0000	0.0000		0.0000	0.0000			0.0000		0.0000
Consumer Products	0.3289				0.0000	0.0000		0.0000	0.0000			0.0000		0.0000
Landscaping	1.0000e-005	0.0000	1.0000e-004	0.0000	0.0000	0.0000		0.0000	0.0000		2.2000e-004	2.2000e-004	0.0000	2.3000e-004
Total	0.3711	0.0000	1.0000e-004	0.0000	0.0000	0.0000		0.0000	0.0000		2.2000e-004	2.2000e-004	0.0000	2.3000e-004

7.0 Water Detail

7.1 Mitigation Measures Water

8.0 Waste Detail

8.1 Mitigation Measures Waste

9.0 Operational Offroad

Equipment Type	Number	Hours/Day	Days/Year	Horse Power	Load Factor	Fuel Type
----------------	--------	-----------	-----------	-------------	-------------	-----------

10.0 Stationary Equipment

Fire Pumps and Emergency Generators

Equipment Type	Number	Hours/Day	Hours/Year	Horse Power	Load Factor	Fuel Type
----------------	--------	-----------	------------	-------------	-------------	-----------

Boilers

Equipment Type	Number	Heat Input/Day	Heat Input/Year	Boiler Rating	Fuel Type
----------------	--------	----------------	-----------------	---------------	-----------

User Defined Equipment

Equipment Type	Number
----------------	--------

Orange Park Acres, IRWD - Orange County, Summer

EMFAC Off-Model Adjustment Factors for Gasoline Light Duty Vehicle to Account for the SAFE Vehicle Rule Not Applied

11.0 Vegetation

OffRoad Equipment

Phase Narr Offroad Eq Amount

Demolition Cranes	1
Paving Cement and	4
Demolition Concrete/	0
Building Concrete Cranes	0
Building Concrete Forklifts	0
Grading/Tr Graders	0
Demolition Air Compressor	1
Paving Pavers	1
Paving Rollers	1
Demolition Rubber Tires	0
Grading/Tr Rubber Tires	0
Building Concrete Tractors/Loader	0
Demolition Tractors/Loader	1
Grading/Tr Tractors/Loader	1
Paving Tractors/Loader	0
Grading/Tr Concrete/	1
Grading/Tr Excavators	1
Grading/Tr Plate Compactor	2
Grading/Tr Air Compressor	1
Grading/Tr Cranes	1

Orange Park Acres, IRWD - Orange County, Annual

EMFAC Off-Model Adjustment Factors for Gasoline Light Duty Vehicle to Account for the SAFE Vehicle Rule Not Applied

**Orange Park Acres, IRWD
Orange County, Annual**

1.0 Project Characteristics

1.1 Land Usage

Land Uses	Size	Metric	Lot Acreage	Floor Surface Area	Population
User Defined Industrial	1.00	User Defined Unit	0.38	16,610.00	0

1.2 Other Project Characteristics

Urbanization	Urban	Wind Speed (m/s)	2.2	Precipitation Freq (Days)	30
Climate Zone	8			Operational Year	2022
Utility Company	Southern California Edison				
CO2 Intensity (lb/MWhr)	390.98	CH4 Intensity (lb/MWhr)	0.033	N2O Intensity (lb/MWhr)	0.004

1.3 User Entered Comments & Non-Default Data

- Project Characteristics -
- Land Use - Estimated lot acreage
- Construction Phase - .
- Off-road Equipment - .
- Off-road Equipment - .
- Off-road Equipment - No building construction, minor modifications inside building and install of outdoor equipment.
- Off-road Equipment - .
- Grading - .
- Demolition - .
- Trips and VMT - .
- Energy Use - no natural gas required
- Construction Off-road Equipment Mitigation -

Orange Park Acres, IRWD - Orange County, Annual

EMFAC Off-Model Adjustment Factors for Gasoline Light Duty Vehicle to Account for the SAFE Vehicle Rule Not Applied

Table Name	Column Name	Default Value	New Value
tblConstructionPhase	NumDays	100.00	131.00
tblConstructionPhase	NumDays	10.00	12.00
tblConstructionPhase	NumDays	2.00	26.00
tblConstructionPhase	NumDays	5.00	12.00
tblConstructionPhase	NumDaysWeek	5.00	6.00
tblConstructionPhase	NumDaysWeek	5.00	6.00
tblConstructionPhase	NumDaysWeek	5.00	6.00
tblConstructionPhase	NumDaysWeek	5.00	6.00
tblConstructionPhase	PhaseEndDate	6/22/2022	8/2/2022
tblConstructionPhase	PhaseEndDate	1/28/2022	1/29/2022
tblConstructionPhase	PhaseEndDate	2/2/2022	3/2/2022
tblConstructionPhase	PhaseEndDate	6/29/2022	8/16/2022
tblConstructionPhase	PhaseStartDate	2/3/2022	3/3/2022
tblConstructionPhase	PhaseStartDate	6/23/2022	8/3/2022
tblEnergyUse	NT24E	0.00	267.03
tblGrading	MaterialExported	0.00	160.00
tblLandUse	LandUseSquareFeet	0.00	16,610.00
tblLandUse	LotAcreage	0.00	0.38
tblOffRoadEquipment	LoadFactor	0.29	0.29
tblOffRoadEquipment	LoadFactor	0.38	0.38
tblOffRoadEquipment	LoadFactor	0.29	0.29
tblOffRoadEquipment	OffRoadEquipmentType		Cranes
tblOffRoadEquipment	OffRoadEquipmentType		Air Compressors
tblOffRoadEquipment	OffRoadEquipmentType		Concrete/Industrial Saws
tblOffRoadEquipment	OffRoadEquipmentType		Excavators
tblOffRoadEquipment	OffRoadEquipmentType		Plate Compactors
tblOffRoadEquipment	OffRoadEquipmentType		Air Compressors

Orange Park Acres, IRWD - Orange County, Annual

EMFAC Off-Model Adjustment Factors for Gasoline Light Duty Vehicle to Account for the SAFE Vehicle Rule Not Applied

tblOffRoadEquipment	OffRoadEquipmentType			Cranes
tblOffRoadEquipment	OffRoadEquipmentUnitAmount	1.00		0.00
tblOffRoadEquipment	OffRoadEquipmentUnitAmount	1.00		0.00
tblOffRoadEquipment	OffRoadEquipmentUnitAmount	2.00		0.00
tblOffRoadEquipment	OffRoadEquipmentUnitAmount	1.00		0.00
tblOffRoadEquipment	OffRoadEquipmentUnitAmount	1.00		0.00
tblOffRoadEquipment	OffRoadEquipmentUnitAmount	1.00		0.00
tblOffRoadEquipment	OffRoadEquipmentUnitAmount	2.00		0.00
tblOffRoadEquipment	OffRoadEquipmentUnitAmount	2.00		1.00
tblOffRoadEquipment	OffRoadEquipmentUnitAmount	1.00		0.00
tblTripsAndVMT	HaulingTripNumber	0.00		100.00
tblTripsAndVMT	HaulingTripNumber	0.00		20.00

2.0 Emissions Summary

2.1 Overall Construction

Unmitigated Construction

	ROG	NOx	CO	SO2	Fugitive PM10	Exhaust PM10	PM10 Total	Fugitive PM2.5	Exhaust PM2.5	PM2.5 Total	Bio- CO2	NBio- CO2	Total CO2	CH4	N2O	CO2e
Year	tons/yr										MT/yr					
2022	0.0293	0.2584	0.2760	6.1000e-004	0.0139	0.0116	0.0255	3.4800e-003	0.0111	0.0146	0.0000	54.0717	54.0717	9.3400e-003	1.5000e-003	54.7510
Maximum	0.0293	0.2584	0.2760	6.1000e-004	0.0139	0.0116	0.0255	3.4800e-003	0.0111	0.0146	0.0000	54.0717	54.0717	9.3400e-003	1.5000e-003	54.7510

Mitigated Construction

Orange Park Acres, IRWD - Orange County, Annual

EMFAC Off-Model Adjustment Factors for Gasoline Light Duty Vehicle to Account for the SAFE Vehicle Rule Not Applied

	ROG	NOx	CO	SO2	Fugitive PM10	Exhaust PM10	PM10 Total	Fugitive PM2.5	Exhaust PM2.5	PM2.5 Total	Bio- CO2	NBio- CO2	Total CO2	CH4	N2O	CO2e
Year	tons/yr										MT/yr					
2022	0.0293	0.2584	0.2760	6.1000e-004	0.0126	0.0116	0.0242	3.2800e-003	0.0111	0.0144	0.0000	54.0716	54.0716	9.3400e-003	1.5000e-003	54.7509
Maximum	0.0293	0.2584	0.2760	6.1000e-004	0.0126	0.0116	0.0242	3.2800e-003	0.0111	0.0144	0.0000	54.0716	54.0716	9.3400e-003	1.5000e-003	54.7509

	ROG	NOx	CO	SO2	Fugitive PM10	Exhaust PM10	PM10 Total	Fugitive PM2.5	Exhaust PM2.5	PM2.5 Total	Bio- CO2	NBio-CO2	Total CO2	CH4	N2O	CO2e
Percent Reduction	0.00	0.00	0.00	0.00	9.44	0.00	5.13	5.75	0.00	1.37	0.00	0.00	0.00	0.00	0.00	0.00

Quarter	Start Date	End Date	Maximum Unmitigated ROG + NOX (tons/quarter)	Maximum Mitigated ROG + NOX (tons/quarter)
1	1-17-2022	4-16-2022	0.2357	0.2357
2	4-17-2022	7-16-2022	0.0116	0.0116
3	7-17-2022	9-30-2022	0.0339	0.0339
		Highest	0.2357	0.2357

2.2 Overall Operational

Unmitigated Operational

	ROG	NOx	CO	SO2	Fugitive PM10	Exhaust PM10	PM10 Total	Fugitive PM2.5	Exhaust PM2.5	PM2.5 Total	Bio- CO2	NBio- CO2	Total CO2	CH4	N2O	CO2e
Category	tons/yr										MT/yr					
Area	0.0677	0.0000	1.0000e-005	0.0000		0.0000	0.0000		0.0000	0.0000	0.0000	2.0000e-005	2.0000e-005	0.0000	0.0000	3.0000e-005

Orange Park Acres, IRWD - Orange County, Annual

EMFAC Off-Model Adjustment Factors for Gasoline Light Duty Vehicle to Account for the SAFE Vehicle Rule Not Applied

3.0 Construction Detail

Construction Phase

Phase Number	Phase Name	Phase Type	Start Date	End Date	Num Days Week	Num Days	Phase Description
1	Demolition	Demolition	1/17/2022	1/29/2022	6	12	
2	Grading/Trenching	Grading	2/1/2022	3/2/2022	6	26	
3	Building Construction	Building Construction	3/3/2022	8/2/2022	6	131	
4	Paving	Paving	8/3/2022	8/16/2022	6	12	

Acres of Grading (Site Preparation Phase): 0

Acres of Grading (Grading Phase): 0

Acres of Paving: 0

Residential Indoor: 0; Residential Outdoor: 0; Non-Residential Indoor: 0; Non-Residential Outdoor: 0; Striped Parking Area: 0 (Architectural Coating –

OffRoad Equipment

Phase Name	Offroad Equipment Type	Amount	Usage Hours	Horse Power	Load Factor
Demolition	Cranes	1	8.00	231	0.29
Paving	Cement and Mortar Mixers	4	6.00	9	0.56
Demolition	Concrete/Industrial Saws	0	8.00	81	0.73
Building Construction	Cranes	0	4.00	231	0.29
Building Construction	Forklifts	0	6.00	89	0.20
Grading/Trenching	Graders	0	6.00	187	0.41
Demolition	Air Compressors	1	8.00	78	0.48
Paving	Pavers	1	7.00	130	0.42
Paving	Rollers	1	7.00	80	0.38
Demolition	Rubber Tired Dozers	0	1.00	247	0.40
Grading/Trenching	Rubber Tired Dozers	0	6.00	247	0.40

Orange Park Acres, IRWD - Orange County, Annual

EMFAC Off-Model Adjustment Factors for Gasoline Light Duty Vehicle to Account for the SAFE Vehicle Rule Not Applied

Building Construction	Tractors/Loaders/Backhoes	0	8.00	97	0.37
Demolition	Tractors/Loaders/Backhoes	1	6.00	97	0.37
Grading/Trenching	Tractors/Loaders/Backhoes	1	7.00	97	0.37
Paving	Tractors/Loaders/Backhoes	0	7.00	97	0.37
Grading/Trenching	Concrete/Industrial Saws	1	8.00	81	0.73
Grading/Trenching	Excavators	1	8.00	158	0.38
Grading/Trenching	Plate Compactors	2	8.00	8	0.43
Grading/Trenching	Air Compressors	1	8.00	78	0.48
Grading/Trenching	Cranes	1	8.00	231	0.29

Trips and VMT

Phase Name	Offroad Equipment Count	Worker Trip Number	Vendor Trip Number	Hauling Trip Number	Worker Trip Length	Vendor Trip Length	Hauling Trip Length	Worker Vehicle Class	Vendor Vehicle Class	Hauling Vehicle Class
Demolition	3	8.00	0.00	20.00	14.70	6.90	20.00	LD_Mix	HDT_Mix	HHDT
Grading/Trenching	7	18.00	0.00	20.00	14.70	6.90	20.00	LD_Mix	HDT_Mix	HHDT
Building Construction	0	7.00	3.00	100.00	14.70	6.90	20.00	LD_Mix	HDT_Mix	HHDT
Paving	6	15.00	0.00	20.00	14.70	6.90	20.00	LD_Mix	HDT_Mix	HHDT

3.1 Mitigation Measures Construction

Water Exposed Area

3.2 Demolition - 2022

Unmitigated Construction On-Site

Category	ROG	NOx	CO	SO2	Fugitive PM10	Exhaust PM10	PM10 Total	Fugitive PM2.5	Exhaust PM2.5	PM2.5 Total	Bio- CO2	NBio- CO2	Total CO2	CH4	N2O	CO2e
	tons/yr										MT/yr					

Orange Park Acres, IRWD - Orange County, Annual

EMFAC Off-Model Adjustment Factors for Gasoline Light Duty Vehicle to Account for the SAFE Vehicle Rule Not Applied

Fugitive Dust					2.1400e-003	0.0000	2.1400e-003	3.2000e-004	0.0000	3.2000e-004	0.0000	0.0000	0.0000	0.0000	0.0000	0.0000
Off-Road	4.6000e-003	0.0438	0.0359	7.0000e-005		2.0900e-003	2.0900e-003		1.9800e-003	1.9800e-003	0.0000	6.2942	6.2942	1.5100e-003	0.0000	6.3319
Total	4.6000e-003	0.0438	0.0359	7.0000e-005	2.1400e-003	2.0900e-003	4.2300e-003	3.2000e-004	1.9800e-003	2.3000e-003	0.0000	6.2942	6.2942	1.5100e-003	0.0000	6.3319

Unmitigated Construction Off-Site

	ROG	NOx	CO	SO2	Fugitive PM10	Exhaust PM10	PM10 Total	Fugitive PM2.5	Exhaust PM2.5	PM2.5 Total	Bio- CO2	NBio- CO2	Total CO2	CH4	N2O	CO2e
Category	tons/yr										MT/yr					
Hauling	4.0000e-005	1.6400e-003	4.4000e-004	1.0000e-005	1.7000e-004	1.0000e-005	1.8000e-004	5.0000e-005	1.0000e-005	6.0000e-005	0.0000	0.6134	0.6134	6.0000e-005	1.0000e-004	0.6441
Vendor	0.0000	0.0000	0.0000	0.0000	0.0000	0.0000	0.0000	0.0000	0.0000	0.0000	0.0000	0.0000	0.0000	0.0000	0.0000	0.0000
Worker	1.4000e-004	1.1000e-004	1.5000e-003	0.0000	5.3000e-004	0.0000	5.3000e-004	1.4000e-004	0.0000	1.4000e-004	0.0000	0.4138	0.4138	1.0000e-005	1.0000e-005	0.4171
Total	1.8000e-004	1.7500e-003	1.9400e-003	1.0000e-005	7.0000e-004	1.0000e-005	7.1000e-004	1.9000e-004	1.0000e-005	2.0000e-004	0.0000	1.0272	1.0272	7.0000e-005	1.1000e-004	1.0613

Mitigated Construction On-Site

	ROG	NOx	CO	SO2	Fugitive PM10	Exhaust PM10	PM10 Total	Fugitive PM2.5	Exhaust PM2.5	PM2.5 Total	Bio- CO2	NBio- CO2	Total CO2	CH4	N2O	CO2e
Category	tons/yr										MT/yr					

Orange Park Acres, IRWD - Orange County, Annual

EMFAC Off-Model Adjustment Factors for Gasoline Light Duty Vehicle to Account for the SAFE Vehicle Rule Not Applied

Fugitive Dust					8.3000e-004	0.0000	8.3000e-004	1.3000e-004	0.0000	1.3000e-004	0.0000	0.0000	0.0000	0.0000	0.0000	0.0000
Off-Road	4.6000e-003	0.0438	0.0359	7.0000e-005		2.0900e-003	2.0900e-003		1.9800e-003	1.9800e-003	0.0000	6.2942	6.2942	1.5100e-003	0.0000	6.3319
Total	4.6000e-003	0.0438	0.0359	7.0000e-005	8.3000e-004	2.0900e-003	2.9200e-003	1.3000e-004	1.9800e-003	2.1100e-003	0.0000	6.2942	6.2942	1.5100e-003	0.0000	6.3319

Mitigated Construction Off-Site

	ROG	NOx	CO	SO2	Fugitive PM10	Exhaust PM10	PM10 Total	Fugitive PM2.5	Exhaust PM2.5	PM2.5 Total	Bio- CO2	NBio- CO2	Total CO2	CH4	N2O	CO2e
Category	tons/yr										MT/yr					
Hauling	4.0000e-005	1.6400e-003	4.4000e-004	1.0000e-005	1.7000e-004	1.0000e-005	1.8000e-004	5.0000e-005	1.0000e-005	6.0000e-005	0.0000	0.6134	0.6134	6.0000e-005	1.0000e-004	0.6441
Vendor	0.0000	0.0000	0.0000	0.0000	0.0000	0.0000	0.0000	0.0000	0.0000	0.0000	0.0000	0.0000	0.0000	0.0000	0.0000	0.0000
Worker	1.4000e-004	1.1000e-004	1.5000e-003	0.0000	5.3000e-004	0.0000	5.3000e-004	1.4000e-004	0.0000	1.4000e-004	0.0000	0.4138	0.4138	1.0000e-005	1.0000e-005	0.4171
Total	1.8000e-004	1.7500e-003	1.9400e-003	1.0000e-005	7.0000e-004	1.0000e-005	7.1000e-004	1.9000e-004	1.0000e-005	2.0000e-004	0.0000	1.0272	1.0272	7.0000e-005	1.1000e-004	1.0613

3.3 Grading/Trenching - 2022

Unmitigated Construction On-Site

	ROG	NOx	CO	SO2	Fugitive PM10	Exhaust PM10	PM10 Total	Fugitive PM2.5	Exhaust PM2.5	PM2.5 Total	Bio- CO2	NBio- CO2	Total CO2	CH4	N2O	CO2e
Category	tons/yr										MT/yr					

Orange Park Acres, IRWD - Orange County, Annual

EMFAC Off-Model Adjustment Factors for Gasoline Light Duty Vehicle to Account for the SAFE Vehicle Rule Not Applied

Fugitive Dust					1.0000e-005	0.0000	1.0000e-005	0.0000	0.0000	0.0000	0.0000	0.0000	0.0000	0.0000	0.0000	0.0000
Off-Road	0.0186	0.1637	0.1770	3.2000e-004		8.0100e-003	8.0100e-003		7.6600e-003	7.6600e-003	0.0000	27.8107	27.8107	5.7900e-003	0.0000	27.9555
Total	0.0186	0.1637	0.1770	3.2000e-004	1.0000e-005	8.0100e-003	8.0200e-003	0.0000	7.6600e-003	7.6600e-003	0.0000	27.8107	27.8107	5.7900e-003	0.0000	27.9555

Unmitigated Construction Off-Site

	ROG	NOx	CO	SO2	Fugitive PM10	Exhaust PM10	PM10 Total	Fugitive PM2.5	Exhaust PM2.5	PM2.5 Total	Bio- CO2	NBio- CO2	Total CO2	CH4	N2O	CO2e
Category	tons/yr										MT/yr					
Hauling	4.0000e-005	1.6400e-003	4.4000e-004	1.0000e-005	1.7000e-004	1.0000e-005	1.8000e-004	5.0000e-005	1.0000e-005	6.0000e-005	0.0000	0.6134	0.6134	6.0000e-005	1.0000e-004	0.6441
Vendor	0.0000	0.0000	0.0000	0.0000	0.0000	0.0000	0.0000	0.0000	0.0000	0.0000	0.0000	0.0000	0.0000	0.0000	0.0000	0.0000
Worker	7.0000e-004	5.3000e-004	7.3200e-003	2.0000e-005	2.5700e-003	1.0000e-005	2.5800e-003	6.8000e-004	1.0000e-005	7.0000e-004	0.0000	2.0172	2.0172	5.0000e-005	5.0000e-005	2.0336
Total	7.4000e-004	2.1700e-003	7.7600e-003	3.0000e-005	2.7400e-003	2.0000e-005	2.7600e-003	7.3000e-004	2.0000e-005	7.6000e-004	0.0000	2.6306	2.6306	1.1000e-004	1.5000e-004	2.6777

Mitigated Construction On-Site

	ROG	NOx	CO	SO2	Fugitive PM10	Exhaust PM10	PM10 Total	Fugitive PM2.5	Exhaust PM2.5	PM2.5 Total	Bio- CO2	NBio- CO2	Total CO2	CH4	N2O	CO2e
Category	tons/yr										MT/yr					

Orange Park Acres, IRWD - Orange County, Annual

EMFAC Off-Model Adjustment Factors for Gasoline Light Duty Vehicle to Account for the SAFE Vehicle Rule Not Applied

Fugitive Dust					0.0000	0.0000	0.0000	0.0000	0.0000	0.0000	0.0000	0.0000	0.0000	0.0000	0.0000	0.0000
Off-Road	0.0186	0.1637	0.1770	3.2000e-004		8.0100e-003	8.0100e-003		7.6600e-003	7.6600e-003	0.0000	27.8107	27.8107	5.7900e-003	0.0000	27.9555
Total	0.0186	0.1637	0.1770	3.2000e-004	0.0000	8.0100e-003	8.0100e-003	0.0000	7.6600e-003	7.6600e-003	0.0000	27.8107	27.8107	5.7900e-003	0.0000	27.9555

Mitigated Construction Off-Site

	ROG	NOx	CO	SO2	Fugitive PM10	Exhaust PM10	PM10 Total	Fugitive PM2.5	Exhaust PM2.5	PM2.5 Total	Bio- CO2	NBio- CO2	Total CO2	CH4	N2O	CO2e
Category	tons/yr										MT/yr					
Hauling	4.0000e-005	1.6400e-003	4.4000e-004	1.0000e-005	1.7000e-004	1.0000e-005	1.8000e-004	5.0000e-005	1.0000e-005	6.0000e-005	0.0000	0.6134	0.6134	6.0000e-005	1.0000e-004	0.6441
Vendor	0.0000	0.0000	0.0000	0.0000	0.0000	0.0000	0.0000	0.0000	0.0000	0.0000	0.0000	0.0000	0.0000	0.0000	0.0000	0.0000
Worker	7.0000e-004	5.3000e-004	7.3200e-003	2.0000e-005	2.5700e-003	1.0000e-005	2.5800e-003	6.8000e-004	1.0000e-005	7.0000e-004	0.0000	2.0172	2.0172	5.0000e-005	5.0000e-005	2.0336
Total	7.4000e-004	2.1700e-003	7.7600e-003	3.0000e-005	2.7400e-003	2.0000e-005	2.7600e-003	7.3000e-004	2.0000e-005	7.6000e-004	0.0000	2.6306	2.6306	1.1000e-004	1.5000e-004	2.6777

3.4 Building Construction - 2022

Unmitigated Construction On-Site

	ROG	NOx	CO	SO2	Fugitive PM10	Exhaust PM10	PM10 Total	Fugitive PM2.5	Exhaust PM2.5	PM2.5 Total	Bio- CO2	NBio- CO2	Total CO2	CH4	N2O	CO2e
Category	tons/yr										MT/yr					

Orange Park Acres, IRWD - Orange County, Annual

EMFAC Off-Model Adjustment Factors for Gasoline Light Duty Vehicle to Account for the SAFE Vehicle Rule Not Applied

Total	3.0200e-003	0.0267	0.0305	5.0000e-005		1.3000e-003	1.3000e-003		1.2200e-003	1.2200e-003	0.0000	4.2034	4.2034	1.1800e-003	0.0000	4.2328
-------	-------------	--------	--------	-------------	--	-------------	-------------	--	-------------	-------------	--------	--------	--------	-------------	--------	--------

Mitigated Construction Off-Site

	ROG	NOx	CO	SO2	Fugitive PM10	Exhaust PM10	PM10 Total	Fugitive PM2.5	Exhaust PM2.5	PM2.5 Total	Bio- CO2	NBio- CO2	Total CO2	CH4	N2O	CO2e
Category	tons/yr										MT/yr					
Hauling	4.0000e-005	1.6400e-003	4.4000e-004	1.0000e-005	1.7000e-004	1.0000e-005	1.8000e-004	5.0000e-005	1.0000e-005	6.0000e-005	0.0000	0.6134	0.6134	6.0000e-005	1.0000e-004	0.6441
Vendor	0.0000	0.0000	0.0000	0.0000	0.0000	0.0000	0.0000	0.0000	0.0000	0.0000	0.0000	0.0000	0.0000	0.0000	0.0000	0.0000
Worker	2.7000e-004	2.0000e-004	2.8200e-003	1.0000e-005	9.9000e-004	1.0000e-005	9.9000e-004	2.6000e-004	0.0000	2.7000e-004	0.0000	0.7758	0.7758	2.0000e-005	2.0000e-005	0.7821
Total	3.1000e-004	1.8400e-003	3.2600e-003	2.0000e-005	1.1600e-003	2.0000e-005	1.1700e-003	3.1000e-004	1.0000e-005	3.3000e-004	0.0000	1.3893	1.3893	8.0000e-005	1.2000e-004	1.4263

4.0 Operational Detail - Mobile

4.1 Mitigation Measures Mobile

	ROG	NOx	CO	SO2	Fugitive PM10	Exhaust PM10	PM10 Total	Fugitive PM2.5	Exhaust PM2.5	PM2.5 Total	Bio- CO2	NBio- CO2	Total CO2	CH4	N2O	CO2e
--	-----	-----	----	-----	---------------	--------------	------------	----------------	---------------	-------------	----------	-----------	-----------	-----	-----	------

Orange Park Acres, IRWD - Orange County, Annual

EMFAC Off-Model Adjustment Factors for Gasoline Light Duty Vehicle to Account for the SAFE Vehicle Rule Not Applied

Category	tons/yr										MT/yr					
	Mitigated	0.0000	0.0000	0.0000	0.0000	0.0000	0.0000	0.0000	0.0000	0.0000	0.0000	0.0000	0.0000	0.0000	0.0000	0.0000
Unmitigated	0.0000	0.0000	0.0000	0.0000	0.0000	0.0000	0.0000	0.0000	0.0000	0.0000	0.0000	0.0000	0.0000	0.0000	0.0000	0.0000

4.2 Trip Summary Information

Land Use	Average Daily Trip Rate			Unmitigated Annual VMT	Mitigated Annual VMT
	Weekday	Saturday	Sunday		
User Defined Industrial	0.00	0.00	0.00		
Total	0.00	0.00	0.00		

4.3 Trip Type Information

Land Use	Miles			Trip %			Trip Purpose %		
	H-W or C-W	H-S or C-C	H-O or C-NW	H-W or C-W	H-S or C-C	H-O or C-NW	Primary	Diverted	Pass-by
User Defined Industrial	16.60	8.40	6.90	0.00	0.00	0.00	0	0	0

4.4 Fleet Mix

Land Use	LDA	LDT1	LDT2	MDV	LHD1	LHD2	MHD	HHD	OBUS	UBUS	MCY	SBUS	MH
User Defined Industrial	0.542853	0.058126	0.187899	0.130925	0.024443	0.006426	0.014590	0.004841	0.000666	0.000390	0.024092	0.000735	0.004015

5.0 Energy Detail

Historical Energy Use: N

5.1 Mitigation Measures Energy

Orange Park Acres, IRWD - Orange County, Annual

EMFAC Off-Model Adjustment Factors for Gasoline Light Duty Vehicle to Account for the SAFE Vehicle Rule Not Applied

	ROG	NOx	CO	SO2	Fugitive PM10	Exhaust PM10	PM10 Total	Fugitive PM2.5	Exhaust PM2.5	PM2.5 Total	Bio- CO2	NBio- CO2	Total CO2	CH4	N2O	CO2e
Category	tons/yr										MT/yr					
Electricity Mitigated						0.0000	0.0000		0.0000	0.0000	0.0000	786.5928	786.5928	0.0664	8.0500e-003	790.6507
Electricity Unmitigated						0.0000	0.0000		0.0000	0.0000	0.0000	786.5928	786.5928	0.0664	8.0500e-003	790.6507
NaturalGas Mitigated	0.0000	0.0000	0.0000	0.0000		0.0000	0.0000		0.0000	0.0000	0.0000	0.0000	0.0000	0.0000	0.0000	0.0000
NaturalGas Unmitigated	0.0000	0.0000	0.0000	0.0000		0.0000	0.0000		0.0000	0.0000	0.0000	0.0000	0.0000	0.0000	0.0000	0.0000

5.2 Energy by Land Use - NaturalGas

Unmitigated

	NaturalGas Use	ROG	NOx	CO	SO2	Fugitive PM10	Exhaust PM10	PM10 Total	Fugitive PM2.5	Exhaust PM2.5	PM2.5 Total	Bio- CO2	NBio- CO2	Total CO2	CH4	N2O	CO2e
Land Use	kBTU/yr	tons/yr										MT/yr					
User Defined Industrial	0	0.0000	0.0000	0.0000	0.0000		0.0000	0.0000		0.0000	0.0000	0.0000	0.0000	0.0000	0.0000	0.0000	0.0000
Total		0.0000	0.0000	0.0000	0.0000		0.0000	0.0000		0.0000	0.0000	0.0000	0.0000	0.0000	0.0000	0.0000	0.0000

Mitigated

	NaturalGas Use	ROG	NOx	CO	SO2	Fugitive PM10	Exhaust PM10	PM10 Total	Fugitive PM2.5	Exhaust PM2.5	PM2.5 Total	Bio- CO2	NBio- CO2	Total CO2	CH4	N2O	CO2e
--	----------------	-----	-----	----	-----	---------------	--------------	------------	----------------	---------------	-------------	----------	-----------	-----------	-----	-----	------

Orange Park Acres, IRWD - Orange County, Annual

EMFAC Off-Model Adjustment Factors for Gasoline Light Duty Vehicle to Account for the SAFE Vehicle Rule Not Applied

Land Use	kBTU/yr	tons/yr										MT/yr					
User Defined Industrial	0	0.0000	0.0000	0.0000	0.0000	0.0000	0.0000	0.0000	0.0000	0.0000	0.0000	0.0000	0.0000	0.0000	0.0000	0.0000	0.0000
Total		0.0000	0.0000	0.0000	0.0000	0.0000	0.0000	0.0000	0.0000	0.0000	0.0000	0.0000	0.0000	0.0000	0.0000	0.0000	0.0000

5.3 Energy by Land Use - Electricity

Unmitigated

	Electricity Use	Total CO2	CH4	N2O	CO2e
Land Use	kWh/yr	MT/yr			
User Defined Industrial	4.43537e+006	786.5928	0.0664	8.0500e-003	790.6507
Total		786.5928	0.0664	8.0500e-003	790.6507

Mitigated

	Electricity Use	Total CO2	CH4	N2O	CO2e
Land Use	kWh/yr	MT/yr			
User Defined Industrial	4.43537e+006	786.5928	0.0664	8.0500e-003	790.6507
Total		786.5928	0.0664	8.0500e-003	790.6507

Orange Park Acres, IRWD - Orange County, Annual

EMFAC Off-Model Adjustment Factors for Gasoline Light Duty Vehicle to Account for the SAFE Vehicle Rule Not Applied

6.0 Area Detail

6.1 Mitigation Measures Area

	ROG	NOx	CO	SO2	Fugitive PM10	Exhaust PM10	PM10 Total	Fugitive PM2.5	Exhaust PM2.5	PM2.5 Total	Bio- CO2	NBio- CO2	Total CO2	CH4	N2O	CO2e
Category	tons/yr										MT/yr					
Mitigated	0.0677	0.0000	1.0000e-005	0.0000		0.0000	0.0000		0.0000	0.0000	0.0000	2.0000e-005	2.0000e-005	0.0000	0.0000	3.0000e-005
Unmitigated	0.0677	0.0000	1.0000e-005	0.0000		0.0000	0.0000		0.0000	0.0000	0.0000	2.0000e-005	2.0000e-005	0.0000	0.0000	3.0000e-005

6.2 Area by SubCategory

Unmitigated

	ROG	NOx	CO	SO2	Fugitive PM10	Exhaust PM10	PM10 Total	Fugitive PM2.5	Exhaust PM2.5	PM2.5 Total	Bio- CO2	NBio- CO2	Total CO2	CH4	N2O	CO2e
SubCategory	tons/yr										MT/yr					
Architectural Coating	7.7000e-003					0.0000	0.0000		0.0000	0.0000	0.0000	0.0000	0.0000	0.0000	0.0000	0.0000
Consumer Products	0.0600					0.0000	0.0000		0.0000	0.0000	0.0000	0.0000	0.0000	0.0000	0.0000	0.0000
Landscaping	0.0000	0.0000	1.0000e-005	0.0000		0.0000	0.0000		0.0000	0.0000	0.0000	2.0000e-005	2.0000e-005	0.0000	0.0000	3.0000e-005

Orange Park Acres, IRWD - Orange County, Annual

EMFAC Off-Model Adjustment Factors for Gasoline Light Duty Vehicle to Account for the SAFE Vehicle Rule Not Applied

Total	0.0677	0.0000	1.0000e-005	0.0000		0.0000	0.0000		0.0000	0.0000	0.0000	2.0000e-005	2.0000e-005	0.0000	0.0000	3.0000e-005
--------------	---------------	---------------	--------------------	---------------	--	---------------	---------------	--	---------------	---------------	---------------	--------------------	--------------------	---------------	---------------	--------------------

Mitigated

	ROG	NOx	CO	SO2	Fugitive PM10	Exhaust PM10	PM10 Total	Fugitive PM2.5	Exhaust PM2.5	PM2.5 Total	Bio- CO2	NBio- CO2	Total CO2	CH4	N2O	CO2e
SubCategory	tons/yr										MT/yr					
Architectural Coating	7.7000e-003					0.0000	0.0000		0.0000	0.0000	0.0000	0.0000	0.0000	0.0000	0.0000	0.0000
Consumer Products	0.0600					0.0000	0.0000		0.0000	0.0000	0.0000	0.0000	0.0000	0.0000	0.0000	0.0000
Landscaping	0.0000	0.0000	1.0000e-005	0.0000		0.0000	0.0000		0.0000	0.0000	0.0000	2.0000e-005	2.0000e-005	0.0000	0.0000	3.0000e-005
Total	0.0677	0.0000	1.0000e-005	0.0000		0.0000	0.0000		0.0000	0.0000	0.0000	2.0000e-005	2.0000e-005	0.0000	0.0000	3.0000e-005

7.0 Water Detail

7.1 Mitigation Measures Water

	Total CO2	CH4	N2O	CO2e
Category	MT/yr			

Orange Park Acres, IRWD - Orange County, Annual

EMFAC Off-Model Adjustment Factors for Gasoline Light Duty Vehicle to Account for the SAFE Vehicle Rule Not Applied

Mitigated	0.0000	0.0000	0.0000	0.0000
Unmitigated	0.0000	0.0000	0.0000	0.0000

7.2 Water by Land Use

Unmitigated

	Indoor/Outdoor Use	Total CO2	CH4	N2O	CO2e
Land Use	Mgal	MT/yr			
User Defined Industrial	0 / 0	0.0000	0.0000	0.0000	0.0000
Total		0.0000	0.0000	0.0000	0.0000

Mitigated

	Indoor/Outdoor Use	Total CO2	CH4	N2O	CO2e
Land Use	Mgal	MT/yr			
User Defined Industrial	0 / 0	0.0000	0.0000	0.0000	0.0000
Total		0.0000	0.0000	0.0000	0.0000

Orange Park Acres, IRWD - Orange County, Annual

EMFAC Off-Model Adjustment Factors for Gasoline Light Duty Vehicle to Account for the SAFE Vehicle Rule Not Applied

8.0 Waste Detail

8.1 Mitigation Measures Waste

Category/Year

	Total CO2	CH4	N2O	CO2e
	MT/yr			
Mitigated	0.0000	0.0000	0.0000	0.0000
Unmitigated	0.0000	0.0000	0.0000	0.0000

8.2 Waste by Land Use

Unmitigated

	Waste Disposed	Total CO2	CH4	N2O	CO2e
Land Use	tons	MT/yr			
User Defined Industrial	0	0.0000	0.0000	0.0000	0.0000
Total		0.0000	0.0000	0.0000	0.0000

Orange Park Acres, IRWD - Orange County, Annual

EMFAC Off-Model Adjustment Factors for Gasoline Light Duty Vehicle to Account for the SAFE Vehicle Rule Not Applied

Mitigated

	Waste Disposed	Total CO2	CH4	N2O	CO2e
Land Use	tons	MT/yr			
User Defined Industrial	0	0.0000	0.0000	0.0000	0.0000
Total		0.0000	0.0000	0.0000	0.0000

9.0 Operational Offroad

Equipment Type	Number	Hours/Day	Days/Year	Horse Power	Load Factor	Fuel Type
----------------	--------	-----------	-----------	-------------	-------------	-----------

10.0 Stationary Equipment

Fire Pumps and Emergency Generators

Equipment Type	Number	Hours/Day	Hours/Year	Horse Power	Load Factor	Fuel Type
----------------	--------	-----------	------------	-------------	-------------	-----------

Boilers

Equipment Type	Number	Heat Input/Day	Heat Input/Year	Boiler Rating	Fuel Type
----------------	--------	----------------	-----------------	---------------	-----------

User Defined Equipment

Equipment Type	Number
----------------	--------

11.0 Vegetation

APPENDIX B

EDR HAZARDOUS MATERIALS DATABASE REPORT

Orange Park Acres Well Replacement Project

678 North Gravier Street

Orange, CA 92869

Inquiry Number: 6531282.2s

June 10, 2021

The EDR Radius Map™ Report with GeoCheck®



6 Armstrong Road, 4th floor
Shelton, CT 06484
Toll Free: 800.352.0050
www.edrnet.com

TABLE OF CONTENTS

<u>SECTION</u>	<u>PAGE</u>
Executive Summary	ES1
Overview Map	2
Detail Map	3
Map Findings Summary	4
Map Findings	9
Orphan Summary	97
Government Records Searched/Data Currency Tracking	GR-1
 <u>GEOCHECK ADDENDUM</u>	
Physical Setting Source Addendum	A-1
Physical Setting Source Summary	A-2
Physical Setting SSURGO Soil Map	A-5
Physical Setting Source Map	A-10
Physical Setting Source Map Findings	A-12
Physical Setting Source Records Searched	PSGR-1

Thank you for your business.
Please contact EDR at 1-800-352-0050
with any questions or comments.

Disclaimer - Copyright and Trademark Notice

This Report contains certain information obtained from a variety of public and other sources reasonably available to Environmental Data Resources, Inc. It cannot be concluded from this Report that coverage information for the target and surrounding properties does not exist from other sources. **NO WARRANTY EXPRESSED OR IMPLIED, IS MADE WHATSOEVER IN CONNECTION WITH THIS REPORT. ENVIRONMENTAL DATA RESOURCES, INC. SPECIFICALLY DISCLAIMS THE MAKING OF ANY SUCH WARRANTIES, INCLUDING WITHOUT LIMITATION, MERCHANTABILITY OR FITNESS FOR A PARTICULAR USE OR PURPOSE. ALL RISK IS ASSUMED BY THE USER. IN NO EVENT SHALL ENVIRONMENTAL DATA RESOURCES, INC. BE LIABLE TO ANYONE, WHETHER ARISING OUT OF ERRORS OR OMISSIONS, NEGLIGENCE, ACCIDENT OR ANY OTHER CAUSE, FOR ANY LOSS OF DAMAGE, INCLUDING, WITHOUT LIMITATION, SPECIAL, INCIDENTAL, CONSEQUENTIAL, OR EXEMPLARY DAMAGES. ANY LIABILITY ON THE PART OF ENVIRONMENTAL DATA RESOURCES, INC. IS STRICTLY LIMITED TO A REFUND OF THE AMOUNT PAID FOR THIS REPORT.** Purchaser accepts this Report "AS IS". Any analyses, estimates, ratings, environmental risk levels or risk codes provided in this Report are provided for illustrative purposes only, and are not intended to provide, nor should they be interpreted as providing any facts regarding, or prediction or forecast of, any environmental risk for any property. Only a Phase I Environmental Site Assessment performed by an environmental professional can provide information regarding the environmental risk for any property. Additionally, the information provided in this Report is not to be construed as legal advice.

Copyright 2020 by Environmental Data Resources, Inc. All rights reserved. Reproduction in any media or format, in whole or in part, of any report or map of Environmental Data Resources, Inc., or its affiliates, is prohibited without prior written permission.

EDR and its logos (including Sanborn and Sanborn Map) are trademarks of Environmental Data Resources, Inc. or its affiliates. All other trademarks used herein are the property of their respective owners.

EXECUTIVE SUMMARY

A search of available environmental records was conducted by Environmental Data Resources, Inc (EDR). The report was designed to assist parties seeking to meet the search requirements of EPA's Standards and Practices for All Appropriate Inquiries (40 CFR Part 312), the ASTM Standard Practice for Environmental Site Assessments (E 1527-13), the ASTM Standard Practice for Environmental Site Assessments for Forestland or Rural Property (E 2247-16), the ASTM Standard Practice for Limited Environmental Due Diligence: Transaction Screen Process (E 1528-14) or custom requirements developed for the evaluation of environmental risk associated with a parcel of real estate.

TARGET PROPERTY INFORMATION

ADDRESS

678 NORTH GRAVIER STREET
ORANGE, CA 92869

COORDINATES

Latitude (North): 33.7981580 - 33° 47' 53.36"
Longitude (West): 117.8147200 - 117° 48' 52.99"
Universal Transverse Mercator: Zone 11
UTM X (Meters): 424582.2
UTM Y (Meters): 3739881.0
Elevation: 298 ft. above sea level

USGS TOPOGRAPHIC MAP ASSOCIATED WITH TARGET PROPERTY

Target Property Map: 5641308 ORANGE, CA
Version Date: 2012

AERIAL PHOTOGRAPHY IN THIS REPORT

Portions of Photo from: 20140515, 20140513, 20140514
Source: USDA

MAPPED SITES SUMMARY

Target Property Address:
678 NORTH GRAVIER STREET
ORANGE, CA 92869

Click on Map ID to see full detail.

MAP ID	SITE NAME	ADDRESS	DATABASE ACRONYMS	RELATIVE ELEVATION	DIST (ft. & mi.) DIRECTION
A1	IRWD OPA-1	678 NORTH GRAVIER ST	CIWQS		TP
A2	IRWD OPA-1	678 GRAVIER	CERS		TP
A3	IRWD - OPA 1 WELL	678 GRAVIER	CERS		TP
A4	IRVINE RANCH WATER D	678 N GRAVIER ST	HAZNET, HWTS		TP
A5	ORANGE PARK ACRES MW	678 NORTH GRAVIER ST	FINDS		TP
A6	IRWD OPA-1	678 GRAVIER	FINDS		TP
A7	ORANGE PARK ACRES MW		ECHO	Higher	1 ft.
8	MAC MORANTE	650 N JAMES ST	RCRA NonGen / NLR	Higher	236, 0.045, ESE
9	KEVIN CARMODY	691 N LA NAE CIR	RCRA NonGen / NLR	Higher	704, 0.133, East
B10	JOSE ESPARZA	558 N LA NAE CIR	RCRA NonGen / NLR	Higher	882, 0.167, SE
B11	BRET VINCENT	557 NORTH LA NAE CIR	RCRA NonGen / NLR	Higher	981, 0.186, SE
B12	SAM MAFFEY	568 N RICK ST	RCRA NonGen / NLR	Higher	1047, 0.198, SE
13	BILL COX	4002 E EL CARMEN AVE	RCRA NonGen / NLR	Higher	1092, 0.207, ESE
C14	JASMIN ESCUTIA	4010 E CHARTER OAK D	RCRA NonGen / NLR	Higher	1157, 0.219, East
C15	JOEY STOKES-KING	4020 E CHARTER OAK D	RCRA NonGen / NLR	Higher	1180, 0.223, East
C16	JOEY STOKES-KING	4020 E CHARTER OAK D	RCRA NonGen / NLR	Higher	1180, 0.223, East
17	ROBERT FOYLE	3803 EUCLID AVE	RCRA NonGen / NLR	Lower	1246, 0.236, SSE
D18	MICHAEL BRADBURY	3340 E COLLINS AVE A	RCRA NonGen / NLR	Higher	1260, 0.239, NW
D19	ADAM TOMBELAINE	3340 E COLLINS #61	RCRA NonGen / NLR	Higher	1260, 0.239, NW
D20	STEVE HAMRELL	3340 EAST COLLINS AV	RCRA NonGen / NLR	Higher	1260, 0.239, NW
D21	CHARLENE LIEBELT	3340 EAST COLLINS AV	RCRA NonGen / NLR	Higher	1260, 0.239, NW
D22	MIKE BRADBURY	3340 E COLLINS AVE	RCRA NonGen / NLR	Higher	1260, 0.239, NW
C23	RICHARD ROHR	4031 E CHARTER OAK D	RCRA NonGen / NLR	Higher	1265, 0.240, East
E24	CAL MAT FACILITY	454 PROSPECT	LUST, Cortese, CERS	Lower	1608, 0.305, SW
E25	CAL-MAT COMPANY	454 PROSPECT	HIST CORTESE	Lower	1631, 0.309, SW
E26	CAL MAT FACILITY	454 PROSPECT	LUST, EMI	Lower	1634, 0.309, SW
E27	OWL ROCK PRODUCTS CO	454 N PROSPECT AVE	LUST, EMI, CERS	Lower	1634, 0.309, SW
F28	GRIJALVA EXTENSION	368 N. PROSPECT AVEN	US BROWNFIELDS, FINDS	Lower	2125, 0.402, SSW
F29	GRIJALVA SITE	368 N PROSPECT ST.	CPS-SLIC	Lower	2125, 0.402, SSW
G30	EL MODENA HIGH SCHOO	3920 SPRING ST	RCRA-SQG, LUST, FINDS, HIST CORTESE	Lower	2435, 0.461, SSE
G31	EL MODENA HIGH SCHOO	3920 E SPRING	LUST, Cortese, CERS	Lower	2435, 0.461, SSE
32	CITY OF ORANGE SANTI	PROSPECT AND SPRING	SWF/LF, CERS	Lower	2515, 0.476, SSW
33	DANNY'S CLEANERS 2	3534 E CHAPMAN AVE	ENVIROSTOR, VCP, DRYCLEANERS, HAZNET, HWTS	Lower	3703, 0.701, South

EXECUTIVE SUMMARY

TARGET PROPERTY SEARCH RESULTS

The target property was identified in the following records. For more information on this property see page 9 of the attached EDR Radius Map report:

Site	Database(s)	EPA ID
IRWD OPA-1 678 NORTH GRAVIER ST ORANGE, CA 92869	CIWQS	N/A
IRWD OPA-1 678 GRAVIER ORANGE, CA 92869	CERS	N/A
IRWD - OPA 1 WELL 678 GRAVIER ORANGE, CA 92869	CERS	N/A
IRVINE RANCH WATER D 678 N GRAVIER ST ORANGE, CA 92869	HAZNET GEPAID: CAC002635139 HWTS	N/A
ORANGE PARK ACRES MW 678 NORTH GRAVIER ST ORANGE, CA 92669	FINDS	N/A
IRWD OPA-1 678 GRAVIER ORANGE, CA 92869	FINDS Registry ID:: 110065360709	N/A

DATABASES WITH NO MAPPED SITES

No mapped sites were found in EDR's search of available ("reasonably ascertainable ") government records either on the target property or within the search radius around the target property for the following databases:

STANDARD ENVIRONMENTAL RECORDS

Federal NPL site list

NPL..... National Priority List
Proposed NPL..... Proposed National Priority List Sites

EXECUTIVE SUMMARY

NPL LIENS..... Federal Superfund Liens

Federal Delisted NPL site list

Delisted NPL..... National Priority List Deletions

Federal CERCLIS list

FEDERAL FACILITY..... Federal Facility Site Information listing

SEMS..... Superfund Enterprise Management System

Federal CERCLIS NFRAP site list

SEMS-ARCHIVE..... Superfund Enterprise Management System Archive

Federal RCRA CORRACTS facilities list

CORRACTS..... Corrective Action Report

Federal RCRA non-CORRACTS TSD facilities list

RCRA-TSDF..... RCRA - Treatment, Storage and Disposal

Federal RCRA generators list

RCRA-LQG..... RCRA - Large Quantity Generators

RCRA-SQG..... RCRA - Small Quantity Generators

RCRA-VSQG..... RCRA - Very Small Quantity Generators (Formerly Conditionally Exempt Small Quantity Generators)

Federal institutional controls / engineering controls registries

LUCIS..... Land Use Control Information System

US ENG CONTROLS..... Engineering Controls Sites List

US INST CONTROLS..... Institutional Controls Sites List

Federal ERNS list

ERNS..... Emergency Response Notification System

State- and tribal - equivalent NPL

RESPONSE..... State Response Sites

State and tribal leaking storage tank lists

INDIAN LUST..... Leaking Underground Storage Tanks on Indian Land

State and tribal registered storage tank lists

FEMA UST..... Underground Storage Tank Listing

UST..... Active UST Facilities

AST..... Aboveground Petroleum Storage Tank Facilities

INDIAN UST..... Underground Storage Tanks on Indian Land

State and tribal voluntary cleanup sites

INDIAN VCP..... Voluntary Cleanup Priority Listing

EXECUTIVE SUMMARY

VCP..... Voluntary Cleanup Program Properties

State and tribal Brownfields sites

BROWNFIELDS..... Considered Brownfields Sites Listing

ADDITIONAL ENVIRONMENTAL RECORDS

Local Lists of Landfill / Solid Waste Disposal Sites

WMUDS/SWAT..... Waste Management Unit Database
SWRCY..... Recycler Database
HAULERS..... Registered Waste Tire Haulers Listing
INDIAN ODI..... Report on the Status of Open Dumps on Indian Lands
ODI..... Open Dump Inventory
DEBRIS REGION 9..... Torres Martinez Reservation Illegal Dump Site Locations
IHS OPEN DUMPS..... Open Dumps on Indian Land

Local Lists of Hazardous waste / Contaminated Sites

US HIST CDL..... Delisted National Clandestine Laboratory Register
HIST Cal-Sites..... Historical Calsites Database
SCH..... School Property Evaluation Program
CDL..... Clandestine Drug Labs
Toxic Pits..... Toxic Pits Cleanup Act Sites
CERS HAZ WASTE..... CERS HAZ WASTE
US CDL..... National Clandestine Laboratory Register
PFAS..... PFAS Contamination Site Location Listing

Local Lists of Registered Storage Tanks

SWEEPS UST..... SWEEPS UST Listing
HIST UST..... Hazardous Substance Storage Container Database
CA FID UST..... Facility Inventory Database
CERS TANKS..... California Environmental Reporting System (CERS) Tanks

Local Land Records

LIENS..... Environmental Liens Listing
LIENS 2..... CERCLA Lien Information
DEED..... Deed Restriction Listing

Records of Emergency Release Reports

HMIRS..... Hazardous Materials Information Reporting System
CHMIRS..... California Hazardous Material Incident Report System
LDS..... Land Disposal Sites Listing
MCS..... Military Cleanup Sites Listing
Orange Co. Industrial Site..... List of Industrial Site Cleanups
SPILLS 90..... SPILLS 90 data from FirstSearch

Other Ascertainable Records

FUDS..... Formerly Used Defense Sites

EXECUTIVE SUMMARY

DOD.....	Department of Defense Sites
SCRD DRYCLEANERS.....	State Coalition for Remediation of Drycleaners Listing
US FIN ASSUR.....	Financial Assurance Information
EPA WATCH LIST.....	EPA WATCH LIST
2020 COR ACTION.....	2020 Corrective Action Program List
TSCA.....	Toxic Substances Control Act
TRIS.....	Toxic Chemical Release Inventory System
SSTS.....	Section 7 Tracking Systems
ROD.....	Records Of Decision
RMP.....	Risk Management Plans
RAATS.....	RCRA Administrative Action Tracking System
PRP.....	Potentially Responsible Parties
PADS.....	PCB Activity Database System
ICIS.....	Integrated Compliance Information System
FTTS.....	FIFRA/ TSCA Tracking System - FIFRA (Federal Insecticide, Fungicide, & Rodenticide Act)/TSCA (Toxic Substances Control Act)
MLTS.....	Material Licensing Tracking System
COAL ASH DOE.....	Steam-Electric Plant Operation Data
COAL ASH EPA.....	Coal Combustion Residues Surface Impoundments List
PCB TRANSFORMER.....	PCB Transformer Registration Database
RADINFO.....	Radiation Information Database
HIST FTTS.....	FIFRA/TSCA Tracking System Administrative Case Listing
DOT OPS.....	Incident and Accident Data
CONSENT.....	Superfund (CERCLA) Consent Decrees
INDIAN RESERV.....	Indian Reservations
FUSRAP.....	Formerly Utilized Sites Remedial Action Program
UMTRA.....	Uranium Mill Tailings Sites
LEAD SMELTERS.....	Lead Smelter Sites
US AIRS.....	Aerometric Information Retrieval System Facility Subsystem
US MINES.....	Mines Master Index File
ABANDONED MINES.....	Abandoned Mines
UXO.....	Unexploded Ordnance Sites
DOCKET HWC.....	Hazardous Waste Compliance Docket Listing
FUELS PROGRAM.....	EPA Fuels Program Registered Listing
CA BOND EXP. PLAN.....	Bond Expenditure Plan
CUPA Listings.....	CUPA Resources List
DRYCLEANERS.....	Cleaner Facilities
EMI.....	Emissions Inventory Data
ENF.....	Enforcement Action Listing
Financial Assurance.....	Financial Assurance Information Listing
ICE.....	ICE
HWP.....	EnviroStor Permitted Facilities Listing
HWT.....	Registered Hazardous Waste Transporter Database
MINES.....	Mines Site Location Listing
MWMP.....	Medical Waste Management Program Listing
NPDES.....	NPDES Permits Listing
PEST LIC.....	Pesticide Regulation Licenses Listing
PROC.....	Certified Processors Database
Notify 65.....	Proposition 65 Records
UIC.....	UIC Listing
UIC GEO.....	UIC GEO (GEOTRACKER)
WASTEWATER PITS.....	Oil Wastewater Pits Listing
WDS.....	Waste Discharge System
WIP.....	Well Investigation Program Case List
MILITARY PRIV SITES.....	MILITARY PRIV SITES (GEOTRACKER)

EXECUTIVE SUMMARY

PROJECT.....	PROJECT (GEOTRACKER)
WDR.....	Waste Discharge Requirements Listing
NON-CASE INFO.....	NON-CASE INFO (GEOTRACKER)
OTHER OIL GAS.....	OTHER OIL & GAS (GEOTRACKER)
PROD WATER PONDS.....	PROD WATER PONDS (GEOTRACKER)
SAMPLING POINT.....	SAMPLING POINT (GEOTRACKER)
WELL STIM PROJ.....	Well Stimulation Project (GEOTRACKER)
MINES MRDS.....	Mineral Resources Data System

EDR HIGH RISK HISTORICAL RECORDS

EDR Exclusive Records

EDR MGP.....	EDR Proprietary Manufactured Gas Plants
EDR Hist Auto.....	EDR Exclusive Historical Auto Stations
EDR Hist Cleaner.....	EDR Exclusive Historical Cleaners

EDR RECOVERED GOVERNMENT ARCHIVES

Exclusive Recovered Govt. Archives

RGA LF.....	Recovered Government Archive Solid Waste Facilities List
RGA LUST.....	Recovered Government Archive Leaking Underground Storage Tank

SURROUNDING SITES: SEARCH RESULTS

Surrounding sites were identified in the following databases.

Elevations have been determined from the USGS Digital Elevation Model and should be evaluated on a relative (not an absolute) basis. Relative elevation information between sites of close proximity should be field verified. Sites with an elevation equal to or higher than the target property have been differentiated below from sites with an elevation lower than the target property.

Page numbers and map identification numbers refer to the EDR Radius Map report where detailed data on individual sites can be reviewed.

Sites listed in ***bold italics*** are in multiple databases.

Unmappable (orphan) sites are not considered in the foregoing analysis.

STANDARD ENVIRONMENTAL RECORDS

State- and tribal - equivalent CERCLIS

ENVIROSTOR: The Department of Toxic Substances Control's (DTSC's) Site Mitigation and Brownfields Reuse Program's (SMBRP's) EnviroStor database identifies sites that have known contamination or sites for which there may be reasons to investigate further. The database includes the following site types: Federal Superfund sites (National Priorities List (NPL)); State Response, including Military Facilities and State Superfund; Voluntary Cleanup; and School sites. EnviroStor provides similar information to the information that was available in CalSites, and provides additional site information, including, but not limited to, identification of formerly-contaminated properties that have been released for reuse, properties where environmental deed restrictions have been recorded to prevent inappropriate land uses, and risk characterization information that is used to assess potential impacts to public health and the environment at contaminated sites.

A review of the ENVIROSTOR list, as provided by EDR, and dated 01/25/2021 has revealed that there is

EXECUTIVE SUMMARY

1 ENVIROSTOR site within approximately 1 mile of the target property.

<u>Lower Elevation</u>	<u>Address</u>	<u>Direction / Distance</u>	<u>Map ID</u>	<u>Page</u>
DANNY'S CLEANERS 2 Facility Id: 60002428 Status: Active	3534 E CHAPMAN AVE	S 1/2 - 1 (0.701 mi.)	33	87

State and tribal landfill and/or solid waste disposal site lists

SWF/LF: The Solid Waste Facilities/Landfill Sites records typically contain an inventory of solid waste disposal facilities or landfills in a particular state. The data come from the Integrated Waste Management Board's Solid Waste Information System (SWIS) database.

A review of the SWF/LF list, as provided by EDR, has revealed that there is 1 SWF/LF site within approximately 0.5 miles of the target property.

<u>Lower Elevation</u>	<u>Address</u>	<u>Direction / Distance</u>	<u>Map ID</u>	<u>Page</u>
CITY OF ORANGE SANTI Database: SWF/LF (SWIS), Date of Government Version: 02/08/2021 Facility ID: 30-CR-0164 Operational Status: Closed Regulation Status: Pre-regulation	PROSPECT AND SPRING	SSW 1/4 - 1/2 (0.476 mi.)	32	84

State and tribal leaking storage tank lists

LUST: Leaking Underground Storage Tank (LUST) Sites included in GeoTracker. GeoTracker is the Water Boards data management system for sites that impact, or have the potential to impact, water quality in California, with emphasis on groundwater.

A review of the LUST list, as provided by EDR, has revealed that there are 5 LUST sites within approximately 0.5 miles of the target property.

<u>Lower Elevation</u>	<u>Address</u>	<u>Direction / Distance</u>	<u>Map ID</u>	<u>Page</u>
CAL MAT FACILITY Database: LUST REG 8, Date of Government Version: 02/14/2005 Facility Status: Case Closed Global ID: T0605900740	454 PROSPECT	SW 1/4 - 1/2 (0.305 mi.)	E24	55
CAL MAT FACILITY Database: LUST, Date of Government Version: 03/08/2021 Global Id: T0605900740 Status: Completed - Case Closed	454 PROSPECT	SW 1/4 - 1/2 (0.309 mi.)	E26	58
OWL ROCK PRODUCTS CO Database: ORANGE CO. LUST, Date of Government Version: 03/01/2021 Facility Id: 85UT003	454 N PROSPECT AVE	SW 1/4 - 1/2 (0.309 mi.)	E27	61
EL MODENA HIGH SCHOO Database: LUST REG 8, Date of Government Version: 02/14/2005 Facility Status: Case Closed Global ID: T0605900933	3920 SPRING ST	SSE 1/4 - 1/2 (0.461 mi.)	G30	77
EL MODENA HIGH SCHOO Database: LUST, Date of Government Version: 03/08/2021	3920 E SPRING	SSE 1/4 - 1/2 (0.461 mi.)	G31	81

EXECUTIVE SUMMARY

Global Id: T0605900933
Status: Completed - Case Closed

CPS-SLIC: Cleanup Program Sites (CPS; also known as Site Cleanups [SC] and formerly known as Spills, Leaks, Investigations, and Cleanups [SLIC] sites) included in GeoTracker. GeoTracker is the Water Boards data management system for sites that impact, or have the potential to impact, water quality in California, with emphasis on groundwater.

A review of the CPS-SLIC list, as provided by EDR, has revealed that there is 1 CPS-SLIC site within approximately 0.5 miles of the target property.

<u>Lower Elevation</u>	<u>Address</u>	<u>Direction / Distance</u>	<u>Map ID</u>	<u>Page</u>
GRIJALVA SITE Database: SLIC REG 8, Date of Government Version: 04/03/2008	368 N PROSPECT ST.	SSW 1/4 - 1/2 (0.402 mi.)	F29	77

ADDITIONAL ENVIRONMENTAL RECORDS

Local Brownfield lists

US BROWNFIELDS: The EPA's listing of Brownfields properties from the Cleanups in My Community program, which provides information on Brownfields properties for which information is reported back to EPA, as well as areas served by Brownfields grant programs.

A review of the US BROWNFIELDS list, as provided by EDR, and dated 12/11/2020 has revealed that there is 1 US BROWNFIELDS site within approximately 0.5 miles of the target property.

<u>Lower Elevation</u>	<u>Address</u>	<u>Direction / Distance</u>	<u>Map ID</u>	<u>Page</u>
GRIJALVA EXTENSION Cleanup Completion Date: - ACRES property ID: 12260	368 N. PROSPECT AVEN	SSW 1/4 - 1/2 (0.402 mi.)	F28	62

Other Ascertainable Records

RCRA NonGen / NLR: RCRAInfo is EPA's comprehensive information system, providing access to data supporting the Resource Conservation and Recovery Act (RCRA) of 1976 and the Hazardous and Solid Waste Amendments (HSWA) of 1984. The database includes selective information on sites which generate, transport, store, treat and/or dispose of hazardous waste as defined by the Resource Conservation and Recovery Act (RCRA). Non-Generators do not presently generate hazardous waste.

A review of the RCRA NonGen / NLR list, as provided by EDR, and dated 03/22/2021 has revealed that there are 16 RCRA NonGen / NLR sites within approximately 0.25 miles of the target property.

<u>Equal/Higher Elevation</u>	<u>Address</u>	<u>Direction / Distance</u>	<u>Map ID</u>	<u>Page</u>
MAC MORANTE EPA ID:: CAC002992735	650 N JAMES ST	ESE 0 - 1/8 (0.045 mi.)	8	15
KEVIN CARMODY	691 N LA NAE CIR	E 1/8 - 1/4 (0.133 mi.)	9	18

EXECUTIVE SUMMARY

EPA ID:: CAC002969634				
JOSE ESPARZA	558 N LA NAE CIR	SE 1/8 - 1/4 (0.167 mi.)	B10	20
EPA ID:: CAC003019735				
BRET VINCENT	557 NORTH LA NAE CIR	SE 1/8 - 1/4 (0.186 mi.)	B11	23
SAM MAFFEY	568 N RICK ST	SE 1/8 - 1/4 (0.198 mi.)	B12	25
EPA ID:: CAC003035901				
BILL COX	4002 E EL CARMEN AVE	ESE 1/8 - 1/4 (0.207 mi.)	13	28
EPA ID:: CAC003059509				
JASMIN ESCUTIA	4010 E CHARTER OAK D	E 1/8 - 1/4 (0.219 mi.)	C14	30
EPA ID:: CAC003001788				
JOEY STOKES-KING	4020 E CHARTER OAK D	E 1/8 - 1/4 (0.223 mi.)	C15	33
EPA ID:: CAC003001828				
JOEY STOKES-KING	4020 E CHARTER OAK D	E 1/8 - 1/4 (0.223 mi.)	C16	35
EPA ID:: CAC002991919				
MICHAEL BRADBURY	3340 E COLLINS AVE A	NW 1/8 - 1/4 (0.239 mi.)	D18	40
EPA ID:: CAC003042661				
ADAM TOMBELAINE	3340 E COLLINS #61	NW 1/8 - 1/4 (0.239 mi.)	D19	43
EPA ID:: CAC002973577				
STEVE HAMRELL	3340 EAST COLLINS AV	NW 1/8 - 1/4 (0.239 mi.)	D20	45
EPA ID:: CAC002967168				
CHARLENE LIEBELT	3340 EAST COLLINS AV	NW 1/8 - 1/4 (0.239 mi.)	D21	48
EPA ID:: CAC003036373				
MIKE BRADBURY	3340 E COLLINS AVE	NW 1/8 - 1/4 (0.239 mi.)	D22	50
RICHARD ROHR	4031 E CHARTER OAK D	E 1/8 - 1/4 (0.240 mi.)	C23	53
EPA ID:: CAC002973781				

<u>Lower Elevation</u>	<u>Address</u>	<u>Direction / Distance</u>	<u>Map ID</u>	<u>Page</u>
ROBERT FOYLE	3803 EUCLID AVE	SSE 1/8 - 1/4 (0.236 mi.)	17	38
EPA ID:: CAC003001511				

ECHO: ECHO provides integrated compliance and enforcement information for about 800,000 regulated facilities nationwide.

A review of the ECHO list, as provided by EDR, and dated 01/02/2021 has revealed that there is 1 ECHO site within approximately 0.001 miles of the target property.

<u>Equal/Higher Elevation</u>	<u>Address</u>	<u>Direction / Distance</u>	<u>Map ID</u>	<u>Page</u>
ORANGE PARK ACRES MW		0 - 1/8 (0.000 mi.)	A7	15
Registry ID: 110013152300				

Cortese: The sites for the list are designated by the State Water Resource Control Board (LUST), the Integrated Waste Board (SWF/LS), and the Department of Toxic Substances Control (Cal-Sites).

A review of the Cortese list, as provided by EDR, and dated 12/17/2020 has revealed that there are 2 Cortese sites within approximately 0.5 miles of the target property.

EXECUTIVE SUMMARY

<u>Lower Elevation</u>	<u>Address</u>	<u>Direction / Distance</u>	<u>Map ID</u>	<u>Page</u>
CAL MAT FACILITY Cleanup Status: COMPLETED - CASE CLOSED	454 PROSPECT	SW 1/4 - 1/2 (0.305 mi.)	E24	55
EL MODENA HIGH SCHOO Cleanup Status: COMPLETED - CASE CLOSED	3920 E SPRING	SSE 1/4 - 1/2 (0.461 mi.)	G31	81

HIST CORTESE: The sites for the list are designated by the State Water Resource Control Board [LUST], the Integrated Waste Board [SWF/LS], and the Department of Toxic Substances Control [CALSTATES]. This listing is no longer updated by the state agency.

A review of the HIST CORTESE list, as provided by EDR, and dated 04/01/2001 has revealed that there are 2 HIST CORTESE sites within approximately 0.5 miles of the target property.

<u>Lower Elevation</u>	<u>Address</u>	<u>Direction / Distance</u>	<u>Map ID</u>	<u>Page</u>
CAL-MAT COMPANY Reg Id: 083000928T	454 PROSPECT	SW 1/4 - 1/2 (0.309 mi.)	E25	57
EL MODENA HIGH SCHOO Reg Id: 083001191T	3920 SPRING ST	SSE 1/4 - 1/2 (0.461 mi.)	G30	77

EXECUTIVE SUMMARY

There were no unmapped sites in this report.

OVERVIEW MAP - 6531282.2S

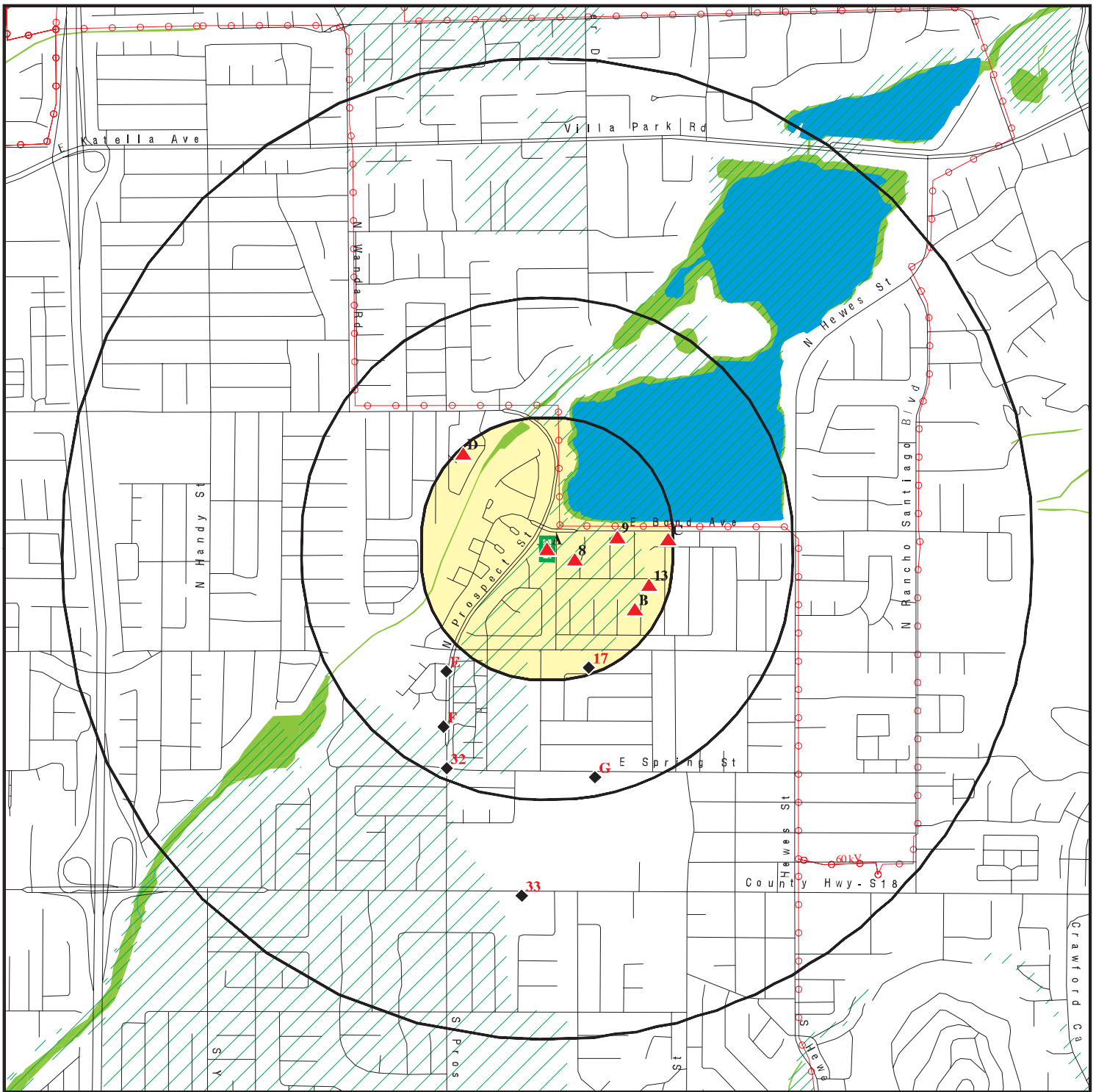

Target Property

Sites at elevations higher than or equal to the target property

Sites at elevations lower than the target property

Manufactured Gas Plants

National Priority List Sites

Dept. Defense Sites

Indian Reservations BIA

Power transmission lines

Special Flood Hazard Area (1%)

0.2% Annual Chance Flood Hazard

National Wetland Inventory

State Wetlands

Areas of Concern

0 1/4 1/2 1 Miles



This report includes Interactive Map Layers to display and/or hide map information. The legend includes only those icons for the default map view.

SITE NAME: Orange Park Acres Well Replacement Project
 ADDRESS: 678 North Gravier Street
 Orange CA 92869
 LAT/LONG: 33.798158 / 117.81472

CLIENT: Psomas
 CONTACT: Janet Powell
 INQUIRY #: 6531282.2s
 DATE: June 10, 2021 4:05 pm

DETAIL MAP - 6531282.2S



Target Property

Sites at elevations higher than or equal to the target property

Sites at elevations lower than the target property

Manufactured Gas Plants

Sensitive Receptors

National Priority List Sites

Dept. Defense Sites

Indian Reservations BIA

Power transmission lines

Special Flood Hazard Area (1%)

0.2% Annual Chance Flood Hazard

National Wetland Inventory

State Wetlands

Areas of Concern



This report includes Interactive Map Layers to display and/or hide map information. The legend includes only those icons for the default map view.

SITE NAME: Orange Park Acres Well Replacement Project
 ADDRESS: 678 North Gravier Street
 Orange CA 92869
 LAT/LONG: 33.798158 / 117.81472

CLIENT: Psomas
 CONTACT: Janet Powell
 INQUIRY #: 6531282.2s
 DATE: June 10, 2021 4:06 pm

MAP FINDINGS SUMMARY

Database	Search Distance (Miles)	Target Property	< 1/8	1/8 - 1/4	1/4 - 1/2	1/2 - 1	> 1	Total Plotted
STANDARD ENVIRONMENTAL RECORDS								
<i>Federal NPL site list</i>								
NPL	1.000		0	0	0	0	NR	0
Proposed NPL	1.000		0	0	0	0	NR	0
NPL LIENS	1.000		0	0	0	0	NR	0
<i>Federal Delisted NPL site list</i>								
Delisted NPL	1.000		0	0	0	0	NR	0
<i>Federal CERCLIS list</i>								
FEDERAL FACILITY	0.500		0	0	0	NR	NR	0
SEMS	0.500		0	0	0	NR	NR	0
<i>Federal CERCLIS NFRAP site list</i>								
SEMS-ARCHIVE	0.500		0	0	0	NR	NR	0
<i>Federal RCRA CORRACTS facilities list</i>								
CORRACTS	1.000		0	0	0	0	NR	0
<i>Federal RCRA non-CORRACTS TSD facilities list</i>								
RCRA-TSDF	0.500		0	0	0	NR	NR	0
<i>Federal RCRA generators list</i>								
RCRA-LQG	0.250		0	0	NR	NR	NR	0
RCRA-SQG	0.250		0	0	NR	NR	NR	0
RCRA-VSQG	0.250		0	0	NR	NR	NR	0
<i>Federal institutional controls / engineering controls registries</i>								
LUCIS	0.500		0	0	0	NR	NR	0
US ENG CONTROLS	0.500		0	0	0	NR	NR	0
US INST CONTROLS	0.500		0	0	0	NR	NR	0
<i>Federal ERNS list</i>								
ERNS	0.001		0	NR	NR	NR	NR	0
<i>State- and tribal - equivalent NPL RESPONSE</i>								
RESPONSE	1.000		0	0	0	0	NR	0
<i>State- and tribal - equivalent CERCLIS ENVIROSTOR</i>								
ENVIROSTOR	1.000		0	0	0	1	NR	1
<i>State and tribal landfill and/or solid waste disposal site lists</i>								
SWF/LF	0.500		0	0	1	NR	NR	1
<i>State and tribal leaking storage tank lists</i>								
LUST	0.500		0	0	5	NR	NR	5

MAP FINDINGS SUMMARY

Database	Search Distance (Miles)	Target Property	< 1/8	1/8 - 1/4	1/4 - 1/2	1/2 - 1	> 1	Total Plotted
INDIAN LUST	0.500		0	0	0	NR	NR	0
CPS-SLIC	0.500		0	0	1	NR	NR	1
<i>State and tribal registered storage tank lists</i>								
FEMA UST	0.250		0	0	NR	NR	NR	0
UST	0.250		0	0	NR	NR	NR	0
AST	0.250		0	0	NR	NR	NR	0
INDIAN UST	0.250		0	0	NR	NR	NR	0
<i>State and tribal voluntary cleanup sites</i>								
INDIAN VCP	0.500		0	0	0	NR	NR	0
VCP	0.500		0	0	0	NR	NR	0
<i>State and tribal Brownfields sites</i>								
BROWNFIELDS	0.500		0	0	0	NR	NR	0
<u>ADDITIONAL ENVIRONMENTAL RECORDS</u>								
<i>Local Brownfield lists</i>								
US BROWNFIELDS	0.500		0	0	1	NR	NR	1
<i>Local Lists of Landfill / Solid Waste Disposal Sites</i>								
WMUDS/SWAT	0.500		0	0	0	NR	NR	0
SWRCY	0.500		0	0	0	NR	NR	0
HAULERS	0.001		0	NR	NR	NR	NR	0
INDIAN ODI	0.500		0	0	0	NR	NR	0
ODI	0.500		0	0	0	NR	NR	0
DEBRIS REGION 9	0.500		0	0	0	NR	NR	0
IHS OPEN DUMPS	0.500		0	0	0	NR	NR	0
<i>Local Lists of Hazardous waste / Contaminated Sites</i>								
US HIST CDL	0.001		0	NR	NR	NR	NR	0
HIST Cal-Sites	1.000		0	0	0	0	NR	0
SCH	0.250		0	0	NR	NR	NR	0
CDL	0.001		0	NR	NR	NR	NR	0
Toxic Pits	1.000		0	0	0	0	NR	0
CERS HAZ WASTE	0.250		0	0	NR	NR	NR	0
US CDL	0.001		0	NR	NR	NR	NR	0
PFAS	0.500		0	0	0	NR	NR	0
<i>Local Lists of Registered Storage Tanks</i>								
SWEEPS UST	0.250		0	0	NR	NR	NR	0
HIST UST	0.250		0	0	NR	NR	NR	0
CA FID UST	0.250		0	0	NR	NR	NR	0
CERS TANKS	0.250		0	0	NR	NR	NR	0
<i>Local Land Records</i>								
LIENS	0.001		0	NR	NR	NR	NR	0

MAP FINDINGS SUMMARY

Database	Search Distance (Miles)	Target Property	< 1/8	1/8 - 1/4	1/4 - 1/2	1/2 - 1	> 1	Total Plotted
LIENS 2	0.001		0	NR	NR	NR	NR	0
DEED	0.500		0	0	0	NR	NR	0
Records of Emergency Release Reports								
HMIRS	0.001		0	NR	NR	NR	NR	0
CHMIRS	0.001		0	NR	NR	NR	NR	0
LDS	0.001		0	NR	NR	NR	NR	0
MCS	0.001		0	NR	NR	NR	NR	0
Orange Co. Industrial Site	0.001		0	NR	NR	NR	NR	0
SPILLS 90	0.001		0	NR	NR	NR	NR	0
Other Ascertainable Records								
RCRA NonGen / NLR	0.250		1	15	NR	NR	NR	16
FUDS	1.000		0	0	0	0	NR	0
DOD	1.000		0	0	0	0	NR	0
SCRD DRYCLEANERS	0.500		0	0	0	NR	NR	0
US FIN ASSUR	0.001		0	NR	NR	NR	NR	0
EPA WATCH LIST	0.001		0	NR	NR	NR	NR	0
2020 COR ACTION	0.250		0	0	NR	NR	NR	0
TSCA	0.001		0	NR	NR	NR	NR	0
TRIS	0.001		0	NR	NR	NR	NR	0
SSTS	0.001		0	NR	NR	NR	NR	0
ROD	1.000		0	0	0	0	NR	0
RMP	0.001		0	NR	NR	NR	NR	0
RAATS	0.001		0	NR	NR	NR	NR	0
PRP	0.001		0	NR	NR	NR	NR	0
PADS	0.001		0	NR	NR	NR	NR	0
ICIS	0.001		0	NR	NR	NR	NR	0
FTTS	0.001		0	NR	NR	NR	NR	0
MLTS	0.001		0	NR	NR	NR	NR	0
COAL ASH DOE	0.001		0	NR	NR	NR	NR	0
COAL ASH EPA	0.500		0	0	0	NR	NR	0
PCB TRANSFORMER	0.001		0	NR	NR	NR	NR	0
RADINFO	0.001		0	NR	NR	NR	NR	0
HIST FTTS	0.001		0	NR	NR	NR	NR	0
DOT OPS	0.001		0	NR	NR	NR	NR	0
CONSENT	1.000		0	0	0	0	NR	0
INDIAN RESERV	1.000		0	0	0	0	NR	0
FUSRAP	1.000		0	0	0	0	NR	0
UMTRA	0.500		0	0	0	NR	NR	0
LEAD SMELTERS	0.001		0	NR	NR	NR	NR	0
US AIRS	0.001		0	NR	NR	NR	NR	0
US MINES	0.250		0	0	NR	NR	NR	0
ABANDONED MINES	0.250		0	0	NR	NR	NR	0
FINDS	0.001	2	0	NR	NR	NR	NR	2
UXO	1.000		0	0	0	0	NR	0
ECHO	0.001		1	NR	NR	NR	NR	1
DOCKET HWC	0.001		0	NR	NR	NR	NR	0
FUELS PROGRAM	0.250		0	0	NR	NR	NR	0
CA BOND EXP. PLAN	1.000		0	0	0	0	NR	0
Cortese	0.500		0	0	2	NR	NR	2

MAP FINDINGS SUMMARY

<u>Database</u>	<u>Search Distance (Miles)</u>	<u>Target Property</u>	<u>< 1/8</u>	<u>1/8 - 1/4</u>	<u>1/4 - 1/2</u>	<u>1/2 - 1</u>	<u>> 1</u>	<u>Total Plotted</u>
-----------------	--	----------------------------	-----------------	------------------	------------------	----------------	---------------	--------------------------

NOTES:

TP = Target Property

NR = Not Requested at this Search Distance

Sites may be listed in more than one database

Map ID
Direction
Distance
Elevation

MAP FINDINGS

Site

Database(s) EDR ID Number
EPA ID Number

A1 IRWD OPA-1
Target 678 NORTH GRAVIER STREET
Property ORANGE, CA 92869

CIWQS S121646559
N/A

Site 1 of 7 in cluster A

Actual:
298 ft.

CIWQS:
Name: IRWD OPA-1
Address: 678 NORTH GRAVIER STREET
City,State,Zip: ORANGE, CA 92869
Agency: Best Drilling & Pump Inc
Agency Address: 1640 West Pellisier Road, Colton, CA 92324
Place/Project Type: Utility Structure
SIC/NAICS: Not reported
Region: 8
Program: NPDNONMUNIPRCS
Regulatory Measure Status: Historical
Regulatory Measure Type: Enrollee
Order Number: R8-2009-0003
WDID: 8 303600001
NPDES Number: CAG998001
Adoption Date: 01/01/1900
Effective Date: 08/21/2012
Termination Date: 09/03/2013
Expiration/Review Date: 03/01/2014
Design Flow: Not reported
Major/Minor: Not reported
Complexity: Not reported
TTWQ: Not reported
Enforcement Actions within 5 years: 0
Violations within 5 years: 0
Latitude: 33.801453
Longitude: -117.815828

A2 IRWD OPA-1
Target 678 GRAVIER
Property ORANGE, CA 92869

CERS S123511342
N/A

Site 2 of 7 in cluster A

Actual:
298 ft.

CERS:
Name: IRWD OPA-1
Address: 678 GRAVIER
City,State,Zip: ORANGE, CA 92869
Site ID: 351382
CERS ID: 785177
CERS Description: NPDES Wastewater and Stormwater
Affiliation:
Affiliation Type Desc: Operator
Entity Name: Best Drilling & Pump Inc
Entity Title: Not reported
Affiliation Address: Not reported
Affiliation City: Not reported
Affiliation State: Not reported
Affiliation Country: Not reported
Affiliation Zip: Not reported
Affiliation Phone: Not reported

MAP FINDINGS

Map ID
Direction
Distance
Elevation

Site

Database(s)

EDR ID Number
EPA ID Number

**A3
Target
Property**

**IRWD - OPA 1 WELL
678 GRAVIER
ORANGE, CA 92869**

**CERS S123516846
N/A**

Site 3 of 7 in cluster A

**Actual:
298 ft.**

CERS:

Name: IRWD - OPA 1 WELL
Address: 678 GRAVIER
City,State,Zip: ORANGE, CA 92869
Site ID: 408636
CERS ID: 10583623
CERS Description: Chemical Storage Facilities

Violations:

Site ID: 408636
Site Name: IRWD - OPA 1 WELL
Violation Date: 03-26-2018
Citation: HSC 6.95 25508(a)(1) - California Health and Safety Code, Chapter 6.95, Section(s) 25508(a)(1)
Violation Description: Failure to annually review and electronically certify that the business plan is complete and accurate on or before the annual due date.
Violation Notes: Returned to compliance on 09/13/2018.
Violation Division: Orange City Fire Department
Violation Program: HMRRP
Violation Source: CERS

Site ID: 408636
Site Name: IRWD - OPA 1 WELL
Violation Date: 10-13-2016
Citation: HSC 6.95 25508(a)(1) - California Health and Safety Code, Chapter 6.95, Section(s) 25508(a)(1)
Violation Description: Failure to complete and electronically submit a business plan when storing/handling a hazardous material at or above reportable quantities.
Violation Notes: Returned to compliance on 10/18/2016.
Violation Division: Orange City Fire Department
Violation Program: HMRRP
Violation Source: CERS

Evaluation:

Eval General Type: Other/Unknown
Eval Date: 03-26-2018
Violations Found: Yes
Eval Type: Other, not routine, done by local agency
Eval Notes: NOV letter mailed
Eval Division: Orange City Fire Department
Eval Program: HMRRP
Eval Source: CERS

Eval General Type: Compliance Evaluation Inspection
Eval Date: 10-13-2016
Violations Found: Yes
Eval Type: Routine done by local agency
Eval Notes: Not reported
Eval Division: Orange City Fire Department
Eval Program: HMRRP
Eval Source: CERS

Map ID
Direction
Distance
Elevation

MAP FINDINGS

Site

Database(s)

EDR ID Number
EPA ID Number

IRWD - OPA 1 WELL (Continued)

S123516846

Eval General Type: Compliance Evaluation Inspection
Eval Date: 12-09-2019
Violations Found: No
Eval Type: Routine done by local agency
Eval Notes: field verification.
Eval Division: Orange City Fire Department
Eval Program: HMRRP
Eval Source: CERS

Affiliation:

Affiliation Type Desc: Environmental Contact
Entity Name: Emilyn B. Zuniga
Entity Title: Not reported
Affiliation Address: 3512 Michelson Dr
Affiliation City: Irvine
Affiliation State: CA
Affiliation Country: Not reported
Affiliation Zip: 92612
Affiliation Phone: Not reported

Affiliation Type Desc: Identification Signer
Entity Name: Sunny Lee
Entity Title: Safety and Security Specialist
Affiliation Address: Not reported
Affiliation City: Not reported
Affiliation State: Not reported
Affiliation Country: Not reported
Affiliation Zip: Not reported
Affiliation Phone: Not reported

Affiliation Type Desc: Legal Owner
Entity Name: Irvine Ranch Water District
Entity Title: Not reported
Affiliation Address: 3512 Michelson Dr
Affiliation City: Irvine
Affiliation State: CA
Affiliation Country: United States
Affiliation Zip: 95612
Affiliation Phone: (949) 453-5300

Affiliation Type Desc: Parent Corporation
Entity Name: Irvine Ranch Water District
Entity Title: Not reported
Affiliation Address: Not reported
Affiliation City: Not reported
Affiliation State: Not reported
Affiliation Country: Not reported
Affiliation Zip: Not reported
Affiliation Phone: Not reported

Affiliation Type Desc: CUPA District
Entity Name: Orange County Env Health
Entity Title: Not reported
Affiliation Address: 1241 East Dyer Road Suite 120
Affiliation City: Santa Ana
Affiliation State: CA
Affiliation Country: Not reported

Map ID
 Direction
 Distance
 Elevation

MAP FINDINGS

Site

Database(s)

EDR ID Number
 EPA ID Number

IRWD - OPA 1 WELL (Continued)

S123516846

Affiliation Zip: 92705-5611
 Affiliation Phone: (714) 433-6406

Affiliation Type Desc: Document Preparer
 Entity Name: Bob Meripol
 Entity Title: Not reported
 Affiliation Address: Not reported
 Affiliation City: Not reported
 Affiliation State: Not reported
 Affiliation Country: Not reported
 Affiliation Zip: Not reported
 Affiliation Phone: Not reported

Affiliation Type Desc: Facility Mailing Address
 Entity Name: Mailing Address
 Entity Title: Not reported
 Affiliation Address: 3512 Michelson Dr
 Affiliation City: Irvine
 Affiliation State: CA
 Affiliation Country: Not reported
 Affiliation Zip: 92612
 Affiliation Phone: Not reported

Affiliation Type Desc: Operator
 Entity Name: Irvine Ranch Water District
 Entity Title: Not reported
 Affiliation Address: Not reported
 Affiliation City: Not reported
 Affiliation State: Not reported
 Affiliation Country: Not reported
 Affiliation Zip: Not reported
 Affiliation Phone: (949) 453-5300

A4 **IRVINE RANCH WATER DISTRICT**
Target **678 N GRAVIER ST**
Property **ORANGE, CA 92869**

HAZNET **S112973271**
HWTS **N/A**

Site 4 of 7 in cluster A

Actual:
298 ft.

HAZNET:
 Name: IRVINE RANCH WATER DISTRICT
 Address: 678 N GRAVIER ST
 Address 2: Not reported
 City,State,Zip: ORANGE, CA 92869
 Contact: RICHARD BROWN
 Telephone: 9494535788
 Mailing Name: Not reported
 Mailing Address: 3512 MICHELSON DR

Year: 2008
 Gepaid: CAC002635139
 TSD EPA ID: CAD099452708
 CA Waste Code: 221 - Waste oil and mixed oil
 Disposal Method: H039 - Other Recovery Of Reclamation For Reuse Including Acid
 Regeneration, Organics Recovery Ect
 Tons: 1.9

Map ID
Direction
Distance
Elevation

MAP FINDINGS

Site

Database(s)

EDR ID Number
EPA ID Number

IRVINE RANCH WATER DISTRICT (Continued)

S112973271

Year: 2008
Gepaid: CAC002635139
TSD EPA ID: Not reported
CA Waste Code: 221 - Waste oil and mixed oil
Disposal Method: H135 - Discharge To Sewer/Potw Or Npdes(With Prior Storage--With Or Without Treatment)
Tons: 0.57

Year: 2008
Gepaid: CAC002635139
TSD EPA ID: Not reported
CA Waste Code: 221 - Waste oil and mixed oil
Disposal Method: H135 - Discharge To Sewer/Potw Or Npdes(With Prior Storage--With Or Without Treatment)
Tons: 0.57

Additional Info:

Year: 2008
Gen EPA ID: CAC002635139

Shipment Date: 20080926
Creation Date: 11/3/2008 18:30:18
Receipt Date: 20080926
Manifest ID: 000765972JJK
Trans EPA ID: CAD983608258
Trans Name: OCEAN BLUE ENVIRONMENTAL
Trans 2 EPA ID: Not reported
Trans 2 Name: Not reported
TSD EPA ID: CAD099452708
Trans Name: INDUSTRIAL SERVICE OIL
TSD Alt EPA ID: Not reported
TSD Alt Name: Not reported
Waste Code Description: 221 - Waste oil and mixed oil
RCRA Code: Not reported
Meth Code: H039 - Other Recovery Of Reclamation For Reuse Including Acid Regeneration, Organics Recovery Ect
Quantity Tons: 1.9
Waste Quantity: 500
Quantity Unit: G
Additional Code 1: Not reported
Additional Code 2: Not reported
Additional Code 3: Not reported
Additional Code 4: Not reported
Additional Code 5: Not reported

Shipment Date: 20080926
Creation Date: 11/3/2008 18:30:40
Receipt Date: 20080930
Manifest ID: 004460608JJK
Trans EPA ID: CAD983608258
Trans Name: OCEAN BLUE ENVIRONMENTAL SERVICES
Trans 2 EPA ID: Not reported
Trans 2 Name: Not reported
TSD EPA ID: Not reported
Trans Name: CROSBY & OVERTON
TSD Alt EPA ID: Not reported

Map ID
Direction
Distance
Elevation

MAP FINDINGS

Site

Database(s)

EDR ID Number
EPA ID Number

IRVINE RANCH WATER DISTRICT (Continued)

S112973271

TSDF Alt Name: Not reported
Waste Code Description: 221 - Waste oil and mixed oil
RCRA Code: Not reported
Meth Code: H135 - Discharge To Sewer/Potw Or Npdes(With Prior Storage--With Or Without Treatment)
Quantity Tons: 0.57
Waste Quantity: 150
Quantity Unit: G
Additional Code 1: Not reported
Additional Code 2: Not reported
Additional Code 3: Not reported
Additional Code 4: Not reported
Additional Code 5: Not reported

HWTS:

Name: IRVINE RANCH WATER DISTRICT
Address: 678 N GRAVIER ST
Address 2: Not reported
City,State,Zip: ORANGE, CA 92869
EPA ID: CAC002635139
Inactive Date: 03/26/2009
Create Date: 09/26/2008
Last Act Date: 04/08/2009
Mailing Name: Not reported
Mailing Address: 3512 MICHELSON DR
Mailing Address 2: Not reported
Mailing City,State,Zip: IRVINE, CA 926121757
Owner Name: IRVINE RANCH WATER DISTRICT
Owner Address: 3512 MICHELSON DR
Owner Address 2: Not reported
Owner City,State,Zip: IRVINE, CA 926121757
Contact Name: RICHARD BROWN
Contact Address: 3512 MICHELSON DR
Contact Address 2: Not reported
City,State,Zip: IRVINE, CA 926121757

**A5
Target
Property**

**ORANGE PARK ACRES MWC-WELL 03 CHLORINATION - INACT
678 NORTH GRAVIER STREET
ORANGE, CA 92669**

**FINDS 1026277309
N/A**

Site 5 of 7 in cluster A

**Actual:
298 ft.**

FINDS:
Registry ID: 110050222610

Click Here:

Environmental Interest/Information System:
WATER TREATMENT PLANT

Click this hyperlink while viewing on your computer to access additional FINDS: detail in the EDR Site Report.

MAP FINDINGS

Map ID Direction Distance Elevation		Database(s)	EDR ID Number EPA ID Number
--	--	-------------	--------------------------------

A6 Target Property	IRWD OPA-1 678 GRAVIER ORANGE, CA 92869	FINDS	1023247698 N/A
---------------------------------	--	--------------	---------------------------------

Site 6 of 7 in cluster A

Actual: FINDS:
298 ft. Registry ID: 110065360709

Click Here:

Environmental Interest/Information System:
STATE MASTER

Click this hyperlink while viewing on your computer to access
additional FINDS: detail in the EDR Site Report.

A7 < 1/8 1 ft.	ORANGE PARK ACRES MWC ORANGE, CA 92869	ECHO	1008041605 N/A
--	---	-------------	---------------------------------

Site 7 of 7 in cluster A

Relative: Higher Actual: 299 ft.	ECHO: Envid: 1008041605 Registry ID: 110013152300 DFR URL: http://echo.epa.gov/detailed-facility-report?fid=110013152300 Name: ORANGE PARK ACRES MWC Address: Not reported City,State,Zip: ORANGE, CA 92869
---	--

8 ESE < 1/8 0.045 mi. 236 ft.	MAC MORANTE 650 N JAMES ST ORANGE, CA 92869	RCRA NonGen / NLR	1024772818 CAC002992735
---	--	--------------------------	--

Relative: Higher Actual: 301 ft.	RCRA NonGen / NLR: Date Form Received by Agency: 2018-12-12 00:00:00.0 Handler Name: MAC MORANTE Handler Address: 650 N JAMES ST Handler City,State,Zip: ORANGE, CA 92869 EPA ID: CAC002992735 Contact Name: MAC MORANTE Contact Address: 650 N JAMES ST Contact City,State,Zip: ORANGE, CA 92869 Contact Telephone: 714-803-0071 Contact Fax: Not reported Contact Email: MANIFEST.SIRRIS@GMAIL.COM Contact Title: Not reported EPA Region: 09 Land Type: Not reported Federal Waste Generator Description: Not a generator, verified Non-Notifier: Not reported Biennial Report Cycle: Not reported Accessibility: Not reported Active Site Indicator: Handler Activities State District Owner: Not reported State District: Not reported Mailing Address: 650 N JAMES ST
---	--

Map ID
 Direction
 Distance
 Elevation

MAP FINDINGS

Site

Database(s)

EDR ID Number
 EPA ID Number

MAC MORANTE (Continued)

1024772818

Mailing City,State,Zip:	ORANGE, CA 92869
Owner Name:	MAC MORANTE
Owner Type:	Other
Operator Name:	MAC MORANTE
Operator Type:	Other
Short-Term Generator Activity:	No
Importer Activity:	No
Mixed Waste Generator:	No
Transporter Activity:	No
Transfer Facility Activity:	No
Recycler Activity with Storage:	No
Small Quantity On-Site Burner Exemption:	No
Smelting Melting and Refining Furnace Exemption:	No
Underground Injection Control:	No
Off-Site Waste Receipt:	No
Universal Waste Indicator:	Yes
Universal Waste Destination Facility:	Yes
Federal Universal Waste:	No
Active Site Fed-Reg Treatment Storage and Disposal Facility:	Not reported
Active Site Converter Treatment storage and Disposal Facility:	Not reported
Active Site State-Reg Treatment Storage and Disposal Facility:	Not reported
Active Site State-Reg Handler:	---
Federal Facility Indicator:	Not reported
Hazardous Secondary Material Indicator:	N
Sub-Part K Indicator:	Not reported
Commercial TSD Indicator:	No
Treatment Storage and Disposal Type:	Not reported
2018 GPRA Permit Baseline:	Not on the Baseline
2018 GPRA Renewals Baseline:	Not on the Baseline
Permit Renewals Workload Universe:	Not reported
Permit Workload Universe:	Not reported
Permit Progress Universe:	Not reported
Post-Closure Workload Universe:	Not reported
Closure Workload Universe:	Not reported
202 GPRA Corrective Action Baseline:	No
Corrective Action Workload Universe:	No
Subject to Corrective Action Universe:	No
Non-TSDFs Where RCRA CA has Been Imposed Universe:	No
TSDFs Potentially Subject to CA Under 3004 (u)/(v) Universe:	No
TSDFs Only Subject to CA under Discretionary Auth Universe:	No
Corrective Action Priority Ranking:	No NCAPS ranking
Environmental Control Indicator:	No
Institutional Control Indicator:	No
Human Exposure Controls Indicator:	N/A
Groundwater Controls Indicator:	N/A
Operating TSDF Universe:	Not reported
Full Enforcement Universe:	Not reported
Significant Non-Complier Universe:	No
Unaddressed Significant Non-Complier Universe:	No
Addressed Significant Non-Complier Universe:	No
Significant Non-Complier With a Compliance Schedule Universe:	No
Financial Assurance Required:	Not reported
Handler Date of Last Change:	2018-12-20 13:52:23.0
Recognized Trader-Importer:	No
Recognized Trader-Exporter:	No
Importer of Spent Lead Acid Batteries:	No
Exporter of Spent Lead Acid Batteries:	No

Map ID
Direction
Distance
Elevation

MAP FINDINGS

Site

Database(s)

EDR ID Number
EPA ID Number

MAC MORANTE (Continued)

1024772818

Recycler Activity Without Storage: No
Manifest Broker: No
Sub-Part P Indicator: No

Handler - Owner Operator:

Owner/Operator Indicator: Owner
Owner/Operator Name: MAC MORANTE
Legal Status: Other
Date Became Current: Not reported
Date Ended Current: Not reported
Owner/Operator Address: 650 N JAMES ST
Owner/Operator City,State,Zip: ORANGE, CA 92869
Owner/Operator Telephone: 714-803-0071
Owner/Operator Telephone Ext: Not reported
Owner/Operator Fax: Not reported
Owner/Operator Email: Not reported

Owner/Operator Indicator: Operator
Owner/Operator Name: MAC MORANTE
Legal Status: Other
Date Became Current: Not reported
Date Ended Current: Not reported
Owner/Operator Address: 650 N JAMES ST
Owner/Operator City,State,Zip: ORANGE, CA 92869
Owner/Operator Telephone: 714-803-0071
Owner/Operator Telephone Ext: Not reported
Owner/Operator Fax: Not reported
Owner/Operator Email: Not reported

Historic Generators:

Receive Date: 2018-12-12 00:00:00.0
Handler Name: MAC MORANTE
Federal Waste Generator Description: Not a generator, verified
State District Owner: Not reported
Large Quantity Handler of Universal Waste: No
Recognized Trader Importer: No
Recognized Trader Exporter: No
Spent Lead Acid Battery Importer: No
Spent Lead Acid Battery Exporter: No
Current Record: Yes
Non Storage Recycler Activity: Not reported
Electronic Manifest Broker: Not reported

List of NAICS Codes and Descriptions:

NAICS Code: 56299
NAICS Description: ALL OTHER WASTE MANAGEMENT SERVICES

Facility Has Received Notices of Violations:

Violations: No Violations Found

Evaluation Action Summary:

Evaluations: No Evaluations Found

Map ID
 Direction
 Distance
 Elevation

MAP FINDINGS

Site

Database(s)

EDR ID Number
 EPA ID Number

9
East
1/8-1/4
0.133 mi.
704 ft.

KEVIN CARMODY
691 N LA NAE CIR
ORANGE, CA 92869

RCRA NonGen / NLR

1024749846
CAC002969634

Relative:
Higher
Actual:
306 ft.

RCRA NonGen / NLR:		2018-07-06 00:00:00.0
Date Form Received by Agency:		
Handler Name:	KEVIN CARMODY	
Handler Address:	691 N LA NAE CIR	
Handler City,State,Zip:	ORANGE, CA 92869	
EPA ID:	CAC002969634	
Contact Name:	KEVIN CARMODY	
Contact Address:	691 N LA NAE CIR	
Contact City,State,Zip:	ORANGE, CA 92869	
Contact Telephone:	714-717-4382	
Contact Fax:	Not reported	
Contact Email:	JOE@SIRRIS.BIZ	
Contact Title:	Not reported	
EPA Region:	09	
Land Type:	Not reported	
Federal Waste Generator Description:	Not a generator, verified	
Non-Notifier:	Not reported	
Biennial Report Cycle:	Not reported	
Accessibility:	Not reported	
Active Site Indicator:	Handler Activities	
State District Owner:	Not reported	
State District:	Not reported	
Mailing Address:	691 N LA NAE CIR	
Mailing City,State,Zip:	ORANGE, CA 92869	
Owner Name:	KEVIN CARMODY	
Owner Type:	Other	
Operator Name:	KEVIN CARMODY	
Operator Type:	Other	
Short-Term Generator Activity:	No	
Importer Activity:	No	
Mixed Waste Generator:	No	
Transporter Activity:	No	
Transfer Facility Activity:	No	
Recycler Activity with Storage:	No	
Small Quantity On-Site Burner Exemption:	No	
Smelting Melting and Refining Furnace Exemption:	No	
Underground Injection Control:	No	
Off-Site Waste Receipt:	No	
Universal Waste Indicator:	Yes	
Universal Waste Destination Facility:	Yes	
Federal Universal Waste:	No	
Active Site Fed-Reg Treatment Storage and Disposal Facility:	Not reported	
Active Site Converter Treatment storage and Disposal Facility:	Not reported	
Active Site State-Reg Treatment Storage and Disposal Facility:	Not reported	
Active Site State-Reg Handler:	---	
Federal Facility Indicator:	Not reported	
Hazardous Secondary Material Indicator:	N	
Sub-Part K Indicator:	Not reported	
Commercial TSD Indicator:	No	
Treatment Storage and Disposal Type:	Not reported	
2018 GPRA Permit Baseline:	Not on the Baseline	
2018 GPRA Renewals Baseline:	Not on the Baseline	
Permit Renewals Workload Universe:	Not reported	

Map ID
 Direction
 Distance
 Elevation

MAP FINDINGS

Site

Database(s)

EDR ID Number
 EPA ID Number

KEVIN CARMODY (Continued)

1024749846

Permit Workload Universe:	Not reported
Permit Progress Universe:	Not reported
Post-Closure Workload Universe:	Not reported
Closure Workload Universe:	Not reported
202 GPRA Corrective Action Baseline:	No
Corrective Action Workload Universe:	No
Subject to Corrective Action Universe:	No
Non-TSDFs Where RCRA CA has Been Imposed Universe:	No
TSDFs Potentially Subject to CA Under 3004 (u)/(v) Universe:	No
TSDFs Only Subject to CA under Discretionary Auth Universe:	No
Corrective Action Priority Ranking:	No NCAPS ranking
Environmental Control Indicator:	No
Institutional Control Indicator:	No
Human Exposure Controls Indicator:	N/A
Groundwater Controls Indicator:	N/A
Operating TSDF Universe:	Not reported
Full Enforcement Universe:	Not reported
Significant Non-Complier Universe:	No
Unaddressed Significant Non-Complier Universe:	No
Addressed Significant Non-Complier Universe:	No
Significant Non-Complier With a Compliance Schedule Universe:	No
Financial Assurance Required:	Not reported
Handler Date of Last Change:	2018-09-05 15:38:53.0
Recognized Trader-Importer:	No
Recognized Trader-Exporter:	No
Importer of Spent Lead Acid Batteries:	No
Exporter of Spent Lead Acid Batteries:	No
Recycler Activity Without Storage:	No
Manifest Broker:	No
Sub-Part P Indicator:	No

Handler - Owner Operator:

Owner/Operator Indicator:	Owner
Owner/Operator Name:	KEVIN CARMODY
Legal Status:	Other
Date Became Current:	Not reported
Date Ended Current:	Not reported
Owner/Operator Address:	691 N LA NAE CIR
Owner/Operator City,State,Zip:	ORANGE, CA 92869
Owner/Operator Telephone:	714-717-4382
Owner/Operator Telephone Ext:	Not reported
Owner/Operator Fax:	Not reported
Owner/Operator Email:	Not reported

Owner/Operator Indicator:	Operator
Owner/Operator Name:	KEVIN CARMODY
Legal Status:	Other
Date Became Current:	Not reported
Date Ended Current:	Not reported
Owner/Operator Address:	691 N LA NAE CIR
Owner/Operator City,State,Zip:	ORANGE, CA 92869
Owner/Operator Telephone:	714-717-4382
Owner/Operator Telephone Ext:	Not reported
Owner/Operator Fax:	Not reported
Owner/Operator Email:	Not reported

Map ID
Direction
Distance
Elevation

MAP FINDINGS

Site

Database(s)

EDR ID Number
EPA ID Number

KEVIN CARMODY (Continued)

1024749846

Historic Generators:

Receive Date: 2018-07-06 00:00:00.0
Handler Name: KEVIN CARMODY
Federal Waste Generator Description: Not a generator, verified
State District Owner: Not reported
Large Quantity Handler of Universal Waste: No
Recognized Trader Importer: No
Recognized Trader Exporter: No
Spent Lead Acid Battery Importer: No
Spent Lead Acid Battery Exporter: No
Current Record: Yes
Non Storage Recycler Activity: Not reported
Electronic Manifest Broker: Not reported

List of NAICS Codes and Descriptions:

NAICS Code: 56299
NAICS Description: ALL OTHER WASTE MANAGEMENT SERVICES

Facility Has Received Notices of Violations:

Violations: No Violations Found

Evaluation Action Summary:

Evaluations: No Evaluations Found

B10
SE
1/8-1/4
0.167 mi.
882 ft.

JOSE ESPARZA
558 N LA NAE CIR
ORANGE, CA 92869
Site 1 of 3 in cluster B

RCRA NonGen / NLR **1025840135**
CAC003019735

Relative:
Higher
Actual:
299 ft.

RCRA NonGen / NLR:
Date Form Received by Agency: 2019-06-14 00:00:00.0
Handler Name: JOSE ESPARZA
Handler Address: 558 N LA NAE CIR
Handler City,State,Zip: ORANGE, CA 92869
EPA ID: CAC003019735
Contact Name: JOSE ESPARZA
Contact Address: 558 N LA NAE CIR
Contact City,State,Zip: ORANGE, CA 92869
Contact Telephone: 714-978-7877
Contact Fax: Not reported
Contact Email: NANCYRUIZ@ALLIANCE-ENVIRO.COM
Contact Title: Not reported
EPA Region: 09
Land Type: Not reported
Federal Waste Generator Description: Not a generator, verified
Non-Notifier: Not reported
Biennial Report Cycle: Not reported
Accessibility: Not reported
Active Site Indicator: Handler Activities
State District Owner: Not reported
State District: Not reported
Mailing Address: 558 N LA NAE CIR
Mailing City,State,Zip: ORANGE, CA 92869
Owner Name: JOSE ESPARZA

Map ID
Direction
Distance
Elevation

MAP FINDINGS

Site

Database(s)

EDR ID Number
EPA ID Number

JOSE ESPARZA (Continued)

1025840135

Owner Type:	Other
Operator Name:	JOSE ESPARZA
Operator Type:	Other
Short-Term Generator Activity:	No
Importer Activity:	No
Mixed Waste Generator:	No
Transporter Activity:	No
Transfer Facility Activity:	No
Recycler Activity with Storage:	No
Small Quantity On-Site Burner Exemption:	No
Smelting Melting and Refining Furnace Exemption:	No
Underground Injection Control:	No
Off-Site Waste Receipt:	No
Universal Waste Indicator:	Yes
Universal Waste Destination Facility:	Yes
Federal Universal Waste:	No
Active Site Fed-Reg Treatment Storage and Disposal Facility:	Not reported
Active Site Converter Treatment storage and Disposal Facility:	Not reported
Active Site State-Reg Treatment Storage and Disposal Facility:	Not reported
Active Site State-Reg Handler:	---
Federal Facility Indicator:	Not reported
Hazardous Secondary Material Indicator:	N
Sub-Part K Indicator:	Not reported
Commercial TSD Indicator:	No
Treatment Storage and Disposal Type:	Not reported
2018 GPRA Permit Baseline:	Not on the Baseline
2018 GPRA Renewals Baseline:	Not on the Baseline
Permit Renewals Workload Universe:	Not reported
Permit Workload Universe:	Not reported
Permit Progress Universe:	Not reported
Post-Closure Workload Universe:	Not reported
Closure Workload Universe:	Not reported
202 GPRA Corrective Action Baseline:	No
Corrective Action Workload Universe:	No
Subject to Corrective Action Universe:	No
Non-TSDs Where RCRA CA has Been Imposed Universe:	No
TSDs Potentially Subject to CA Under 3004 (u)/(v) Universe:	No
TSDs Only Subject to CA under Discretionary Auth Universe:	No
Corrective Action Priority Ranking:	No NCAPS ranking
Environmental Control Indicator:	No
Institutional Control Indicator:	No
Human Exposure Controls Indicator:	N/A
Groundwater Controls Indicator:	N/A
Operating TSD Universe:	Not reported
Full Enforcement Universe:	Not reported
Significant Non-Complier Universe:	No
Unaddressed Significant Non-Complier Universe:	No
Addressed Significant Non-Complier Universe:	No
Significant Non-Complier With a Compliance Schedule Universe:	No
Financial Assurance Required:	Not reported
Handler Date of Last Change:	2019-06-27 14:19:59.0
Recognized Trader-Importer:	No
Recognized Trader-Exporter:	No
Importer of Spent Lead Acid Batteries:	No
Exporter of Spent Lead Acid Batteries:	No
Recycler Activity Without Storage:	No
Manifest Broker:	No

Map ID
Direction
Distance
Elevation

MAP FINDINGS

Site

Database(s)

EDR ID Number
EPA ID Number

JOSE ESPARZA (Continued)

1025840135

Sub-Part P Indicator: No

Handler - Owner Operator:
Owner/Operator Indicator: Owner
Owner/Operator Name: JOSE ESPARZA
Legal Status: Other
Date Became Current: Not reported
Date Ended Current: Not reported
Owner/Operator Address: 558 N LA NAE CIR
Owner/Operator City,State,Zip: ORANGE, CA 92869
Owner/Operator Telephone: 714-978-7877
Owner/Operator Telephone Ext: Not reported
Owner/Operator Fax: Not reported
Owner/Operator Email: Not reported

Owner/Operator Indicator: Operator
Owner/Operator Name: JOSE ESPARZA
Legal Status: Other
Date Became Current: Not reported
Date Ended Current: Not reported
Owner/Operator Address: 558 N LA NAE CIR
Owner/Operator City,State,Zip: ORANGE, CA 92869
Owner/Operator Telephone: 714-978-7877
Owner/Operator Telephone Ext: Not reported
Owner/Operator Fax: Not reported
Owner/Operator Email: Not reported

Historic Generators:
Receive Date: 2019-06-14 00:00:00.0
Handler Name: JOSE ESPARZA
Federal Waste Generator Description: Not a generator, verified
State District Owner: Not reported
Large Quantity Handler of Universal Waste: No
Recognized Trader Importer: No
Recognized Trader Exporter: No
Spent Lead Acid Battery Importer: No
Spent Lead Acid Battery Exporter: No
Current Record: Yes
Non Storage Recycler Activity: Not reported
Electronic Manifest Broker: Not reported

List of NAICS Codes and Descriptions:
NAICS Code: 56299
NAICS Description: ALL OTHER WASTE MANAGEMENT SERVICES

Facility Has Received Notices of Violations:
Violations: No Violations Found

Evaluation Action Summary:
Evaluations: No Evaluations Found

Map ID
 Direction
 Distance
 Elevation

MAP FINDINGS

EDR ID Number
 EPA ID Number

Map ID	Site	Database(s)	EDR ID Number
B11	BRET VINCENT	RCRA NonGen / NLR	1026719329
SE	557 NORTH LA NAE CIRCLE		CAC003107967
1/8-1/4	ORANGE, CA 92869		
0.186 mi.			
981 ft.	Site 2 of 3 in cluster B		
Relative:	RCRA NonGen / NLR:		
Higher	Date Form Received by Agency:	2021-03-02 00:00:00.0	
	Handler Name:	BRET VINCENT	
Actual:	Handler Address:	557 NORTH LA NAE CIRCLE	
300 ft.	Handler City,State,Zip:	ORANGE, CA 92869	
	EPA ID:	CAC003107967	
	Contact Name:	BRET VINCENT	
	Contact Address:	557 NORTH LA NAE CIRCLE	
	Contact City,State,Zip:	ORANGE, CA 92869	
	Contact Telephone:	714-357-2154	
	Contact Fax:	Not reported	
	Contact Email:	KARLA@SUPERIORENV.COM	
	Contact Title:	Not reported	
	EPA Region:	09	
	Land Type:	Not reported	
	Federal Waste Generator Description:	Not a generator, verified	
	Non-Notifier:	Not reported	
	Biennial Report Cycle:	Not reported	
	Accessibility:	Not reported	
	Active Site Indicator:	Not reported	
	State District Owner:	Not reported	
	State District:	Not reported	
	Mailing Address:	557 NORTH LA NAE CIRCLE	
	Mailing City,State,Zip:	ORANGE, CA 92869	
	Owner Name:	BRET VINCENT	
	Owner Type:	Other	
	Operator Name:	BRET VINCENT	
	Operator Type:	Other	
	Short-Term Generator Activity:	No	
	Importer Activity:	No	
	Mixed Waste Generator:	No	
	Transporter Activity:	No	
	Transfer Facility Activity:	No	
	Recycler Activity with Storage:	No	
	Small Quantity On-Site Burner Exemption:	No	
	Smelting Melting and Refining Furnace Exemption:	No	
	Underground Injection Control:	No	
	Off-Site Waste Receipt:	No	
	Universal Waste Indicator:	No	
	Universal Waste Destination Facility:	No	
	Federal Universal Waste:	No	
	Active Site Fed-Reg Treatment Storage and Disposal Facility:	Not reported	
	Active Site Converter Treatment storage and Disposal Facility:	Not reported	
	Active Site State-Reg Treatment Storage and Disposal Facility:	Not reported	
	Active Site State-Reg Handler:	---	
	Federal Facility Indicator:	Not reported	
	Hazardous Secondary Material Indicator:	N	
	Sub-Part K Indicator:	Not reported	
	Commercial TSD Indicator:	No	
	Treatment Storage and Disposal Type:	Not reported	
	2018 GPRA Permit Baseline:	Not on the Baseline	
	2018 GPRA Renewals Baseline:	Not on the Baseline	
	Permit Renewals Workload Universe:	Not reported	

Map ID
 Direction
 Distance
 Elevation

MAP FINDINGS

Site

Database(s)

EDR ID Number
 EPA ID Number

BRET VINCENT (Continued)

1026719329

Permit Workload Universe:	Not reported
Permit Progress Universe:	Not reported
Post-Closure Workload Universe:	Not reported
Closure Workload Universe:	Not reported
202 GPRA Corrective Action Baseline:	No
Corrective Action Workload Universe:	No
Subject to Corrective Action Universe:	No
Non-TSDFs Where RCRA CA has Been Imposed Universe:	No
TSDFs Potentially Subject to CA Under 3004 (u)/(v) Universe:	No
TSDFs Only Subject to CA under Discretionary Auth Universe:	No
Corrective Action Priority Ranking:	No NCAPS ranking
Environmental Control Indicator:	No
Institutional Control Indicator:	No
Human Exposure Controls Indicator:	N/A
Groundwater Controls Indicator:	N/A
Operating TSDF Universe:	Not reported
Full Enforcement Universe:	Not reported
Significant Non-Complier Universe:	No
Unaddressed Significant Non-Complier Universe:	No
Addressed Significant Non-Complier Universe:	No
Significant Non-Complier With a Compliance Schedule Universe:	No
Financial Assurance Required:	Not reported
Handler Date of Last Change:	2021-03-12 19:45:50.0
Recognized Trader-Importer:	No
Recognized Trader-Exporter:	No
Importer of Spent Lead Acid Batteries:	No
Exporter of Spent Lead Acid Batteries:	No
Recycler Activity Without Storage:	No
Manifest Broker:	No
Sub-Part P Indicator:	No

Handler - Owner Operator:

Owner/Operator Indicator:	Operator
Owner/Operator Name:	BRET VINCENT
Legal Status:	Other
Date Became Current:	Not reported
Date Ended Current:	Not reported
Owner/Operator Address:	557 NORTH LA NAE CIRCLE
Owner/Operator City,State,Zip:	ORANGE, CA 92869
Owner/Operator Telephone:	714-357-2154
Owner/Operator Telephone Ext:	Not reported
Owner/Operator Fax:	Not reported
Owner/Operator Email:	Not reported

Owner/Operator Indicator:	Owner
Owner/Operator Name:	BRET VINCENT
Legal Status:	Other
Date Became Current:	Not reported
Date Ended Current:	Not reported
Owner/Operator Address:	557 NORTH LA NAE CIRCLE
Owner/Operator City,State,Zip:	ORANGE, CA 92869
Owner/Operator Telephone:	714-357-2154
Owner/Operator Telephone Ext:	Not reported
Owner/Operator Fax:	Not reported
Owner/Operator Email:	Not reported

Map ID
Direction
Distance
Elevation

MAP FINDINGS

Site

Database(s)

EDR ID Number
EPA ID Number

BRET VINCENT (Continued)

1026719329

Historic Generators:

Receive Date: 2021-03-02 00:00:00.0
Handler Name: BRET VINCENT
Federal Waste Generator Description: Not a generator, verified
State District Owner: Not reported
Large Quantity Handler of Universal Waste: No
Recognized Trader Importer: No
Recognized Trader Exporter: No
Spent Lead Acid Battery Importer: No
Spent Lead Acid Battery Exporter: No
Current Record: Yes
Non Storage Recycler Activity: No
Electronic Manifest Broker: No

List of NAICS Codes and Descriptions:

NAICS Code: 56299
NAICS Description: ALL OTHER WASTE MANAGEMENT SERVICES

Facility Has Received Notices of Violations:

Violations: No Violations Found

Evaluation Action Summary:

Evaluations: No Evaluations Found

B12
SE
1/8-1/4
0.198 mi.
1047 ft.

SAM MAFFEY
568 N RICK ST
ORANGE, CA 92869

RCRA NonGen / NLR

1025855624
CAC003035901

Site 3 of 3 in cluster B

Relative:
Higher
Actual:
301 ft.

RCRA NonGen / NLR:
Date Form Received by Agency: 2019-09-26 00:00:00.0
Handler Name: SAM MAFFEY
Handler Address: 568 N RICK ST
Handler City,State,Zip: ORANGE, CA 92869
EPA ID: CAC003035901
Contact Name: SAM MAFFEY
Contact Address: 568 N RICK ST
Contact City,State,Zip: ORANGE, CA 92869
Contact Telephone: 714-312-8632
Contact Fax: Not reported
Contact Email: ANAB@PWSEI.COM
Contact Title: Not reported
EPA Region: 09
Land Type: Not reported
Federal Waste Generator Description: Not a generator, verified
Non-Notifier: Not reported
Biennial Report Cycle: Not reported
Accessibility: Not reported
Active Site Indicator: Not reported
State District Owner: Not reported
State District: Not reported
Mailing Address: 568 N RICK ST
Mailing City,State,Zip: ORANGE, CA 92869
Owner Name: SAM MAFFEY

Map ID
 Direction
 Distance
 Elevation

MAP FINDINGS

Site

Database(s)

EDR ID Number
 EPA ID Number

SAM MAFFEY (Continued)

1025855624

Owner Type:	Other
Operator Name:	SAM MAFFEY
Operator Type:	Other
Short-Term Generator Activity:	No
Importer Activity:	No
Mixed Waste Generator:	No
Transporter Activity:	No
Transfer Facility Activity:	No
Recycler Activity with Storage:	No
Small Quantity On-Site Burner Exemption:	No
Smelting Melting and Refining Furnace Exemption:	No
Underground Injection Control:	No
Off-Site Waste Receipt:	No
Universal Waste Indicator:	No
Universal Waste Destination Facility:	No
Federal Universal Waste:	No
Active Site Fed-Reg Treatment Storage and Disposal Facility:	Not reported
Active Site Converter Treatment storage and Disposal Facility:	Not reported
Active Site State-Reg Treatment Storage and Disposal Facility:	Not reported
Active Site State-Reg Handler:	---
Federal Facility Indicator:	Not reported
Hazardous Secondary Material Indicator:	N
Sub-Part K Indicator:	Not reported
Commercial TSD Indicator:	No
Treatment Storage and Disposal Type:	Not reported
2018 GPRA Permit Baseline:	Not on the Baseline
2018 GPRA Renewals Baseline:	Not on the Baseline
Permit Renewals Workload Universe:	Not reported
Permit Workload Universe:	Not reported
Permit Progress Universe:	Not reported
Post-Closure Workload Universe:	Not reported
Closure Workload Universe:	Not reported
202 GPRA Corrective Action Baseline:	No
Corrective Action Workload Universe:	No
Subject to Corrective Action Universe:	No
Non-TSDs Where RCRA CA has Been Imposed Universe:	No
TSDs Potentially Subject to CA Under 3004 (u)/(v) Universe:	No
TSDs Only Subject to CA under Discretionary Auth Universe:	No
Corrective Action Priority Ranking:	No NCAPS ranking
Environmental Control Indicator:	No
Institutional Control Indicator:	No
Human Exposure Controls Indicator:	N/A
Groundwater Controls Indicator:	N/A
Operating TSD Universe:	Not reported
Full Enforcement Universe:	Not reported
Significant Non-Complier Universe:	No
Unaddressed Significant Non-Complier Universe:	No
Addressed Significant Non-Complier Universe:	No
Significant Non-Complier With a Compliance Schedule Universe:	No
Financial Assurance Required:	Not reported
Handler Date of Last Change:	2019-09-27 16:23:43.0
Recognized Trader-Importer:	No
Recognized Trader-Exporter:	No
Importer of Spent Lead Acid Batteries:	No
Exporter of Spent Lead Acid Batteries:	No
Recycler Activity Without Storage:	No
Manifest Broker:	No

Map ID
Direction
Distance
Elevation

MAP FINDINGS

Site

Database(s)

EDR ID Number
EPA ID Number

SAM MAFFEY (Continued)

1025855624

Sub-Part P Indicator: No

Handler - Owner Operator:
Owner/Operator Indicator: Owner
Owner/Operator Name: SAM MAFFEY
Legal Status: Other
Date Became Current: Not reported
Date Ended Current: Not reported
Owner/Operator Address: 568 N RICK ST
Owner/Operator City,State,Zip: ORANGE, CA 92869
Owner/Operator Telephone: 714-312-8632
Owner/Operator Telephone Ext: Not reported
Owner/Operator Fax: Not reported
Owner/Operator Email: Not reported

Owner/Operator Indicator: Operator
Owner/Operator Name: SAM MAFFEY
Legal Status: Other
Date Became Current: Not reported
Date Ended Current: Not reported
Owner/Operator Address: 568 N RICK ST
Owner/Operator City,State,Zip: ORANGE, CA 92869
Owner/Operator Telephone: 714-312-8632
Owner/Operator Telephone Ext: Not reported
Owner/Operator Fax: Not reported
Owner/Operator Email: Not reported

Historic Generators:
Receive Date: 2019-09-26 00:00:00.0
Handler Name: SAM MAFFEY
Federal Waste Generator Description: Not a generator, verified
State District Owner: Not reported
Large Quantity Handler of Universal Waste: No
Recognized Trader Importer: No
Recognized Trader Exporter: No
Spent Lead Acid Battery Importer: No
Spent Lead Acid Battery Exporter: No
Current Record: Yes
Non Storage Recycler Activity: Not reported
Electronic Manifest Broker: Not reported

List of NAICS Codes and Descriptions:
NAICS Code: 56299
NAICS Description: ALL OTHER WASTE MANAGEMENT SERVICES

Facility Has Received Notices of Violations:
Violations: No Violations Found

Evaluation Action Summary:
Evaluations: No Evaluations Found

Map ID
 Direction
 Distance
 Elevation

MAP FINDINGS

Site

Database(s)

EDR ID Number
 EPA ID Number

13
ESE
1/8-1/4
0.207 mi.
1092 ft.

BILL COX
4002 E EL CARMEN AVE
ORANGE, CA 92869

RCRA NonGen / NLR

1026052613
CAC003059509

Relative:
Higher

RCRA NonGen / NLR:

Actual:
304 ft.

Date Form Received by Agency:	2020-03-11 00:00:00.0
Handler Name:	BILL COX
Handler Address:	4002 E EL CARMEN AVE
Handler City,State,Zip:	ORANGE, CA 92869-2641
EPA ID:	CAC003059509
Contact Name:	BILL COX
Contact Address:	4002 E EL CARMEN AVE
Contact City,State,Zip:	ORANGE, CA 92869-2641
Contact Telephone:	714-743-2092
Contact Fax:	Not reported
Contact Email:	MANIFEST.SIRRIS@GMAIL.COM
Contact Title:	Not reported
EPA Region:	09
Land Type:	Not reported
Federal Waste Generator Description:	Not a generator, verified
Non-Notifier:	Not reported
Biennial Report Cycle:	Not reported
Accessibility:	Not reported
Active Site Indicator:	Not reported
State District Owner:	Not reported
State District:	Not reported
Mailing Address:	4002 E EL CARMEN AVE
Mailing City,State,Zip:	ORANGE, CA 92869-2641
Owner Name:	BILL COX
Owner Type:	Other
Operator Name:	BILL COX
Operator Type:	Other
Short-Term Generator Activity:	No
Importer Activity:	No
Mixed Waste Generator:	No
Transporter Activity:	No
Transfer Facility Activity:	No
Recycler Activity with Storage:	No
Small Quantity On-Site Burner Exemption:	No
Smelting Melting and Refining Furnace Exemption:	No
Underground Injection Control:	No
Off-Site Waste Receipt:	No
Universal Waste Indicator:	No
Universal Waste Destination Facility:	No
Federal Universal Waste:	No
Active Site Fed-Reg Treatment Storage and Disposal Facility:	Not reported
Active Site Converter Treatment storage and Disposal Facility:	Not reported
Active Site State-Reg Treatment Storage and Disposal Facility:	Not reported
Active Site State-Reg Handler:	---
Federal Facility Indicator:	Not reported
Hazardous Secondary Material Indicator:	N
Sub-Part K Indicator:	Not reported
Commercial TSD Indicator:	No
Treatment Storage and Disposal Type:	Not reported
2018 GPRP Permit Baseline:	Not on the Baseline
2018 GPRP Renewals Baseline:	Not on the Baseline
Permit Renewals Workload Universe:	Not reported

Map ID
 Direction
 Distance
 Elevation

MAP FINDINGS

Site

Database(s)

EDR ID Number
 EPA ID Number

BILL COX (Continued)

1026052613

Permit Workload Universe:	Not reported
Permit Progress Universe:	Not reported
Post-Closure Workload Universe:	Not reported
Closure Workload Universe:	Not reported
202 GPRA Corrective Action Baseline:	No
Corrective Action Workload Universe:	No
Subject to Corrective Action Universe:	No
Non-TSDFs Where RCRA CA has Been Imposed Universe:	No
TSDFs Potentially Subject to CA Under 3004 (u)/(v) Universe:	No
TSDFs Only Subject to CA under Discretionary Auth Universe:	No
Corrective Action Priority Ranking:	No NCAPS ranking
Environmental Control Indicator:	No
Institutional Control Indicator:	No
Human Exposure Controls Indicator:	N/A
Groundwater Controls Indicator:	N/A
Operating TSDF Universe:	Not reported
Full Enforcement Universe:	Not reported
Significant Non-Complier Universe:	No
Unaddressed Significant Non-Complier Universe:	No
Addressed Significant Non-Complier Universe:	No
Significant Non-Complier With a Compliance Schedule Universe:	No
Financial Assurance Required:	Not reported
Handler Date of Last Change:	2020-03-13 17:51:45.0
Recognized Trader-Importer:	No
Recognized Trader-Exporter:	No
Importer of Spent Lead Acid Batteries:	No
Exporter of Spent Lead Acid Batteries:	No
Recycler Activity Without Storage:	No
Manifest Broker:	No
Sub-Part P Indicator:	No

Handler - Owner Operator:

Owner/Operator Indicator:	Owner
Owner/Operator Name:	BILL COX
Legal Status:	Other
Date Became Current:	Not reported
Date Ended Current:	Not reported
Owner/Operator Address:	4002 E EL CARMEN AVE
Owner/Operator City,State,Zip:	ORANGE, CA 92869-2641
Owner/Operator Telephone:	714-743-2092
Owner/Operator Telephone Ext:	Not reported
Owner/Operator Fax:	Not reported
Owner/Operator Email:	Not reported

Owner/Operator Indicator:	Operator
Owner/Operator Name:	BILL COX
Legal Status:	Other
Date Became Current:	Not reported
Date Ended Current:	Not reported
Owner/Operator Address:	4002 E EL CARMEN AVE
Owner/Operator City,State,Zip:	ORANGE, CA 92869-2641
Owner/Operator Telephone:	714-743-2092
Owner/Operator Telephone Ext:	Not reported
Owner/Operator Fax:	Not reported
Owner/Operator Email:	Not reported

Map ID
 Direction
 Distance
 Elevation

MAP FINDINGS

Site

Database(s)

EDR ID Number
 EPA ID Number

BILL COX (Continued)

1026052613

Historic Generators:

Receive Date:	2020-03-11 00:00:00.0
Handler Name:	BILL COX
Federal Waste Generator Description:	Not a generator, verified
State District Owner:	Not reported
Large Quantity Handler of Universal Waste:	No
Recognized Trader Importer:	No
Recognized Trader Exporter:	No
Spent Lead Acid Battery Importer:	No
Spent Lead Acid Battery Exporter:	No
Current Record:	Yes
Non Storage Recycler Activity:	Not reported
Electronic Manifest Broker:	Not reported

List of NAICS Codes and Descriptions:

NAICS Code:	56299
NAICS Description:	ALL OTHER WASTE MANAGEMENT SERVICES

Facility Has Received Notices of Violations:

Violations:	No Violations Found
-------------	---------------------

Evaluation Action Summary:

Evaluations:	No Evaluations Found
--------------	----------------------

C14
East
1/8-1/4
0.219 mi.
1157 ft.

JASMIN ESCUTIA
4010 E CHARTER OAK DR.
ORANGE, CA 92869

RCRA NonGen / NLR

1024781819
CAC003001788

Site 1 of 4 in cluster C

Relative:
Higher
Actual:
308 ft.

RCRA NonGen / NLR:	
Date Form Received by Agency:	2019-02-19 00:00:00.0
Handler Name:	JASMIN ESCUTIA
Handler Address:	4010 E CHARTER OAK DR.
Handler City,State,Zip:	ORANGE, CA 92869
EPA ID:	CAC003001788
Contact Name:	JOEY STOKES
Contact Address:	4010 E CHARTER OAK DR.
Contact City,State,Zip:	ORANGE, CA 92869
Contact Telephone:	714-267-7938
Contact Fax:	Not reported
Contact Email:	JOEYSTOKES@YAHOO.COM
Contact Title:	Not reported
EPA Region:	09
Land Type:	Not reported
Federal Waste Generator Description:	Not a generator, verified
Non-Notifier:	Not reported
Biennial Report Cycle:	Not reported
Accessibility:	Not reported
Active Site Indicator:	Handler Activities
State District Owner:	Not reported
State District:	Not reported
Mailing Address:	19726 SEGOVIA LANE
Mailing City,State,Zip:	YORBA LINDA, CA 92886
Owner Name:	JOEY STOKES

Map ID
 Direction
 Distance
 Elevation

MAP FINDINGS

Site

Database(s)

EDR ID Number
 EPA ID Number

JASMIN ESCUTIA (Continued)

1024781819

Owner Type:	Other
Operator Name:	JOEY STOKES
Operator Type:	Other
Short-Term Generator Activity:	No
Importer Activity:	No
Mixed Waste Generator:	No
Transporter Activity:	No
Transfer Facility Activity:	No
Recycler Activity with Storage:	No
Small Quantity On-Site Burner Exemption:	No
Smelting Melting and Refining Furnace Exemption:	No
Underground Injection Control:	No
Off-Site Waste Receipt:	No
Universal Waste Indicator:	Yes
Universal Waste Destination Facility:	Yes
Federal Universal Waste:	No
Active Site Fed-Reg Treatment Storage and Disposal Facility:	Not reported
Active Site Converter Treatment storage and Disposal Facility:	Not reported
Active Site State-Reg Treatment Storage and Disposal Facility:	Not reported
Active Site State-Reg Handler:	---
Federal Facility Indicator:	Not reported
Hazardous Secondary Material Indicator:	N
Sub-Part K Indicator:	Not reported
Commercial TSD Indicator:	No
Treatment Storage and Disposal Type:	Not reported
2018 GPRA Permit Baseline:	Not on the Baseline
2018 GPRA Renewals Baseline:	Not on the Baseline
Permit Renewals Workload Universe:	Not reported
Permit Workload Universe:	Not reported
Permit Progress Universe:	Not reported
Post-Closure Workload Universe:	Not reported
Closure Workload Universe:	Not reported
202 GPRA Corrective Action Baseline:	No
Corrective Action Workload Universe:	No
Subject to Corrective Action Universe:	No
Non-TSDs Where RCRA CA has Been Imposed Universe:	No
TSDs Potentially Subject to CA Under 3004 (u)/(v) Universe:	No
TSDs Only Subject to CA under Discretionary Auth Universe:	No
Corrective Action Priority Ranking:	No NCAPS ranking
Environmental Control Indicator:	No
Institutional Control Indicator:	No
Human Exposure Controls Indicator:	N/A
Groundwater Controls Indicator:	N/A
Operating TSD Universe:	Not reported
Full Enforcement Universe:	Not reported
Significant Non-Complier Universe:	No
Unaddressed Significant Non-Complier Universe:	No
Addressed Significant Non-Complier Universe:	No
Significant Non-Complier With a Compliance Schedule Universe:	No
Financial Assurance Required:	Not reported
Handler Date of Last Change:	2019-02-22 19:41:48.0
Recognized Trader-Importer:	No
Recognized Trader-Exporter:	No
Importer of Spent Lead Acid Batteries:	No
Exporter of Spent Lead Acid Batteries:	No
Recycler Activity Without Storage:	No
Manifest Broker:	No

Map ID
Direction
Distance
Elevation

MAP FINDINGS

Site

Database(s)

EDR ID Number
EPA ID Number

JASMIN ESCUTIA (Continued)

1024781819

Sub-Part P Indicator: No

Handler - Owner Operator:
Owner/Operator Indicator: Owner
Owner/Operator Name: JOEY STOKES
Legal Status: Other
Date Became Current: Not reported
Date Ended Current: Not reported
Owner/Operator Address: 4010 E CHARTER OAK DR.
Owner/Operator City,State,Zip: ORANGE, CA 92869
Owner/Operator Telephone: 714-267-7938
Owner/Operator Telephone Ext: Not reported
Owner/Operator Fax: Not reported
Owner/Operator Email: Not reported

Owner/Operator Indicator: Operator
Owner/Operator Name: JOEY STOKES
Legal Status: Other
Date Became Current: Not reported
Date Ended Current: Not reported
Owner/Operator Address: 4010 E CHARTER OAK DR.
Owner/Operator City,State,Zip: ORANGE, CA 92869
Owner/Operator Telephone: 714-267-7938
Owner/Operator Telephone Ext: Not reported
Owner/Operator Fax: Not reported
Owner/Operator Email: Not reported

Historic Generators:
Receive Date: 2019-02-19 00:00:00.0
Handler Name: JASMIN ESCUTIA
Federal Waste Generator Description: Not a generator, verified
State District Owner: Not reported
Large Quantity Handler of Universal Waste: No
Recognized Trader Importer: No
Recognized Trader Exporter: No
Spent Lead Acid Battery Importer: No
Spent Lead Acid Battery Exporter: No
Current Record: Yes
Non Storage Recycler Activity: Not reported
Electronic Manifest Broker: Not reported

List of NAICS Codes and Descriptions:
NAICS Code: 56299
NAICS Description: ALL OTHER WASTE MANAGEMENT SERVICES

Facility Has Received Notices of Violations:
Violations: No Violations Found

Evaluation Action Summary:
Evaluations: No Evaluations Found

MAP FINDINGS

Map ID
 Direction
 Distance
 Elevation
 Site
 Database(s)
 EDR ID Number
 EPA ID Number

Map ID	Direction	Distance	Elevation	Site	Database(s)	EDR ID Number	EPA ID Number
C15	East	1/8-1/4	0.223 mi.	JOEY STOKES-KING 4020 E CHARTER OAK DR ORANGE, CA 92869	RCRA NonGen / NLR	1024781859	CAC003001828
1180 ft.				Site 2 of 4 in cluster C			
Relative: Higher				RCRA NonGen / NLR:			
Actual: 309 ft.				Date Form Received by Agency:	2019-02-20 00:00:00.0		
				Handler Name:	JOEY STOKES-KING		
				Handler Address:	4020 E CHARTER OAK DR		
				Handler City,State,Zip:	ORANGE, CA 92869		
				EPA ID:	CAC003001828		
				Contact Name:	JOEY STOKES-KING		
				Contact Address:	4020 E CHARTER OAK DR		
				Contact City,State,Zip:	ORANGE, CA 92869		
				Contact Telephone:	714-267-7938		
				Contact Fax:	Not reported		
				Contact Email:	AMARTINO@VIKINGENVIRO.COM		
				Contact Title:	Not reported		
				EPA Region:	09		
				Land Type:	Not reported		
				Federal Waste Generator Description:	Not a generator, verified		
				Non-Notifier:	Not reported		
				Biennial Report Cycle:	Not reported		
				Accessibility:	Not reported		
				Active Site Indicator:	Handler Activities		
				State District Owner:	Not reported		
				State District:	Not reported		
				Mailing Address:	4020 E CHARTER OAK DR		
				Mailing City,State,Zip:	ORANGE, CA 92869		
				Owner Name:	JOEY STOKES-KING		
				Owner Type:	Other		
				Operator Name:	JOEY STOKES-KING		
				Operator Type:	Other		
				Short-Term Generator Activity:	No		
				Importer Activity:	No		
				Mixed Waste Generator:	No		
				Transporter Activity:	No		
				Transfer Facility Activity:	No		
				Recycler Activity with Storage:	No		
				Small Quantity On-Site Burner Exemption:	No		
				Smelting Melting and Refining Furnace Exemption:	No		
				Underground Injection Control:	No		
				Off-Site Waste Receipt:	No		
				Universal Waste Indicator:	Yes		
				Universal Waste Destination Facility:	Yes		
				Federal Universal Waste:	No		
				Active Site Fed-Reg Treatment Storage and Disposal Facility:	Not reported		
				Active Site Converter Treatment storage and Disposal Facility:	Not reported		
				Active Site State-Reg Treatment Storage and Disposal Facility:	Not reported		
				Active Site State-Reg Handler:	---		
				Federal Facility Indicator:	Not reported		
				Hazardous Secondary Material Indicator:	N		
				Sub-Part K Indicator:	Not reported		
				Commercial TSD Indicator:	No		
				Treatment Storage and Disposal Type:	Not reported		
				2018 GPRA Permit Baseline:	Not on the Baseline		
				2018 GPRA Renewals Baseline:	Not on the Baseline		
				Permit Renewals Workload Universe:	Not reported		

Map ID
 Direction
 Distance
 Elevation

MAP FINDINGS

Site

Database(s)

EDR ID Number
 EPA ID Number

JOEY STOKES-KING (Continued)

1024781859

Permit Workload Universe:	Not reported
Permit Progress Universe:	Not reported
Post-Closure Workload Universe:	Not reported
Closure Workload Universe:	Not reported
202 GPRA Corrective Action Baseline:	No
Corrective Action Workload Universe:	No
Subject to Corrective Action Universe:	No
Non-TSDFs Where RCRA CA has Been Imposed Universe:	No
TSDFs Potentially Subject to CA Under 3004 (u)/(v) Universe:	No
TSDFs Only Subject to CA under Discretionary Auth Universe:	No
Corrective Action Priority Ranking:	No NCAPS ranking
Environmental Control Indicator:	No
Institutional Control Indicator:	No
Human Exposure Controls Indicator:	N/A
Groundwater Controls Indicator:	N/A
Operating TSDF Universe:	Not reported
Full Enforcement Universe:	Not reported
Significant Non-Complier Universe:	No
Unaddressed Significant Non-Complier Universe:	No
Addressed Significant Non-Complier Universe:	No
Significant Non-Complier With a Compliance Schedule Universe:	No
Financial Assurance Required:	Not reported
Handler Date of Last Change:	2019-02-22 19:41:49.0
Recognized Trader-Importer:	No
Recognized Trader-Exporter:	No
Importer of Spent Lead Acid Batteries:	No
Exporter of Spent Lead Acid Batteries:	No
Recycler Activity Without Storage:	No
Manifest Broker:	No
Sub-Part P Indicator:	No

Handler - Owner Operator:

Owner/Operator Indicator:	Owner
Owner/Operator Name:	JOEY STOKES-KING
Legal Status:	Other
Date Became Current:	Not reported
Date Ended Current:	Not reported
Owner/Operator Address:	4020 E CHARTER OAK DR
Owner/Operator City,State,Zip:	ORANGE, CA 92869
Owner/Operator Telephone:	714-267-7938
Owner/Operator Telephone Ext:	Not reported
Owner/Operator Fax:	Not reported
Owner/Operator Email:	Not reported

Owner/Operator Indicator:	Operator
Owner/Operator Name:	JOEY STOKES-KING
Legal Status:	Other
Date Became Current:	Not reported
Date Ended Current:	Not reported
Owner/Operator Address:	4020 E CHARTER OAK DR
Owner/Operator City,State,Zip:	ORANGE, CA 92869
Owner/Operator Telephone:	714-267-7938
Owner/Operator Telephone Ext:	Not reported
Owner/Operator Fax:	Not reported
Owner/Operator Email:	Not reported

Map ID
 Direction
 Distance
 Elevation

MAP FINDINGS

Site

Database(s)

EDR ID Number
 EPA ID Number

JOEY STOKES-KING (Continued)

1024781859

Historic Generators:

Receive Date:	2019-02-20 00:00:00.0
Handler Name:	JOEY STOKES-KING
Federal Waste Generator Description:	Not a generator, verified
State District Owner:	Not reported
Large Quantity Handler of Universal Waste:	No
Recognized Trader Importer:	No
Recognized Trader Exporter:	No
Spent Lead Acid Battery Importer:	No
Spent Lead Acid Battery Exporter:	No
Current Record:	Yes
Non Storage Recycler Activity:	Not reported
Electronic Manifest Broker:	Not reported

List of NAICS Codes and Descriptions:

NAICS Code:	56299
NAICS Description:	ALL OTHER WASTE MANAGEMENT SERVICES

Facility Has Received Notices of Violations:

Violations:	No Violations Found
-------------	---------------------

Evaluation Action Summary:

Evaluations:	No Evaluations Found
--------------	----------------------

C16
East
1/8-1/4
0.223 mi.
1180 ft.

JOEY STOKES-KING
4020 E CHARTER OAK DRV
ORANGE, CA 92869

RCRA NonGen / NLR

1024772006
CAC002991919

Site 3 of 4 in cluster C

Relative:
Higher
Actual:
309 ft.

RCRA NonGen / NLR:	
Date Form Received by Agency:	2018-12-05 00:00:00.0
Handler Name:	JOEY STOKES-KING
Handler Address:	4020 E CHARTER OAK DRV
Handler City,State,Zip:	ORANGE, CA 92869
EPA ID:	CAC002991919
Contact Name:	JOEY STOKES-KING
Contact Address:	4020 E CHARTER OAK DRV
Contact City,State,Zip:	ORANGE, CA 92869
Contact Telephone:	714-267-7938
Contact Fax:	Not reported
Contact Email:	ADMIN@VIKINGENVIRO.COM
Contact Title:	Not reported
EPA Region:	09
Land Type:	Not reported
Federal Waste Generator Description:	Not a generator, verified
Non-Notifier:	Not reported
Biennial Report Cycle:	Not reported
Accessibility:	Not reported
Active Site Indicator:	Handler Activities
State District Owner:	Not reported
State District:	Not reported
Mailing Address:	4020 E CHARTER OAK DRV
Mailing City,State,Zip:	ORANGE, CA 92869
Owner Name:	JOEY STOKES-KING

Map ID
 Direction
 Distance
 Elevation

MAP FINDINGS

Site

Database(s)

EDR ID Number
 EPA ID Number

JOEY STOKES-KING (Continued)

1024772006

Owner Type:	Other
Operator Name:	JOEY STOKES-KING
Operator Type:	Other
Short-Term Generator Activity:	No
Importer Activity:	No
Mixed Waste Generator:	No
Transporter Activity:	No
Transfer Facility Activity:	No
Recycler Activity with Storage:	No
Small Quantity On-Site Burner Exemption:	No
Smelting Melting and Refining Furnace Exemption:	No
Underground Injection Control:	No
Off-Site Waste Receipt:	No
Universal Waste Indicator:	Yes
Universal Waste Destination Facility:	Yes
Federal Universal Waste:	No
Active Site Fed-Reg Treatment Storage and Disposal Facility:	Not reported
Active Site Converter Treatment storage and Disposal Facility:	Not reported
Active Site State-Reg Treatment Storage and Disposal Facility:	Not reported
Active Site State-Reg Handler:	---
Federal Facility Indicator:	Not reported
Hazardous Secondary Material Indicator:	N
Sub-Part K Indicator:	Not reported
Commercial TSD Indicator:	No
Treatment Storage and Disposal Type:	Not reported
2018 GPRA Permit Baseline:	Not on the Baseline
2018 GPRA Renewals Baseline:	Not on the Baseline
Permit Renewals Workload Universe:	Not reported
Permit Workload Universe:	Not reported
Permit Progress Universe:	Not reported
Post-Closure Workload Universe:	Not reported
Closure Workload Universe:	Not reported
202 GPRA Corrective Action Baseline:	No
Corrective Action Workload Universe:	No
Subject to Corrective Action Universe:	No
Non-TSDs Where RCRA CA has Been Imposed Universe:	No
TSDs Potentially Subject to CA Under 3004 (u)/(v) Universe:	No
TSDs Only Subject to CA under Discretionary Auth Universe:	No
Corrective Action Priority Ranking:	No NCAPS ranking
Environmental Control Indicator:	No
Institutional Control Indicator:	No
Human Exposure Controls Indicator:	N/A
Groundwater Controls Indicator:	N/A
Operating TSD Universe:	Not reported
Full Enforcement Universe:	Not reported
Significant Non-Complier Universe:	No
Unaddressed Significant Non-Complier Universe:	No
Addressed Significant Non-Complier Universe:	No
Significant Non-Complier With a Compliance Schedule Universe:	No
Financial Assurance Required:	Not reported
Handler Date of Last Change:	2018-12-20 13:52:02.0
Recognized Trader-Importer:	No
Recognized Trader-Exporter:	No
Importer of Spent Lead Acid Batteries:	No
Exporter of Spent Lead Acid Batteries:	No
Recycler Activity Without Storage:	No
Manifest Broker:	No

Map ID
Direction
Distance
Elevation

MAP FINDINGS

Site

Database(s)

EDR ID Number
EPA ID Number

JOEY STOKES-KING (Continued)

1024772006

Sub-Part P Indicator: No

Handler - Owner Operator:
Owner/Operator Indicator: Owner
Owner/Operator Name: JOEY STOKES-KING
Legal Status: Other
Date Became Current: Not reported
Date Ended Current: Not reported
Owner/Operator Address: 4020 E CHARTER OAK DRV
Owner/Operator City,State,Zip: ORANGE, CA 92869
Owner/Operator Telephone: 714-267-7938
Owner/Operator Telephone Ext: Not reported
Owner/Operator Fax: Not reported
Owner/Operator Email: Not reported

Owner/Operator Indicator: Operator
Owner/Operator Name: JOEY STOKES-KING
Legal Status: Other
Date Became Current: Not reported
Date Ended Current: Not reported
Owner/Operator Address: 4020 E CHARTER OAK DRV
Owner/Operator City,State,Zip: ORANGE, CA 92869
Owner/Operator Telephone: 714-267-7938
Owner/Operator Telephone Ext: Not reported
Owner/Operator Fax: Not reported
Owner/Operator Email: Not reported

Historic Generators:
Receive Date: 2018-12-05 00:00:00.0
Handler Name: JOEY STOKES-KING
Federal Waste Generator Description: Not a generator, verified
State District Owner: Not reported
Large Quantity Handler of Universal Waste: No
Recognized Trader Importer: No
Recognized Trader Exporter: No
Spent Lead Acid Battery Importer: No
Spent Lead Acid Battery Exporter: No
Current Record: Yes
Non Storage Recycler Activity: Not reported
Electronic Manifest Broker: Not reported

List of NAICS Codes and Descriptions:
NAICS Code: 56299
NAICS Description: ALL OTHER WASTE MANAGEMENT SERVICES

Facility Has Received Notices of Violations:
Violations: No Violations Found

Evaluation Action Summary:
Evaluations: No Evaluations Found

Map ID
 Direction
 Distance
 Elevation

MAP FINDINGS

Site

Database(s)

EDR ID Number
 EPA ID Number

17
SSE
1/8-1/4
0.236 mi.
1246 ft.

ROBERT FOYLE
3803 EUCLID AVE
ORANGE, CA 92869

RCRA NonGen / NLR

1024781543
CAC003001511

Relative:
Lower
Actual:
293 ft.

RCRA NonGen / NLR:		2019-02-18 00:00:00.0
Date Form Received by Agency:		
Handler Name:	ROBERT FOYLE	
Handler Address:		3803 EUCLID AVE
Handler City,State,Zip:		ORANGE, CA 92869
EPA ID:		CAC003001511
Contact Name:		ROBERT FOYLE
Contact Address:		3803 EUCLID AVE
Contact City,State,Zip:		ORANGE, CA 92869
Contact Telephone:		714-496-1672
Contact Fax:		Not reported
Contact Email:		KC@AQHIINC.COM
Contact Title:		Not reported
EPA Region:		09
Land Type:		Not reported
Federal Waste Generator Description:		Not a generator, verified
Non-Notifier:		Not reported
Biennial Report Cycle:		Not reported
Accessibility:		Not reported
Active Site Indicator:		Handler Activities
State District Owner:		Not reported
State District:		Not reported
Mailing Address:		3803 EUCLID AVE
Mailing City,State,Zip:		ORANGE, CA 92869
Owner Name:		ROBERT FOYLE
Owner Type:		Other
Operator Name:		ROBERT FOYLE
Operator Type:		Other
Short-Term Generator Activity:		No
Importer Activity:		No
Mixed Waste Generator:		No
Transporter Activity:		No
Transfer Facility Activity:		No
Recycler Activity with Storage:		No
Small Quantity On-Site Burner Exemption:		No
Smelting Melting and Refining Furnace Exemption:		No
Underground Injection Control:		No
Off-Site Waste Receipt:		No
Universal Waste Indicator:		Yes
Universal Waste Destination Facility:		Yes
Federal Universal Waste:		No
Active Site Fed-Reg Treatment Storage and Disposal Facility:		Not reported
Active Site Converter Treatment storage and Disposal Facility:		Not reported
Active Site State-Reg Treatment Storage and Disposal Facility:		Not reported
Active Site State-Reg Handler:		---
Federal Facility Indicator:		Not reported
Hazardous Secondary Material Indicator:		N
Sub-Part K Indicator:		Not reported
Commercial TSD Indicator:		No
Treatment Storage and Disposal Type:		Not reported
2018 GPRA Permit Baseline:		Not on the Baseline
2018 GPRA Renewals Baseline:		Not on the Baseline
Permit Renewals Workload Universe:		Not reported

Map ID
 Direction
 Distance
 Elevation

MAP FINDINGS

Site

Database(s)

EDR ID Number
 EPA ID Number

ROBERT FOYLE (Continued)

1024781543

Permit Workload Universe:	Not reported
Permit Progress Universe:	Not reported
Post-Closure Workload Universe:	Not reported
Closure Workload Universe:	Not reported
202 GPRA Corrective Action Baseline:	No
Corrective Action Workload Universe:	No
Subject to Corrective Action Universe:	No
Non-TSDFs Where RCRA CA has Been Imposed Universe:	No
TSDFs Potentially Subject to CA Under 3004 (u)/(v) Universe:	No
TSDFs Only Subject to CA under Discretionary Auth Universe:	No
Corrective Action Priority Ranking:	No NCAPS ranking
Environmental Control Indicator:	No
Institutional Control Indicator:	No
Human Exposure Controls Indicator:	N/A
Groundwater Controls Indicator:	N/A
Operating TSDF Universe:	Not reported
Full Enforcement Universe:	Not reported
Significant Non-Complier Universe:	No
Unaddressed Significant Non-Complier Universe:	No
Addressed Significant Non-Complier Universe:	No
Significant Non-Complier With a Compliance Schedule Universe:	No
Financial Assurance Required:	Not reported
Handler Date of Last Change:	2019-02-22 19:41:43.0
Recognized Trader-Importer:	No
Recognized Trader-Exporter:	No
Importer of Spent Lead Acid Batteries:	No
Exporter of Spent Lead Acid Batteries:	No
Recycler Activity Without Storage:	No
Manifest Broker:	No
Sub-Part P Indicator:	No

Handler - Owner Operator:

Owner/Operator Indicator:	Owner
Owner/Operator Name:	ROBERT FOYLE
Legal Status:	Other
Date Became Current:	Not reported
Date Ended Current:	Not reported
Owner/Operator Address:	3803 EUCLID AVE
Owner/Operator City,State,Zip:	ORANGE, CA 92869
Owner/Operator Telephone:	714-496-1672
Owner/Operator Telephone Ext:	Not reported
Owner/Operator Fax:	Not reported
Owner/Operator Email:	Not reported

Owner/Operator Indicator:	Operator
Owner/Operator Name:	ROBERT FOYLE
Legal Status:	Other
Date Became Current:	Not reported
Date Ended Current:	Not reported
Owner/Operator Address:	3803 EUCLID AVE
Owner/Operator City,State,Zip:	ORANGE, CA 92869
Owner/Operator Telephone:	714-496-1672
Owner/Operator Telephone Ext:	Not reported
Owner/Operator Fax:	Not reported
Owner/Operator Email:	Not reported

Map ID
Direction
Distance
Elevation

MAP FINDINGS

Site

Database(s)

EDR ID Number
EPA ID Number

ROBERT FOYLE (Continued)

1024781543

Historic Generators:

Receive Date: 2019-02-18 00:00:00.0
Handler Name: ROBERT FOYLE
Federal Waste Generator Description: Not a generator, verified
State District Owner: Not reported
Large Quantity Handler of Universal Waste: No
Recognized Trader Importer: No
Recognized Trader Exporter: No
Spent Lead Acid Battery Importer: No
Spent Lead Acid Battery Exporter: No
Current Record: Yes
Non Storage Recycler Activity: Not reported
Electronic Manifest Broker: Not reported

List of NAICS Codes and Descriptions:

NAICS Code: 56299
NAICS Description: ALL OTHER WASTE MANAGEMENT SERVICES

Facility Has Received Notices of Violations:

Violations: No Violations Found

Evaluation Action Summary:

Evaluations: No Evaluations Found

**D18
NW
1/8-1/4
0.239 mi.
1260 ft.**

**MICHAEL BRADBURY
3340 E COLLINS AVE APT 46
ORANGE, CA 92867**

RCRA NonGen / NLR

**1025861963
CAC003042661**

Site 1 of 5 in cluster D

**Relative:
Higher
Actual:
302 ft.**

RCRA NonGen / NLR:
Date Form Received by Agency: 2019-11-11 00:00:00.0
Handler Name: MICHAEL BRADBURY
Handler Address: 3340 E COLLINS AVE APT 46
Handler City,State,Zip: ORANGE, CA 92867-7584
EPA ID: CAC003042661
Contact Name: MICHAEL BRADBURY
Contact Address: 3340 E COLLINS AVE APT 46
Contact City,State,Zip: ORANGE, CA 92867-7584
Contact Telephone: 714-310-1747
Contact Fax: Not reported
Contact Email: NANCYRUIZ@ALLIANCE-ENVIRO.COM
Contact Title: Not reported
EPA Region: 09
Land Type: Not reported
Federal Waste Generator Description: Not a generator, verified
Non-Notifier: Not reported
Biennial Report Cycle: Not reported
Accessibility: Not reported
Active Site Indicator: Not reported
State District Owner: Not reported
State District: Not reported
Mailing Address: 3340 E COLLINS AVE APT 46
Mailing City,State,Zip: ORANGE, CA 92867-7584
Owner Name: MICHAEL BRADBURY

Map ID
 Direction
 Distance
 Elevation

MAP FINDINGS

Site

Database(s)

EDR ID Number
 EPA ID Number

MICHAEL BRADBURY (Continued)

1025861963

Owner Type:	Other
Operator Name:	MICHAEL BRADBURY
Operator Type:	Other
Short-Term Generator Activity:	No
Importer Activity:	No
Mixed Waste Generator:	No
Transporter Activity:	No
Transfer Facility Activity:	No
Recycler Activity with Storage:	No
Small Quantity On-Site Burner Exemption:	No
Smelting Melting and Refining Furnace Exemption:	No
Underground Injection Control:	No
Off-Site Waste Receipt:	No
Universal Waste Indicator:	No
Universal Waste Destination Facility:	No
Federal Universal Waste:	No
Active Site Fed-Reg Treatment Storage and Disposal Facility:	Not reported
Active Site Converter Treatment storage and Disposal Facility:	Not reported
Active Site State-Reg Treatment Storage and Disposal Facility:	Not reported
Active Site State-Reg Handler:	---
Federal Facility Indicator:	Not reported
Hazardous Secondary Material Indicator:	N
Sub-Part K Indicator:	Not reported
Commercial TSD Indicator:	No
Treatment Storage and Disposal Type:	Not reported
2018 GPRA Permit Baseline:	Not on the Baseline
2018 GPRA Renewals Baseline:	Not on the Baseline
Permit Renewals Workload Universe:	Not reported
Permit Workload Universe:	Not reported
Permit Progress Universe:	Not reported
Post-Closure Workload Universe:	Not reported
Closure Workload Universe:	Not reported
202 GPRA Corrective Action Baseline:	No
Corrective Action Workload Universe:	No
Subject to Corrective Action Universe:	No
Non-TSDs Where RCRA CA has Been Imposed Universe:	No
TSDs Potentially Subject to CA Under 3004 (u)/(v) Universe:	No
TSDs Only Subject to CA under Discretionary Auth Universe:	No
Corrective Action Priority Ranking:	No NCAPS ranking
Environmental Control Indicator:	No
Institutional Control Indicator:	No
Human Exposure Controls Indicator:	N/A
Groundwater Controls Indicator:	N/A
Operating TSD Universe:	Not reported
Full Enforcement Universe:	Not reported
Significant Non-Complier Universe:	No
Unaddressed Significant Non-Complier Universe:	No
Addressed Significant Non-Complier Universe:	No
Significant Non-Complier With a Compliance Schedule Universe:	No
Financial Assurance Required:	Not reported
Handler Date of Last Change:	2019-11-22 19:28:40.0
Recognized Trader-Importer:	No
Recognized Trader-Exporter:	No
Importer of Spent Lead Acid Batteries:	No
Exporter of Spent Lead Acid Batteries:	No
Recycler Activity Without Storage:	No
Manifest Broker:	No

Map ID
Direction
Distance
Elevation

MAP FINDINGS

Site

Database(s)

EDR ID Number
EPA ID Number

MICHAEL BRADBURY (Continued)

1025861963

Sub-Part P Indicator: No

Handler - Owner Operator:
Owner/Operator Indicator: Operator
Owner/Operator Name: MICHAEL BRADBURY
Legal Status: Other
Date Became Current: Not reported
Date Ended Current: Not reported
Owner/Operator Address: 3340 E COLLINS AVE APT 46
Owner/Operator City,State,Zip: ORANGE, CA 92867-7584
Owner/Operator Telephone: 714-310-1747
Owner/Operator Telephone Ext: Not reported
Owner/Operator Fax: Not reported
Owner/Operator Email: Not reported

Owner/Operator Indicator: Owner
Owner/Operator Name: MICHAEL BRADBURY
Legal Status: Other
Date Became Current: Not reported
Date Ended Current: Not reported
Owner/Operator Address: 3340 E COLLINS AVE APT 46
Owner/Operator City,State,Zip: ORANGE, CA 92867-7584
Owner/Operator Telephone: 714-310-1747
Owner/Operator Telephone Ext: Not reported
Owner/Operator Fax: Not reported
Owner/Operator Email: Not reported

Historic Generators:
Receive Date: 2019-11-11 00:00:00.0
Handler Name: MICHAEL BRADBURY
Federal Waste Generator Description: Not a generator, verified
State District Owner: Not reported
Large Quantity Handler of Universal Waste: No
Recognized Trader Importer: No
Recognized Trader Exporter: No
Spent Lead Acid Battery Importer: No
Spent Lead Acid Battery Exporter: No
Current Record: Yes
Non Storage Recycler Activity: Not reported
Electronic Manifest Broker: Not reported

List of NAICS Codes and Descriptions:
NAICS Code: 56299
NAICS Description: ALL OTHER WASTE MANAGEMENT SERVICES

Facility Has Received Notices of Violations:
Violations: No Violations Found

Evaluation Action Summary:
Evaluations: No Evaluations Found

Map ID
 Direction
 Distance
 Elevation

MAP FINDINGS

Site

Database(s)

EDR ID Number
 EPA ID Number

D19 **ADAM TOMBELAINE** **RCRA NonGen / NLR** **1024753763**
NW **3340 E COLLINS #61** **CAC002973577**
1/8-1/4 **ORANGE, CA 92867**
0.239 mi.
1260 ft. **Site 2 of 5 in cluster D**

Relative:
Higher
Actual:
302 ft.

RCRA NonGen / NLR:		2018-08-01 00:00:00.0
Date Form Received by Agency:		
Handler Name:	ADAM TOMBELAINE	
Handler Address:	3340 E COLLINS #61	
Handler City,State,Zip:	ORANGE, CA 92867	
EPA ID:	CAC002973577	
Contact Name:	ADAM TOMBELAINE	
Contact Address:	3340 E COLLINS #61	
Contact City,State,Zip:	ORANGE, CA 92867	
Contact Telephone:	818-585-1328	
Contact Fax:	Not reported	
Contact Email:	KC@AQHIINC.COM	
Contact Title:	Not reported	
EPA Region:	09	
Land Type:	Not reported	
Federal Waste Generator Description:	Not a generator, verified	
Non-Notifier:	Not reported	
Biennial Report Cycle:	Not reported	
Accessibility:	Not reported	
Active Site Indicator:	Handler Activities	
State District Owner:	Not reported	
State District:	Not reported	
Mailing Address:	3340 E COLLINS #61	
Mailing City,State,Zip:	ORANGE, CA 92867	
Owner Name:	ADAM TOMBELAINE	
Owner Type:	Other	
Operator Name:	ADAM TOMBELAINE	
Operator Type:	Other	
Short-Term Generator Activity:	No	
Importer Activity:	No	
Mixed Waste Generator:	No	
Transporter Activity:	No	
Transfer Facility Activity:	No	
Recycler Activity with Storage:	No	
Small Quantity On-Site Burner Exemption:	No	
Smelting Melting and Refining Furnace Exemption:	No	
Underground Injection Control:	No	
Off-Site Waste Receipt:	No	
Universal Waste Indicator:	Yes	
Universal Waste Destination Facility:	Yes	
Federal Universal Waste:	No	
Active Site Fed-Reg Treatment Storage and Disposal Facility:	Not reported	
Active Site Converter Treatment storage and Disposal Facility:	Not reported	
Active Site State-Reg Treatment Storage and Disposal Facility:	Not reported	
Active Site State-Reg Handler:	---	
Federal Facility Indicator:	Not reported	
Hazardous Secondary Material Indicator:	N	
Sub-Part K Indicator:	Not reported	
Commercial TSD Indicator:	No	
Treatment Storage and Disposal Type:	Not reported	
2018 GPRA Permit Baseline:	Not on the Baseline	
2018 GPRA Renewals Baseline:	Not on the Baseline	
Permit Renewals Workload Universe:	Not reported	

Map ID
 Direction
 Distance
 Elevation

MAP FINDINGS

Site

Database(s)

EDR ID Number
 EPA ID Number

ADAM TOMBELAINE (Continued)

1024753763

Permit Workload Universe:	Not reported
Permit Progress Universe:	Not reported
Post-Closure Workload Universe:	Not reported
Closure Workload Universe:	Not reported
202 GPRA Corrective Action Baseline:	No
Corrective Action Workload Universe:	No
Subject to Corrective Action Universe:	No
Non-TSDFs Where RCRA CA has Been Imposed Universe:	No
TSDFs Potentially Subject to CA Under 3004 (u)/(v) Universe:	No
TSDFs Only Subject to CA under Discretionary Auth Universe:	No
Corrective Action Priority Ranking:	No NCAPS ranking
Environmental Control Indicator:	No
Institutional Control Indicator:	No
Human Exposure Controls Indicator:	N/A
Groundwater Controls Indicator:	N/A
Operating TSDF Universe:	Not reported
Full Enforcement Universe:	Not reported
Significant Non-Complier Universe:	No
Unaddressed Significant Non-Complier Universe:	No
Addressed Significant Non-Complier Universe:	No
Significant Non-Complier With a Compliance Schedule Universe:	No
Financial Assurance Required:	Not reported
Handler Date of Last Change:	2018-08-31 17:13:44.0
Recognized Trader-Importer:	No
Recognized Trader-Exporter:	No
Importer of Spent Lead Acid Batteries:	No
Exporter of Spent Lead Acid Batteries:	No
Recycler Activity Without Storage:	No
Manifest Broker:	No
Sub-Part P Indicator:	No

Handler - Owner Operator:

Owner/Operator Indicator:	Operator
Owner/Operator Name:	ADAM TOMBELAINE
Legal Status:	Other
Date Became Current:	Not reported
Date Ended Current:	Not reported
Owner/Operator Address:	3340 E COLLINS #61
Owner/Operator City,State,Zip:	ORANGE, CA 92867
Owner/Operator Telephone:	818-585-1328
Owner/Operator Telephone Ext:	Not reported
Owner/Operator Fax:	Not reported
Owner/Operator Email:	Not reported

Owner/Operator Indicator:	Owner
Owner/Operator Name:	ADAM TOMBELAINE
Legal Status:	Other
Date Became Current:	Not reported
Date Ended Current:	Not reported
Owner/Operator Address:	3340 E COLLINS #61
Owner/Operator City,State,Zip:	ORANGE, CA 92867
Owner/Operator Telephone:	818-585-1328
Owner/Operator Telephone Ext:	Not reported
Owner/Operator Fax:	Not reported
Owner/Operator Email:	Not reported

Map ID
Direction
Distance
Elevation

MAP FINDINGS

Site

Database(s)

EDR ID Number
EPA ID Number

ADAM TOMBELAINE (Continued)

1024753763

Historic Generators:

Receive Date: 2018-08-01 00:00:00.0
Handler Name: ADAM TOMBELAINE
Federal Waste Generator Description: Not a generator, verified
State District Owner: Not reported
Large Quantity Handler of Universal Waste: No
Recognized Trader Importer: No
Recognized Trader Exporter: No
Spent Lead Acid Battery Importer: No
Spent Lead Acid Battery Exporter: No
Current Record: Yes
Non Storage Recycler Activity: Not reported
Electronic Manifest Broker: Not reported

List of NAICS Codes and Descriptions:

NAICS Code: 56299
NAICS Description: ALL OTHER WASTE MANAGEMENT SERVICES

Facility Has Received Notices of Violations:

Violations: No Violations Found

Evaluation Action Summary:

Evaluations: No Evaluations Found

**D20
NW
1/8-1/4
0.239 mi.
1260 ft.**

**STEVE HAMRELL
3340 EAST COLLINS AVE #9
ORANGE, CA 92867**

RCRA NonGen / NLR

**1024747391
CAC002967168**

Site 3 of 5 in cluster D

**Relative:
Higher
Actual:
302 ft.**

RCRA NonGen / NLR:
Date Form Received by Agency: 2018-06-19 00:00:00.0
Handler Name: STEVE HAMRELL
Handler Address: 3340 EAST COLLINS AVE #9
Handler City,State,Zip: ORANGE, CA 92867
EPA ID: CAC002967168
Contact Name: STEVE RODRIGUEZ
Contact Address: 3340 EAST COLLINS AVE #9
Contact City,State,Zip: ORANGE, CA 92867
Contact Telephone: 213-859-4712
Contact Fax: Not reported
Contact Email: DAISY@SUPERIORENV.COM
Contact Title: Not reported
EPA Region: 09
Land Type: Not reported
Federal Waste Generator Description: Not a generator, verified
Non-Notifier: Not reported
Biennial Report Cycle: Not reported
Accessibility: Not reported
Active Site Indicator: Handler Activities
State District Owner: Not reported
State District: Not reported
Mailing Address: 3340 EAST COLLINS AVE #9
Mailing City,State,Zip: ORANGE, CA 92867
Owner Name: STEVE RODRIGUEZ

Map ID
 Direction
 Distance
 Elevation

MAP FINDINGS

Site

Database(s)

EDR ID Number
 EPA ID Number

STEVE HAMRELL (Continued)

1024747391

Owner Type:	Other
Operator Name:	STEVE RODRIGUEZ
Operator Type:	Other
Short-Term Generator Activity:	No
Importer Activity:	No
Mixed Waste Generator:	No
Transporter Activity:	No
Transfer Facility Activity:	No
Recycler Activity with Storage:	No
Small Quantity On-Site Burner Exemption:	No
Smelting Melting and Refining Furnace Exemption:	No
Underground Injection Control:	No
Off-Site Waste Receipt:	No
Universal Waste Indicator:	Yes
Universal Waste Destination Facility:	Yes
Federal Universal Waste:	No
Active Site Fed-Reg Treatment Storage and Disposal Facility:	Not reported
Active Site Converter Treatment storage and Disposal Facility:	Not reported
Active Site State-Reg Treatment Storage and Disposal Facility:	Not reported
Active Site State-Reg Handler:	---
Federal Facility Indicator:	Not reported
Hazardous Secondary Material Indicator:	N
Sub-Part K Indicator:	Not reported
Commercial TSD Indicator:	No
Treatment Storage and Disposal Type:	Not reported
2018 GPRA Permit Baseline:	Not on the Baseline
2018 GPRA Renewals Baseline:	Not on the Baseline
Permit Renewals Workload Universe:	Not reported
Permit Workload Universe:	Not reported
Permit Progress Universe:	Not reported
Post-Closure Workload Universe:	Not reported
Closure Workload Universe:	Not reported
202 GPRA Corrective Action Baseline:	No
Corrective Action Workload Universe:	No
Subject to Corrective Action Universe:	No
Non-TSDs Where RCRA CA has Been Imposed Universe:	No
TSDs Potentially Subject to CA Under 3004 (u)/(v) Universe:	No
TSDs Only Subject to CA under Discretionary Auth Universe:	No
Corrective Action Priority Ranking:	No NCAPS ranking
Environmental Control Indicator:	No
Institutional Control Indicator:	No
Human Exposure Controls Indicator:	N/A
Groundwater Controls Indicator:	N/A
Operating TSD Universe:	Not reported
Full Enforcement Universe:	Not reported
Significant Non-Complier Universe:	No
Unaddressed Significant Non-Complier Universe:	No
Addressed Significant Non-Complier Universe:	No
Significant Non-Complier With a Compliance Schedule Universe:	No
Financial Assurance Required:	Not reported
Handler Date of Last Change:	2018-08-31 17:13:42.0
Recognized Trader-Importer:	No
Recognized Trader-Exporter:	No
Importer of Spent Lead Acid Batteries:	No
Exporter of Spent Lead Acid Batteries:	No
Recycler Activity Without Storage:	No
Manifest Broker:	No

Map ID
Direction
Distance
Elevation

MAP FINDINGS

Site

Database(s)

EDR ID Number
EPA ID Number

STEVE HAMRELL (Continued)

1024747391

Sub-Part P Indicator: No

Handler - Owner Operator:
Owner/Operator Indicator: Operator
Owner/Operator Name: STEVE RODRIGUEZ
Legal Status: Other
Date Became Current: Not reported
Date Ended Current: Not reported
Owner/Operator Address: 3340 EAST COLLINS AVE #9
Owner/Operator City,State,Zip: ORANGE, CA 92867
Owner/Operator Telephone: 213-859-4712
Owner/Operator Telephone Ext: Not reported
Owner/Operator Fax: Not reported
Owner/Operator Email: Not reported

Owner/Operator Indicator: Owner
Owner/Operator Name: STEVE RODRIGUEZ
Legal Status: Other
Date Became Current: Not reported
Date Ended Current: Not reported
Owner/Operator Address: 3340 EAST COLLINS AVE #9
Owner/Operator City,State,Zip: ORANGE, CA 92867
Owner/Operator Telephone: 213-859-4712
Owner/Operator Telephone Ext: Not reported
Owner/Operator Fax: Not reported
Owner/Operator Email: Not reported

Historic Generators:
Receive Date: 2018-06-19 00:00:00.0
Handler Name: STEVE HAMRELL
Federal Waste Generator Description: Not a generator, verified
State District Owner: Not reported
Large Quantity Handler of Universal Waste: No
Recognized Trader Importer: No
Recognized Trader Exporter: No
Spent Lead Acid Battery Importer: No
Spent Lead Acid Battery Exporter: No
Current Record: Yes
Non Storage Recycler Activity: Not reported
Electronic Manifest Broker: Not reported

List of NAICS Codes and Descriptions:
NAICS Code: 56299
NAICS Description: ALL OTHER WASTE MANAGEMENT SERVICES

Facility Has Received Notices of Violations:
Violations: No Violations Found

Evaluation Action Summary:
Evaluations: No Evaluations Found

Map ID
 Direction
 Distance
 Elevation

MAP FINDINGS

Site

Database(s)

EDR ID Number
 EPA ID Number

D21
NW
1/8-1/4
0.239 mi.
1260 ft.

CHARLENE LIEBELT
3340 EAST COLLINS AVENUE
ORANGE, CA 92867

RCRA NonGen / NLR

1025856072
CAC003036373

Site 4 of 5 in cluster D

Relative:
Higher

RCRA NonGen / NLR:

Actual:
302 ft.

Date Form Received by Agency:	2019-09-30 00:00:00.0
Handler Name:	CHARLENE LIEBELT
Handler Address:	3340 EAST COLLINS AVENUE
Handler City,State,Zip:	ORANGE, CA 92867
EPA ID:	CAC003036373
Contact Name:	CHARLENE LIEBELT
Contact Address:	3340 EAST COLLINS AVENUE
Contact City,State,Zip:	ORANGE, CA 92867
Contact Telephone:	714-323-3982
Contact Fax:	Not reported
Contact Email:	VIANCATARANGO@ALLIANCE-ENVIRO.COM
Contact Title:	Not reported
EPA Region:	09
Land Type:	Not reported
Federal Waste Generator Description:	Not a generator, verified
Non-Notifier:	Not reported
Biennial Report Cycle:	Not reported
Accessibility:	Not reported
Active Site Indicator:	Not reported
State District Owner:	Not reported
State District:	Not reported
Mailing Address:	3340 EAST COLLINS AVENUE
Mailing City,State,Zip:	ORANGE, CA 92867
Owner Name:	CHARLENE LIEBELT
Owner Type:	Other
Operator Name:	CHARLENE LIEBELT
Operator Type:	Other
Short-Term Generator Activity:	No
Importer Activity:	No
Mixed Waste Generator:	No
Transporter Activity:	No
Transfer Facility Activity:	No
Recycler Activity with Storage:	No
Small Quantity On-Site Burner Exemption:	No
Smelting Melting and Refining Furnace Exemption:	No
Underground Injection Control:	No
Off-Site Waste Receipt:	No
Universal Waste Indicator:	No
Universal Waste Destination Facility:	No
Federal Universal Waste:	No
Active Site Fed-Reg Treatment Storage and Disposal Facility:	Not reported
Active Site Converter Treatment storage and Disposal Facility:	Not reported
Active Site State-Reg Treatment Storage and Disposal Facility:	Not reported
Active Site State-Reg Handler:	---
Federal Facility Indicator:	Not reported
Hazardous Secondary Material Indicator:	N
Sub-Part K Indicator:	Not reported
Commercial TSD Indicator:	No
Treatment Storage and Disposal Type:	Not reported
2018 GPRR Permit Baseline:	Not on the Baseline
2018 GPRR Renewals Baseline:	Not on the Baseline
Permit Renewals Workload Universe:	Not reported

Map ID
 Direction
 Distance
 Elevation

MAP FINDINGS

Site

Database(s)

EDR ID Number
 EPA ID Number

CHARLENE LIEBELT (Continued)

1025856072

Permit Workload Universe:	Not reported
Permit Progress Universe:	Not reported
Post-Closure Workload Universe:	Not reported
Closure Workload Universe:	Not reported
202 GPRA Corrective Action Baseline:	No
Corrective Action Workload Universe:	No
Subject to Corrective Action Universe:	No
Non-TSDFs Where RCRA CA has Been Imposed Universe:	No
TSDFs Potentially Subject to CA Under 3004 (u)/(v) Universe:	No
TSDFs Only Subject to CA under Discretionary Auth Universe:	No
Corrective Action Priority Ranking:	No NCAPS ranking
Environmental Control Indicator:	No
Institutional Control Indicator:	No
Human Exposure Controls Indicator:	N/A
Groundwater Controls Indicator:	N/A
Operating TSDF Universe:	Not reported
Full Enforcement Universe:	Not reported
Significant Non-Complier Universe:	No
Unaddressed Significant Non-Complier Universe:	No
Addressed Significant Non-Complier Universe:	No
Significant Non-Complier With a Compliance Schedule Universe:	No
Financial Assurance Required:	Not reported
Handler Date of Last Change:	2019-10-04 16:30:47.0
Recognized Trader-Importer:	No
Recognized Trader-Exporter:	No
Importer of Spent Lead Acid Batteries:	No
Exporter of Spent Lead Acid Batteries:	No
Recycler Activity Without Storage:	No
Manifest Broker:	No
Sub-Part P Indicator:	No

Handler - Owner Operator:

Owner/Operator Indicator:	Owner
Owner/Operator Name:	CHARLENE LIEBELT
Legal Status:	Other
Date Became Current:	Not reported
Date Ended Current:	Not reported
Owner/Operator Address:	3340 EAST COLLINS AVENUE
Owner/Operator City,State,Zip:	ORANGE, CA 92867
Owner/Operator Telephone:	714-323-3982
Owner/Operator Telephone Ext:	Not reported
Owner/Operator Fax:	Not reported
Owner/Operator Email:	Not reported

Owner/Operator Indicator:	Operator
Owner/Operator Name:	CHARLENE LIEBELT
Legal Status:	Other
Date Became Current:	Not reported
Date Ended Current:	Not reported
Owner/Operator Address:	3340 EAST COLLINS AVENUE
Owner/Operator City,State,Zip:	ORANGE, CA 92867
Owner/Operator Telephone:	714-323-3982
Owner/Operator Telephone Ext:	Not reported
Owner/Operator Fax:	Not reported
Owner/Operator Email:	Not reported

Map ID
 Direction
 Distance
 Elevation

MAP FINDINGS

Site

Database(s)

EDR ID Number
 EPA ID Number

CHARLENE LIEBELT (Continued)

1025856072

Historic Generators:

Receive Date:	2019-09-30 00:00:00.0
Handler Name:	CHARLENE LIEBELT
Federal Waste Generator Description:	Not a generator, verified
State District Owner:	Not reported
Large Quantity Handler of Universal Waste:	No
Recognized Trader Importer:	No
Recognized Trader Exporter:	No
Spent Lead Acid Battery Importer:	No
Spent Lead Acid Battery Exporter:	No
Current Record:	Yes
Non Storage Recycler Activity:	Not reported
Electronic Manifest Broker:	Not reported

List of NAICS Codes and Descriptions:

NAICS Code:	56299
NAICS Description:	ALL OTHER WASTE MANAGEMENT SERVICES

Facility Has Received Notices of Violations:

Violations:	No Violations Found
-------------	---------------------

Evaluation Action Summary:

Evaluations:	No Evaluations Found
--------------	----------------------

**D22
 NW
 1/8-1/4
 0.239 mi.
 1260 ft.**

**MIKE BRADBURY
 3340 E COLLINS AVE
 ORANGE, CA 92867**

RCRA NonGen / NLR

**1026168781
 CAC003068826**

Site 5 of 5 in cluster D

**Relative:
 Higher
 Actual:
 302 ft.**

RCRA NonGen / NLR:	
Date Form Received by Agency:	2020-05-29 00:00:00.0
Handler Name:	MIKE BRADBURY
Handler Address:	3340 E COLLINS AVE
Handler City,State,Zip:	ORANGE, CA 92867
EPA ID:	CAC003068826
Contact Name:	MIKE BRADBURY
Contact Address:	3340 E COLLINS AVE
Contact City,State,Zip:	ORANGE, CA 92867
Contact Telephone:	714-373-5575
Contact Fax:	Not reported
Contact Email:	KARLA@SUPERIORENV.COM
Contact Title:	Not reported
EPA Region:	09
Land Type:	Not reported
Federal Waste Generator Description:	Not a generator, verified
Non-Notifier:	Not reported
Biennial Report Cycle:	Not reported
Accessibility:	Not reported
Active Site Indicator:	Not reported
State District Owner:	Not reported
State District:	Not reported
Mailing Address:	3340 E COLLINS AVE
Mailing City,State,Zip:	ORANGE, CA 92867
Owner Name:	MIKE BRADBURY

Map ID
 Direction
 Distance
 Elevation

MAP FINDINGS

Site

Database(s)

EDR ID Number
 EPA ID Number

MIKE BRADBURY (Continued)

1026168781

Owner Type:	Other
Operator Name:	MIKE BRADBURY
Operator Type:	Other
Short-Term Generator Activity:	No
Importer Activity:	No
Mixed Waste Generator:	No
Transporter Activity:	No
Transfer Facility Activity:	No
Recycler Activity with Storage:	No
Small Quantity On-Site Burner Exemption:	No
Smelting Melting and Refining Furnace Exemption:	No
Underground Injection Control:	No
Off-Site Waste Receipt:	No
Universal Waste Indicator:	No
Universal Waste Destination Facility:	No
Federal Universal Waste:	No
Active Site Fed-Reg Treatment Storage and Disposal Facility:	Not reported
Active Site Converter Treatment storage and Disposal Facility:	Not reported
Active Site State-Reg Treatment Storage and Disposal Facility:	Not reported
Active Site State-Reg Handler:	---
Federal Facility Indicator:	Not reported
Hazardous Secondary Material Indicator:	N
Sub-Part K Indicator:	Not reported
Commercial TSD Indicator:	No
Treatment Storage and Disposal Type:	Not reported
2018 GPRA Permit Baseline:	Not on the Baseline
2018 GPRA Renewals Baseline:	Not on the Baseline
Permit Renewals Workload Universe:	Not reported
Permit Workload Universe:	Not reported
Permit Progress Universe:	Not reported
Post-Closure Workload Universe:	Not reported
Closure Workload Universe:	Not reported
202 GPRA Corrective Action Baseline:	No
Corrective Action Workload Universe:	No
Subject to Corrective Action Universe:	No
Non-TSDs Where RCRA CA has Been Imposed Universe:	No
TSDs Potentially Subject to CA Under 3004 (u)/(v) Universe:	No
TSDs Only Subject to CA under Discretionary Auth Universe:	No
Corrective Action Priority Ranking:	No NCAPS ranking
Environmental Control Indicator:	No
Institutional Control Indicator:	No
Human Exposure Controls Indicator:	N/A
Groundwater Controls Indicator:	N/A
Operating TSD Universe:	Not reported
Full Enforcement Universe:	Not reported
Significant Non-Complier Universe:	No
Unaddressed Significant Non-Complier Universe:	No
Addressed Significant Non-Complier Universe:	No
Significant Non-Complier With a Compliance Schedule Universe:	No
Financial Assurance Required:	Not reported
Handler Date of Last Change:	2020-06-08 20:36:38.0
Recognized Trader-Importer:	No
Recognized Trader-Exporter:	No
Importer of Spent Lead Acid Batteries:	No
Exporter of Spent Lead Acid Batteries:	No
Recycler Activity Without Storage:	No
Manifest Broker:	No

Map ID
Direction
Distance
Elevation

MAP FINDINGS

Site

Database(s)

EDR ID Number
EPA ID Number

MIKE BRADBURY (Continued)

1026168781

Sub-Part P Indicator: No

Handler - Owner Operator:
Owner/Operator Indicator: Owner
Owner/Operator Name: MIKE BRADBURY
Legal Status: Other
Date Became Current: Not reported
Date Ended Current: Not reported
Owner/Operator Address: 3340 E COLLINS AVE
Owner/Operator City,State,Zip: ORANGE, CA 92867
Owner/Operator Telephone: 714-373-5575
Owner/Operator Telephone Ext: Not reported
Owner/Operator Fax: Not reported
Owner/Operator Email: Not reported

Owner/Operator Indicator: Operator
Owner/Operator Name: MIKE BRADBURY
Legal Status: Other
Date Became Current: Not reported
Date Ended Current: Not reported
Owner/Operator Address: 3340 E COLLINS AVE
Owner/Operator City,State,Zip: ORANGE, CA 92867
Owner/Operator Telephone: 714-373-5575
Owner/Operator Telephone Ext: Not reported
Owner/Operator Fax: Not reported
Owner/Operator Email: Not reported

Historic Generators:
Receive Date: 2020-05-29 00:00:00.0
Handler Name: MIKE BRADBURY
Federal Waste Generator Description: Not a generator, verified
State District Owner: Not reported
Large Quantity Handler of Universal Waste: No
Recognized Trader Importer: No
Recognized Trader Exporter: No
Spent Lead Acid Battery Importer: No
Spent Lead Acid Battery Exporter: No
Current Record: Yes
Non Storage Recycler Activity: Not reported
Electronic Manifest Broker: Not reported

List of NAICS Codes and Descriptions:
NAICS Code: 56299
NAICS Description: ALL OTHER WASTE MANAGEMENT SERVICES

Facility Has Received Notices of Violations:
Violations: No Violations Found

Evaluation Action Summary:
Evaluations: No Evaluations Found

Map ID
 Direction
 Distance
 Elevation

MAP FINDINGS

Site

Database(s)

EDR ID Number
 EPA ID Number

RICHARD ROHR (Continued)

1024753966

Permit Workload Universe:	Not reported
Permit Progress Universe:	Not reported
Post-Closure Workload Universe:	Not reported
Closure Workload Universe:	Not reported
202 GPRA Corrective Action Baseline:	No
Corrective Action Workload Universe:	No
Subject to Corrective Action Universe:	No
Non-TSDFs Where RCRA CA has Been Imposed Universe:	No
TSDFs Potentially Subject to CA Under 3004 (u)/(v) Universe:	No
TSDFs Only Subject to CA under Discretionary Auth Universe:	No
Corrective Action Priority Ranking:	No NCAPS ranking
Environmental Control Indicator:	No
Institutional Control Indicator:	No
Human Exposure Controls Indicator:	N/A
Groundwater Controls Indicator:	N/A
Operating TSDF Universe:	Not reported
Full Enforcement Universe:	Not reported
Significant Non-Complier Universe:	No
Unaddressed Significant Non-Complier Universe:	No
Addressed Significant Non-Complier Universe:	No
Significant Non-Complier With a Compliance Schedule Universe:	No
Financial Assurance Required:	Not reported
Handler Date of Last Change:	2018-08-31 17:13:54.0
Recognized Trader-Importer:	No
Recognized Trader-Exporter:	No
Importer of Spent Lead Acid Batteries:	No
Exporter of Spent Lead Acid Batteries:	No
Recycler Activity Without Storage:	No
Manifest Broker:	No
Sub-Part P Indicator:	No

Handler - Owner Operator:

Owner/Operator Indicator:	Owner
Owner/Operator Name:	RICHARD ROHR
Legal Status:	Other
Date Became Current:	Not reported
Date Ended Current:	Not reported
Owner/Operator Address:	4031 E CHARTER OAK DR
Owner/Operator City,State,Zip:	ORANGE, CA 92869
Owner/Operator Telephone:	657-600-5266
Owner/Operator Telephone Ext:	Not reported
Owner/Operator Fax:	Not reported
Owner/Operator Email:	Not reported

Owner/Operator Indicator:	Operator
Owner/Operator Name:	RICHARD ROHR
Legal Status:	Other
Date Became Current:	Not reported
Date Ended Current:	Not reported
Owner/Operator Address:	4031 E CHARTER OAK DR
Owner/Operator City,State,Zip:	ORANGE, CA 92869
Owner/Operator Telephone:	657-600-5266
Owner/Operator Telephone Ext:	Not reported
Owner/Operator Fax:	Not reported
Owner/Operator Email:	Not reported

Map ID
 Direction
 Distance
 Elevation

MAP FINDINGS

Site

Database(s)

EDR ID Number
 EPA ID Number

RICHARD ROHR (Continued)

1024753966

Historic Generators:

Receive Date:	2018-08-02 00:00:00.0
Handler Name:	RICHARD ROHR
Federal Waste Generator Description:	Not a generator, verified
State District Owner:	Not reported
Large Quantity Handler of Universal Waste:	No
Recognized Trader Importer:	No
Recognized Trader Exporter:	No
Spent Lead Acid Battery Importer:	No
Spent Lead Acid Battery Exporter:	No
Current Record:	Yes
Non Storage Recycler Activity:	Not reported
Electronic Manifest Broker:	Not reported

List of NAICS Codes and Descriptions:

NAICS Code:	56299
NAICS Description:	ALL OTHER WASTE MANAGEMENT SERVICES

Facility Has Received Notices of Violations:

Violations:	No Violations Found
-------------	---------------------

Evaluation Action Summary:

Evaluations:	No Evaluations Found
--------------	----------------------

E24
SW
 1/4-1/2
 0.305 mi.
 1608 ft.

CAL MAT FACILITY
454 PROSPECT
ORANGE, CA 92608
 Site 1 of 4 in cluster E

LUST **S102426039**
Cortese **N/A**
CERS

Relative:
Lower
Actual:
285 ft.

LUST REG 8:	
Name:	CAL MAT FACILITY
Address:	454 PROSPECT
City:	ORANGE
Region:	8
County:	Orange
Regional Board:	Santa Ana Region
Facility Status:	Case Closed
Case Number:	083000928T
Local Case Num:	85UT003
Case Type:	Soil only
Substance:	12034,12035
Qty Leaked:	0
Abate Method:	Not reported
Cross Street:	Not reported
Enf Type:	Not reported
Funding:	Not reported
How Discovered:	Tank Closure
How Stopped:	Close Tank
Leak Cause:	Unknown
Leak Source:	Unknown
Global ID:	T0605900740
How Stopped Date:	9/9/9999
Enter Date:	Not reported
Date Confirmation of Leak Began:	Not reported

Map ID
Direction
Distance
Elevation

MAP FINDINGS

Site

Database(s)

EDR ID Number
EPA ID Number

CAL MAT FACILITY (Continued)

S102426039

Date Preliminary Assessment Began:	Not reported
Discover Date:	1/8/1985
Enforcement Date:	Not reported
Close Date:	2/15/1990
Date Prelim Assessment Workplan Submitted:	Not reported
Date Pollution Characterization Began:	Not reported
Date Remediation Plan Submitted:	Not reported
Date Remedial Action Underway:	Not reported
Date Post Remedial Action Monitoring:	Not reported
Enter Date:	Not reported
GW Qualifies:	Not reported
Soil Qualifies:	Not reported
Operator:	Not reported
Facility Contact:	Not reported
Interim:	Not reported
Oversite Program:	LUST
Latitude:	33.781182
Longitude:	-117.8184895
MTBE Date:	Not reported
Max MTBE GW:	Not reported
MTBE Concentration:	0
Max MTBE Soil:	Not reported
MTBE Fuel:	0
MTBE Tested:	Not Required to be Tested.
MTBE Class:	*
Staff:	PAH
Staff Initials:	KC
Lead Agency:	Local Agency
Local Agency:	30000L
Hydr Basin #:	Not reported
Beneficial:	MUN
Priority:	Not reported
Cleanup Fund Id:	Not reported
Work Suspended:	Not reported
Summary:	Not reported

CORTESE:

Name:	CAL MAT FACILITY
Address:	454 PROSPECT
City,State,Zip:	ORANGE, CA 92608
Region:	CORTESE
Envirostor Id:	Not reported
Global ID:	T0605900740
Site/Facility Type:	LUST CLEANUP SITE
Cleanup Status:	COMPLETED - CASE CLOSED
Status Date:	Not reported
Site Code:	Not reported
Latitude:	Not reported
Longitude:	Not reported
Owner:	Not reported
Enf Type:	Not reported
Swat R:	Not reported
Flag:	active
Order No:	Not reported
Waste Discharge System No:	Not reported
Effective Date:	Not reported
Region 2:	Not reported

Map ID
Direction
Distance
Elevation

MAP FINDINGS

Site

Database(s)

EDR ID Number
EPA ID Number

CAL MAT FACILITY (Continued)

S102426039

WID Id: Not reported
Solid Waste Id No: Not reported
Waste Management Uit Name: Not reported
File Name: Active Open

CERS:

Name: CAL MAT FACILITY
Address: 454 PROSPECT
City,State,Zip: ORANGE, CA 92608
Site ID: 209402
CERS ID: T0605900740
CERS Description: Leaking Underground Storage Tank Cleanup Site

Affiliation:

Affiliation Type Desc: Local Agency Caseworker
Entity Name: SHYAMALA RAJAGOPAL - ORANGE COUNTY LOP
Entity Title: Not reported
Affiliation Address: 1241 E. DYER ROAD SUITE 120
Affiliation City: SANTA ANA
Affiliation State: CA
Affiliation Country: Not reported
Affiliation Zip: Not reported
Affiliation Phone: 7144336262

Affiliation Type Desc: Regional Board Caseworker
Entity Name: PATRICIA HANNON - SANTA ANA RWQCB (REGION 8)
Entity Title: Not reported
Affiliation Address: 3737 MAIN STREET, SUITE 500
Affiliation City: RIVERSIDE
Affiliation State: CA
Affiliation Country: Not reported
Affiliation Zip: Not reported
Affiliation Phone: Not reported

E25
SW
1/4-1/2
0.309 mi.
1631 ft.

CAL-MAT COMPANY
454 PROSPECT
ORANGE, CA 92669
Site 2 of 4 in cluster E

HIST CORTESE **S102426082**
N/A

Relative:
Lower
Actual:
284 ft.

HIST CORTESE:
edr_fname: CAL-MAT COMPANY
edr_fadd1: 454 PROSPECT
City,State,Zip: ORANGE, CA 92669
Region: CORTESE
Facility County Code: 30
Reg By: LTNKA
Reg Id: 083000928T

Map ID
Direction
Distance
Elevation

MAP FINDINGS

Site

Database(s)
EDR ID Number
EPA ID Number

E26 **CAL MAT FACILITY**
SW **454 PROSPECT**
1/4-1/2 **ORANGE, CA 92608**
0.309 mi.
1634 ft. **Site 3 of 4 in cluster E**

LUST **S105939342**
EMI **N/A**

Relative:
Lower
Actual:
285 ft.

LUST:
Name: CAL MAT FACILITY
Address: 454 PROSPECT
City,State,Zip: ORANGE, CA 92608
Lead Agency: ORANGE COUNTY LOP
Case Type: LUST Cleanup Site
Geo Track: http://geotracker.waterboards.ca.gov/profile_report.asp?global_id=T0605900740
Global Id: T0605900740
Latitude: 33.7944462
Longitude: -117.8183766
Status: Completed - Case Closed
Status Date: 02/15/1990
Case Worker: SR
RB Case Number: 083000928T
Local Agency: ORANGE COUNTY LOP
File Location: Local Agency
Local Case Number: 85UT003
Potential Media Affect: Soil
Potential Contaminants of Concern: Diesel, Waste Oil / Motor / Hydraulic / Lubricating
Site History: Not reported

LUST:
Global Id: T0605900740
Contact Type: Regional Board Caseworker
Contact Name: PATRICIA HANNON
Organization Name: SANTA ANA RWQCB (REGION 8)
Address: 3737 MAIN STREET, SUITE 500
City: RIVERSIDE
Email: patricia.hannon@waterboards.ca.gov
Phone Number: Not reported

Global Id: T0605900740
Contact Type: Local Agency Caseworker
Contact Name: SHYAMALA RAJAGOPAL
Organization Name: ORANGE COUNTY LOP
Address: 1241 E. DYER ROAD SUITE 120
City: SANTA ANA
Email: srajagopal@ochca.com
Phone Number: 7144336262

LUST:
Global Id: T0605900740
Action Type: ENFORCEMENT
Date: 02/15/1990
Action: Closure/No Further Action Letter

Global Id: T0605900740
Action Type: Other
Date: 01/08/1985
Action: Leak Discovery

Global Id: T0605900740
Action Type: Other

Map ID
Direction
Distance
Elevation

MAP FINDINGS

Site

Database(s)

EDR ID Number
EPA ID Number

CAL MAT FACILITY (Continued)

S105939342

Date: 01/08/1985
Action: Leak Reported

LUST:

Global Id: T0605900740
Status: Open - Case Begin Date
Status Date: 01/08/1985

Global Id: T0605900740
Status: Completed - Case Closed
Status Date: 02/15/1990

EMI:

Name: ROBERTSON'S READY MIX
Address: 454 NORTH PROSPECT AVE
City,State,Zip: ORANGE, CA 92669
Year: 1997
County Code: 30
Air Basin: SC
Facility ID: 108804
Air District Name: SC
SIC Code: 2951
Air District Name: SOUTH COAST AQMD
Community Health Air Pollution Info System: Not reported
Consolidated Emission Reporting Rule: Not reported
Total Organic Hydrocarbon Gases Tons/Yr: 0
Reactive Organic Gases Tons/Yr: 0
Carbon Monoxide Emissions Tons/Yr: 1
NOX - Oxides of Nitrogen Tons/Yr: 2
SOX - Oxides of Sulphur Tons/Yr: 0
Particulate Matter Tons/Yr: 0
Part. Matter 10 Micrometers and Smlr Tons/Yr:0

Name: ROBERTSON'S READY MIX
Address: 454 NORTH PROSPECT AVE
City,State,Zip: ORANGE, CA 92669
Year: 1998
County Code: 30
Air Basin: SC
Facility ID: 108804
Air District Name: SC
SIC Code: 2951
Air District Name: SOUTH COAST AQMD
Community Health Air Pollution Info System: Not reported
Consolidated Emission Reporting Rule: Not reported
Total Organic Hydrocarbon Gases Tons/Yr: 0
Reactive Organic Gases Tons/Yr: 0
Carbon Monoxide Emissions Tons/Yr: 1
NOX - Oxides of Nitrogen Tons/Yr: 2
SOX - Oxides of Sulphur Tons/Yr: 0
Particulate Matter Tons/Yr: 0
Part. Matter 10 Micrometers and Smlr Tons/Yr:0

Name: ROBERTSON'S READY MIX
Address: 454 NORTH PROSPECT AVE

Map ID
Direction
Distance
Elevation

MAP FINDINGS

Site

Database(s)

EDR ID Number
EPA ID Number

CAL MAT FACILITY (Continued)

S105939342

City,State,Zip: ORANGE, CA 92669
Year: 1999
County Code: 30
Air Basin: SC
Facility ID: 108804
Air District Name: SC
SIC Code: 2951
Air District Name: SOUTH COAST AQMD
Community Health Air Pollution Info System: Not reported
Consolidated Emission Reporting Rule: Not reported
Total Organic Hydrocarbon Gases Tons/Yr: 0
Reactive Organic Gases Tons/Yr: 0
Carbon Monoxide Emissions Tons/Yr: 1
NOX - Oxides of Nitrogen Tons/Yr: 2
SOX - Oxides of Sulphur Tons/Yr: 0
Particulate Matter Tons/Yr: 0
Part. Matter 10 Micrometers and Smllr Tons/Yr:0

Name: ROBERTSON'S READY MIX
Address: 454 NORTH PROSPECT AVE
City,State,Zip: ORANGE, CA 92669
Year: 2000
County Code: 30
Air Basin: SC
Facility ID: 108804
Air District Name: SC
SIC Code: 2951
Air District Name: SOUTH COAST AQMD
Community Health Air Pollution Info System: Not reported
Consolidated Emission Reporting Rule: Not reported
Total Organic Hydrocarbon Gases Tons/Yr: 0
Reactive Organic Gases Tons/Yr: 0
Carbon Monoxide Emissions Tons/Yr: 1
NOX - Oxides of Nitrogen Tons/Yr: 2
SOX - Oxides of Sulphur Tons/Yr: 0
Particulate Matter Tons/Yr: 0
Part. Matter 10 Micrometers and Smllr Tons/Yr:0

Name: ROBERTSON'S READY MIX
Address: 454 NORTH PROSPECT AVE
City,State,Zip: ORANGE, CA 92669
Year: 2001
County Code: 30
Air Basin: SC
Facility ID: 108804
Air District Name: SC
SIC Code: 2951
Air District Name: SOUTH COAST AQMD
Community Health Air Pollution Info System: Not reported
Consolidated Emission Reporting Rule: Not reported
Total Organic Hydrocarbon Gases Tons/Yr: 0
Reactive Organic Gases Tons/Yr: 0
Carbon Monoxide Emissions Tons/Yr: 1
NOX - Oxides of Nitrogen Tons/Yr: 2
SOX - Oxides of Sulphur Tons/Yr: 0
Particulate Matter Tons/Yr: 0
Part. Matter 10 Micrometers and Smllr Tons/Yr:0

Map ID
Direction
Distance
Elevation

MAP FINDINGS

Site

Database(s)

EDR ID Number
EPA ID Number

E27
SW
1/4-1/2
0.309 mi.
1634 ft.

OWL ROCK PRODUCTS CO
454 N PROSPECT AVE
ORANGE, CA 92669

Site 4 of 4 in cluster E

LUST **S105938932**
EMI **N/A**
CERS

Relative:
Lower

ORANGE CO. LUST:

Actual:
285 ft.

Name: CAL MAT FACILITY
Address: 454 N PROSPECT AVE
City,State,Zip: ORANGE, CA 92608
Region: ORANGE
Facility Id: 85UT003
Released Substance: Diesel fuel oil and additives, Nos.1-D, 2-D, 2-4; Waste oil/Used oil
Date Closed: 02/15/1990
Record ID: RO0001268

EMI:

Name: OWL ROCK PRODUCTS CO
Address: 454 N PROSPECT AV
City,State,Zip: ORANGE, CA 92669
Year: 1990
County Code: 30
Air Basin: SC
Facility ID: 56965
Air District Name: SC
SIC Code: 2951
Air District Name: SOUTH COAST AQMD
Community Health Air Pollution Info System: Not reported
Consolidated Emission Reporting Rule: Not reported
Total Organic Hydrocarbon Gases Tons/Yr: 0
Reactive Organic Gases Tons/Yr: 0
Carbon Monoxide Emissions Tons/Yr: 1
NOX - Oxides of Nitrogen Tons/Yr: 2
SOX - Oxides of Sulphur Tons/Yr: 1
Particulate Matter Tons/Yr: 1
Part. Matter 10 Micrometers and Smlr Tons/Yr:0

Name: OWL ROCK PRODUCTS CO
Address: 454 N PROSPECT AV
City,State,Zip: ORANGE, CA 92669
Year: 1995
County Code: 30
Air Basin: SC
Facility ID: 56965
Air District Name: SC
SIC Code: 2951
Air District Name: SOUTH COAST AQMD
Community Health Air Pollution Info System: Not reported
Consolidated Emission Reporting Rule: Not reported
Total Organic Hydrocarbon Gases Tons/Yr: 0
Reactive Organic Gases Tons/Yr: 0
Carbon Monoxide Emissions Tons/Yr: 0
NOX - Oxides of Nitrogen Tons/Yr: 1
SOX - Oxides of Sulphur Tons/Yr: 0
Particulate Matter Tons/Yr: 0
Part. Matter 10 Micrometers and Smlr Tons/Yr:0

Name: OWL ROCK PRODUCTS CO
Address: 454 N PROSPECT AVE

Map ID
 Direction
 Distance
 Elevation

MAP FINDINGS

Site

Database(s)

EDR ID Number
 EPA ID Number

OWL ROCK PRODUCTS CO (Continued)

S105938932

City,State,Zip: ORANGE, CA 92669
 Year: 1996
 County Code: 30
 Air Basin: SC
 Facility ID: 56965
 Air District Name: SC
 SIC Code: 2951
 Air District Name: SOUTH COAST AQMD
 Community Health Air Pollution Info System: Not reported
 Consolidated Emission Reporting Rule: Not reported
 Total Organic Hydrocarbon Gases Tons/Yr: 0
 Reactive Organic Gases Tons/Yr: 0
 Carbon Monoxide Emissions Tons/Yr: 1
 NOX - Oxides of Nitrogen Tons/Yr: 2
 SOX - Oxides of Sulphur Tons/Yr: 0
 Particulate Matter Tons/Yr: 1
 Part. Matter 10 Micrometers and Smllr Tons/Yr:0

CERS:

Name: OWL ROCK PRODUCTS (ORNG ASPHALT)
 Address: 454 NORTH PROSPECT AVENUE
 City,State,Zip: ORANGE, CA 92869
 Site ID: 484907
 CERS ID: 110013828037
 CERS Description: US EPA Air Emission Inventory System (EIS)

F28
SSW
1/4-1/2
0.402 mi.
2125 ft.

GRIJALVA EXTENSION
368 N. PROSPECT AVENUE
ORANGE, CA 92869
Site 1 of 2 in cluster F

US BROWNFIELDS 1016345934
FINDS N/A

Relative:
Lower
Actual:
279 ft.

US BROWNFIELDS:
 Name: GRIJALVA EXTENSION
 Address: 368 N. PROSPECT AVENUE
 City,State,Zip: ORANGE, CA 92869
 Recipient Name: Orange, City of
 Grant Type: Assessment
 Property Number: -
 Parcel size: 27
 Latitude: 33.7924
 Longitude: -117.819
 HCM Label: -
 Map Scale: -
 Point of Reference: -
 Highlights: -
 Datum: -
 Acres Property ID: 12260
 IC Data Access: -
 Start Date: -
 Redev Completion Date: -
 Completed Date: -
 Acres Cleaned Up: -
 Cleanup Funding: -
 Cleanup Funding Source: -
 Assessment Funding: 136664.44
 Assessment Funding Source: -

Map ID
Direction
Distance
Elevation

MAP FINDINGS

Site

Database(s)

EDR ID Number
EPA ID Number

GRIJALVA EXTENSION (Continued)

1016345934

Redevelopment Funding: 3974000
Redev. Funding Source: Cal Parks
Redev. Funding Entity Name: State/Tribal Funding (non-section 128(a))
Redevelopment Start Date: 07/01/2006
Assessment Funding Entity: US EPA - Brownfields Assessment Cooperative Agreement
Cleanup Funding Entity: -
Grant Type: -
Accomplishment Type: Phase II Environmental Assessment
Accomplishment Count: N
Cooperative Agreement Number: 98997601
Start Date: 07/13/2005
Ownership Entity: Government
Completion Date: 07/13/2005
Current Owner: City of Orange
Did Owner Change: N
Cleanup Required: Y
Video Available: -
Photo Available: Y
Institutional Controls Required: -
IC Category Proprietary Controls: -
IC Cat. Info. Devices: -
IC Cat. Gov. Controls: -
IC Cat. Enforcement Permit Tools: -
IC in place date: -
IC in place: U
State/tribal program date: -
State/tribal program ID: -
State/tribal NFA date: -
Air cleaned: -
Asbestos found: -
Asbestos cleaned: -
Controlled substance found: -
Controlled substance cleaned: -
Drinking water affected: -
Drinking water cleaned: -
Groundwater affected: -
Groundwater cleaned: -
Lead contaminant found: -
Lead cleaned up: -
No media affected: Not reported
Unknown media affected: -
Other cleaned up: -
Other metals found: -
Other metals cleaned: -
Other contaminants found: -
Other contaminants found description: -
PAHs found: -
PAHs cleaned up: -
PCBs found: -
PCBs cleaned up: -
Petro products found: -
Petro products cleaned: -
Sediments found: -
Sediments cleaned: -
Soil affected: -
Soil cleaned up: -
Surface water cleaned: -

Map ID
 Direction
 Distance
 Elevation

MAP FINDINGS

Site

Database(s)

EDR ID Number
 EPA ID Number

GRIJALVA EXTENSION (Continued)

1016345934

VOCs found:	-
VOCs cleaned:	-
Cleanup other description:	-
Num. of cleanup and re-dev. jobs:	-
Past use greenspace acreage:	-
Past use residential acreage:	-
Surface Water:	-
Past use commercial acreage:	-
Past use industrial acreage:	-
Future use greenspace acreage:	-
Future use residential acreage:	-
Future use commercial acreage:	-
Future use industrial acreage:	-
Superfund Fed. landowner flag:	-
Arsenic cleaned up:	-
Cadmium cleaned up:	-
Chromium cleaned up:	-
Copper cleaned up:	-
Iron cleaned up:	-
mercury cleaned up:	-
Nickel Cleaned Up:	-
No clean up:	-
Pesticides cleaned up:	-
Selenium cleaned up:	-
SVOCs cleaned up:	-
Unknown clean up:	-
Arsenic contaminant found:	-
Cadmium contaminant found:	-
Chromium contaminant found:	-
Copper contaminant found:	-
Iron contaminant found:	-
Mercury contaminant found:	-
Nickel contaminant found:	-
No contaminant found:	-
Pesticides contaminant found:	-
Selenium contaminant found:	-
SVOCs contaminant found:	-
Unknown contaminant found:	-
Future Use: Multistory	-
Media affected Bluiding Material:	-
Media affected indoor air:	-
Building material media cleaned up:	-
Indoor air media cleaned up:	-
Unknown media cleaned up:	-
Past Use: Multistory	Not reported
Property Description:	Previously owned by Union Pacific Railroad and was formerly an orange grove, landfill, surface mine, and materials processing plant
Below Poverty Number:	541
Below Poverty Percent:	10.38
Meidan Income:	5976
Meidan Income Number:	2167
Meidan Income Percent:	41.58
Vacant Housing Number:	134
Vacant Housing Percent:	6.66
Unemployed Number:	309
Unemployed Percent:	5.93

Map ID
Direction
Distance
Elevation

MAP FINDINGS

Site

Database(s)

EDR ID Number
EPA ID Number

GRIJALVA EXTENSION (Continued)

1016345934

Name:	GRIJALVA EXTENSION
Address:	368 N. PROSPECT AVENUE
City,State,Zip:	ORANGE, CA 92869
Recipient Name:	Orange, City of
Grant Type:	Assessment
Property Number:	-
Parcel size:	27
Latitude:	33.7924
Longitude:	-117.819
HCM Label:	-
Map Scale:	-
Point of Reference:	-
Highlights:	-
Datum:	-
Acres Property ID:	12260
IC Data Access:	-
Start Date:	-
Redev Completion Date:	-
Completed Date:	-
Acres Cleaned Up:	-
Cleanup Funding:	-
Cleanup Funding Source:	-
Assessment Funding:	136664.44
Assessment Funding Source:	-
Redevelopment Funding:	70000
Redev. Funding Source:	CDBG
Redev. Funding Entity Name:	Other Federal Funding
Redevelopment Start Date:	07/01/2006
Assessment Funding Entity:	US EPA - Brownfields Assessment Cooperative Agreement
Cleanup Funding Entity:	-
Grant Type:	-
Accomplishment Type:	Phase II Environmental Assessment
Accomplishment Count:	N
Cooperative Agreement Number:	98997601
Start Date:	07/13/2005
Ownership Entity:	Government
Completion Date:	07/13/2005
Current Owner:	City of Orange
Did Owner Change:	N
Cleanup Required:	Y
Video Available:	-
Photo Available:	Y
Institutional Controls Required:	-
IC Category Proprietary Controls:	-
IC Cat. Info. Devices:	-
IC Cat. Gov. Controls:	-
IC Cat. Enforcement Permit Tools:	-
IC in place date:	-
IC in place:	U
State/tribal program date:	-
State/tribal program ID:	-
State/tribal NFA date:	-
Air cleaned:	-
Asbestos found:	-
Asbestos cleaned:	-
Controlled substance found:	-
Controlled substance cleaned:	-

Map ID
Direction
Distance
Elevation

MAP FINDINGS

Site

Database(s)

EDR ID Number
EPA ID Number

GRIJALVA EXTENSION (Continued)

1016345934

Drinking water affected:	-
Drinking water cleaned:	-
Groundwater affected:	-
Groundwater cleaned:	-
Lead contaminant found:	-
Lead cleaned up:	-
No media affected:	Not reported
Unknown media affected:	-
Other cleaned up:	-
Other metals found:	-
Other metals cleaned:	-
Other contaminants found:	-
Other contams found description:	-
PAHs found:	-
PAHs cleaned up:	-
PCBs found:	-
PCBs cleaned up:	-
Petro products found:	-
Petro products cleaned:	-
Sediments found:	-
Sediments cleaned:	-
Soil affected:	-
Soil cleaned up:	-
Surface water cleaned:	-
VOCs found:	-
VOCs cleaned:	-
Cleanup other description:	-
Num. of cleanup and re-dev. jobs:	-
Past use greenspace acreage:	-
Past use residential acreage:	-
Surface Water:	-
Past use commercial acreage:	-
Past use industrial acreage:	-
Future use greenspace acreage:	-
Future use residential acreage:	-
Future use commercial acreage:	-
Future use industrial acreage:	-
Superfund Fed. landowner flag:	-
Arsenic cleaned up:	-
Cadmium cleaned up:	-
Chromium cleaned up:	-
Copper cleaned up:	-
Iron cleaned up:	-
mercury cleaned up:	-
Nickel Cleaned Up:	-
No clean up:	-
Pesticides cleaned up:	-
Selenium cleaned up:	-
SVOCs cleaned up:	-
Unknown clean up:	-
Arsenic contaminant found:	-
Cadmium contaminant found:	-
Chromium contaminant found:	-
Copper contaminant found:	-
Iron contaminant found:	-
Mercury contaminant found:	-
Nickel contaminant found:	-

Map ID
Direction
Distance
Elevation

MAP FINDINGS

Site

Database(s)

EDR ID Number
EPA ID Number

GRIJALVA EXTENSION (Continued)

1016345934

No contaminant found:	-
Pesticides contaminant found:	-
Selenium contaminant found:	-
SVOCs contaminant found:	-
Unknown contaminant found:	-
Future Use: Multistory	-
Media affected Bluiding Material:	-
Media affected indoor air:	-
Building material media cleaned up:	-
Indoor air media cleaned up:	-
Unknown media cleaned up:	-
Past Use: Multistory	Not reported
Property Description:	Previously owned by Union Pacific Railroad and was formerly an orange grove, landfill, surface mine, and materials processing plant
Below Poverty Number:	541
Below Poverty Percent:	10.38
Meidan Income:	5976
Meidan Income Number:	2167
Meidan Income Percent:	41.58
Vacant Housing Number:	134
Vacant Housing Percent:	6.66
Unemployed Number:	309
Unemployed Percent:	5.93
Name:	GRIJALVA EXTENSION
Address:	368 N. PROSPECT AVENUE
City,State,Zip:	ORANGE, CA 92869
Recipient Name:	Orange, City of
Grant Type:	Assessment
Property Number:	-
Parcel size:	27
Latitude:	33.7924
Longitude:	-117.819
HCM Label:	-
Map Scale:	-
Point of Reference:	-
Highlights:	-
Datum:	-
Acres Property ID:	12260
IC Data Access:	-
Start Date:	-
Redev Completition Date:	-
Completed Date:	-
Acres Cleaned Up:	-
Cleanup Funding:	-
Cleanup Funding Source:	-
Assessment Funding:	136664.44
Assessment Funding Source:	-
Redevelopment Funding:	8603349
Redev. Funding Source:	County
Redev. Funding Entity Name:	Local Funding
Redevelopment Start Date:	07/01/2006
Assessment Funding Entity:	US EPA - Brownfields Assessment Cooperative Agreement
Cleanup Funding Entity:	-
Grant Type:	-
Accomplishment Type:	Phase II Environmental Assessment
Accomplishment Count:	N

Map ID
Direction
Distance
Elevation

MAP FINDINGS

Site

Database(s)

EDR ID Number
EPA ID Number

GRIJALVA EXTENSION (Continued)

1016345934

Cooperative Agreement Number: 98997601
Start Date: 07/13/2005
Ownership Entity: Government
Completion Date: 07/13/2005
Current Owner: City of Orange
Did Owner Change: N
Cleanup Required: Y
Video Available: -
Photo Available: Y
Institutional Controls Required: -
IC Category Proprietary Controls: -
IC Cat. Info. Devices: -
IC Cat. Gov. Controls: -
IC Cat. Enforcement Permit Tools: -
IC in place date: -
IC in place: U
State/tribal program date: -
State/tribal program ID: -
State/tribal NFA date: -
Air cleaned: -
Asbestos found: -
Asbestos cleaned: -
Controlled substance found: -
Controlled substance cleaned: -
Drinking water affected: -
Drinking water cleaned: -
Groundwater affected: -
Groundwater cleaned: -
Lead contaminant found: -
Lead cleaned up: -
No media affected: Not reported
Unknown media affected: -
Other cleaned up: -
Other metals found: -
Other metals cleaned: -
Other contaminants found: -
Other contams found description: -
PAHs found: -
PAHs cleaned up: -
PCBs found: -
PCBs cleaned up: -
Petro products found: -
Petro products cleaned: -
Sediments found: -
Sediments cleaned: -
Soil affected: -
Soil cleaned up: -
Surface water cleaned: -
VOCs found: -
VOCs cleaned: -
Cleanup other description: -
Num. of cleanup and re-dev. jobs: -
Past use greenspace acreage: -
Past use residential acreage: -
Surface Water: -
Past use commercial acreage: -
Past use industrial acreage: -

Map ID
 Direction
 Distance
 Elevation

MAP FINDINGS

Site

Database(s)

EDR ID Number
 EPA ID Number

GRIJALVA EXTENSION (Continued)

1016345934

Future use greenspace acreage:	-
Future use residential acreage:	-
Future use commercial acreage:	-
Future use industrial acreage:	-
Superfund Fed. landowner flag:	-
Arsenic cleaned up:	-
Cadmium cleaned up:	-
Chromium cleaned up:	-
Copper cleaned up:	-
Iron cleaned up:	-
mercury cleaned up:	-
Nickel Cleaned Up:	-
No clean up:	-
Pesticides cleaned up:	-
Selenium cleaned up:	-
SVOCs cleaned up:	-
Unknown clean up:	-
Arsenic contaminant found:	-
Cadmium contaminant found:	-
Chromium contaminant found:	-
Copper contaminant found:	-
Iron contaminant found:	-
Mercury contaminant found:	-
Nickel contaminant found:	-
No contaminant found:	-
Pesticides contaminant found:	-
Selenium contaminant found:	-
SVOCs contaminant found:	-
Unknown contaminant found:	-
Future Use: Multistory	-
Media affected Bluiding Material:	-
Media affected indoor air:	-
Building material media cleaned up:	-
Indoor air media cleaned up:	-
Unknown media cleaned up:	-
Past Use: Multistory	Not reported
Property Description:	Previously owned by Union Pacific Railroad and was formerly an orange grove, landfill, surface mine, and materials processing plant
Below Poverty Number:	541
Below Poverty Percent:	10.38
Meidan Income:	5976
Meidan Income Number:	2167
Meidan Income Percent:	41.58
Vacant Housing Number:	134
Vacant Housing Percent:	6.66
Unemployed Number:	309
Unemployed Percent:	5.93
Name:	GRIJALVA EXTENSION
Address:	368 N. PROSPECT AVENUE
City,State,Zip:	ORANGE, CA 92869
Recipient Name:	Orange, City of
Grant Type:	Assessment
Property Number:	-
Parcel size:	27
Latitude:	33.7924
Longitude:	-117.819

Map ID
Direction
Distance
Elevation

MAP FINDINGS

Site

Database(s)

EDR ID Number
EPA ID Number

GRIJALVA EXTENSION (Continued)

1016345934

HCM Label: -
Map Scale: -
Point of Reference: -
Highlights: -
Datum: -
Acres Property ID: 12260
IC Data Access: -
Start Date: -
Redev Completion Date: -
Completed Date: -
Acres Cleaned Up: -
Cleanup Funding: -
Cleanup Funding Source: -
Assessment Funding: -
Assessment Funding Source: -
Redevelopment Funding: 3974000
Redev. Funding Source: Cal Parks
Redev. Funding Entity Name: State/Tribal Funding (non-section 128(a))
Redevelopment Start Date: 07/01/2006
Assessment Funding Entity: -
Cleanup Funding Entity: -
Grant Type: -
Accomplishment Type: Phase I Environmental Assessment
Accomplishment Count: N
Cooperative Agreement Number: 98997601
Start Date: 01/01/2001
Ownership Entity: Government
Completion Date: 01/01/2001
Current Owner: City of Orange
Did Owner Change: N
Cleanup Required: Y
Video Available: -
Photo Available: Y
Institutional Controls Required: -
IC Category Proprietary Controls: -
IC Cat. Info. Devices: -
IC Cat. Gov. Controls: -
IC Cat. Enforcement Permit Tools: -
IC in place date: -
IC in place: U
State/tribal program date: -
State/tribal program ID: -
State/tribal NFA date: -
Air cleaned: -
Asbestos found: -
Asbestos cleaned: -
Controlled substance found: -
Controlled substance cleaned: -
Drinking water affected: -
Drinking water cleaned: -
Groundwater affected: -
Groundwater cleaned: -
Lead contaminant found: -
Lead cleaned up: -
No media affected: Not reported
Unknown media affected: -
Other cleaned up: -

Map ID
Direction
Distance
Elevation

MAP FINDINGS

Site

Database(s)

EDR ID Number
EPA ID Number

GRIJALVA EXTENSION (Continued)

1016345934

Other metals found: -
Other metals cleaned: -
Other contaminants found: -
Other contams found description: -
PAHs found: -
PAHs cleaned up: -
PCBs found: -
PCBs cleaned up: -
Petro products found: -
Petro products cleaned: -
Sediments found: -
Sediments cleaned: -
Soil affected: -
Soil cleaned up: -
Surface water cleaned: -
VOCs found: -
VOCs cleaned: -
Cleanup other description: -
Num. of cleanup and re-dev. jobs: -
Past use greenspace acreage: -
Past use residential acreage: -
Surface Water: -
Past use commercial acreage: -
Past use industrial acreage: -
Future use greenspace acreage: -
Future use residential acreage: -
Future use commercial acreage: -
Future use industrial acreage: -
Superfund Fed. landowner flag: -
Arsenic cleaned up: -
Cadmium cleaned up: -
Chromium cleaned up: -
Copper cleaned up: -
Iron cleaned up: -
mercury cleaned up: -
Nickel Cleaned Up: -
No clean up: -
Pesticides cleaned up: -
Selenium cleaned up: -
SVOCs cleaned up: -
Unknown clean up: -
Arsenic contaminant found: -
Cadmium contaminant found: -
Chromium contaminant found: -
Copper contaminant found: -
Iron contaminant found: -
Mercury contaminant found: -
Nickel contaminant found: -
No contaminant found: -
Pesticides contaminant found: -
Selenium contaminant found: -
SVOCs contaminant found: -
Unknown contaminant found: -
Future Use: Multistory -
Media affected Bluiding Material: -
Media affected indoor air: -
Building material media cleaned up: -

Map ID
 Direction
 Distance
 Elevation

MAP FINDINGS

Site

Database(s)

EDR ID Number
 EPA ID Number

GRIJALVA EXTENSION (Continued)

1016345934

Indoor air media cleaned up:	-
Unknown media cleaned up:	-
Past Use: Multistory	Not reported
Property Description:	Previously owned by Union Pacific Railroad and was formerly an orange grove, landfill, surface mine, and materials processing plant
Below Poverty Number:	541
Below Poverty Percent:	10.38
Meidan Income:	5976
Meidan Income Number:	2167
Meidan Income Percent:	41.58
Vacant Housing Number:	134
Vacant Housing Percent:	6.66
Unemployed Number:	309
Unemployed Percent:	5.93
Name:	GRIJALVA EXTENSION
Address:	368 N. PROSPECT AVENUE
City,State,Zip:	ORANGE, CA 92869
Recipient Name:	Orange, City of
Grant Type:	Assessment
Property Number:	-
Parcel size:	27
Latitude:	33.7924
Longitude:	-117.819
HCM Label:	-
Map Scale:	-
Point of Reference:	-
Highlights:	-
Datum:	-
Acres Property ID:	12260
IC Data Access:	-
Start Date:	-
Redev Completion Date:	-
Completed Date:	-
Acres Cleaned Up:	-
Cleanup Funding:	-
Cleanup Funding Source:	-
Assessment Funding:	-
Assessment Funding Source:	-
Redevelopment Funding:	70000
Redev. Funding Source:	CDBG
Redev. Funding Entity Name:	Other Federal Funding
Redevelopment Start Date:	07/01/2006
Assessment Funding Entity:	-
Cleanup Funding Entity:	-
Grant Type:	-
Accomplishment Type:	Phase I Environmental Assessment
Accomplishment Count:	N
Cooperative Agreement Number:	98997601
Start Date:	01/01/2001
Ownership Entity:	Government
Completion Date:	01/01/2001
Current Owner:	City of Orange
Did Owner Change:	N
Cleanup Required:	Y
Video Available:	-
Photo Available:	Y

Map ID
Direction
Distance
Elevation

MAP FINDINGS

Site

Database(s)

EDR ID Number
EPA ID Number

GRIJALVA EXTENSION (Continued)

1016345934

Institutional Controls Required:	-
IC Category Proprietary Controls:	-
IC Cat. Info. Devices:	-
IC Cat. Gov. Controls:	-
IC Cat. Enforcement Permit Tools:	-
IC in place date:	-
IC in place:	U
State/tribal program date:	-
State/tribal program ID:	-
State/tribal NFA date:	-
Air cleaned:	-
Asbestos found:	-
Asbestos cleaned:	-
Controlled substance found:	-
Controlled substance cleaned:	-
Drinking water affected:	-
Drinking water cleaned:	-
Groundwater affected:	-
Groundwater cleaned:	-
Lead contaminant found:	-
Lead cleaned up:	-
No media affected:	Not reported
Unknown media affected:	-
Other cleaned up:	-
Other metals found:	-
Other metals cleaned:	-
Other contaminants found:	-
Other contaminants found description:	-
PAHs found:	-
PAHs cleaned up:	-
PCBs found:	-
PCBs cleaned up:	-
Petro products found:	-
Petro products cleaned:	-
Sediments found:	-
Sediments cleaned:	-
Soil affected:	-
Soil cleaned up:	-
Surface water cleaned:	-
VOCs found:	-
VOCs cleaned:	-
Cleanup other description:	-
Num. of cleanup and re-dev. jobs:	-
Past use greenspace acreage:	-
Past use residential acreage:	-
Surface Water:	-
Past use commercial acreage:	-
Past use industrial acreage:	-
Future use greenspace acreage:	-
Future use residential acreage:	-
Future use commercial acreage:	-
Future use industrial acreage:	-
Superfund Fed. landowner flag:	-
Arsenic cleaned up:	-
Cadmium cleaned up:	-
Chromium cleaned up:	-
Copper cleaned up:	-

Map ID
 Direction
 Distance
 Elevation

MAP FINDINGS

Site

Database(s)

EDR ID Number
 EPA ID Number

GRIJALVA EXTENSION (Continued)

1016345934

Iron cleaned up:	-
mercury cleaned up:	-
Nickel Cleaned Up:	-
No clean up:	-
Pesticides cleaned up:	-
Selenium cleaned up:	-
SVOCs cleaned up:	-
Unknown clean up:	-
Arsenic contaminant found:	-
Cadmium contaminant found:	-
Chromium contaminant found:	-
Copper contaminant found:	-
Iron contaminant found:	-
Mercury contaminant found:	-
Nickel contaminant found:	-
No contaminant found:	-
Pesticides contaminant found:	-
Selenium contaminant found:	-
SVOCs contaminant found:	-
Unknown contaminant found:	-
Future Use: Multistory	-
Media affected Bluiding Material:	-
Media affected indoor air:	-
Building material media cleaned up:	-
Indoor air media cleaned up:	-
Unknown media cleaned up:	-
Past Use: Multistory	Not reported
Property Description:	Previously owned by Union Pacific Railroad and was formerly an orange grove, landfill, surface mine, and materials processing plant
Below Poverty Number:	541
Below Poverty Percent:	10.38
Meidan Income:	5976
Meidan Income Number:	2167
Meidan Income Percent:	41.58
Vacant Housing Number:	134
Vacant Housing Percent:	6.66
Unemployed Number:	309
Unemployed Percent:	5.93
Name:	GRIJALVA EXTENSION
Address:	368 N. PROSPECT AVENUE
City,State,Zip:	ORANGE, CA 92869
Recipient Name:	Orange, City of
Grant Type:	Assessment
Property Number:	-
Parcel size:	27
Latitude:	33.7924
Longitude:	-117.819
HCM Label:	-
Map Scale:	-
Point of Reference:	-
Highlights:	-
Datum:	-
Acres Property ID:	12260
IC Data Access:	-
Start Date:	-
Redev Completion Date:	-

Map ID
Direction
Distance
Elevation

MAP FINDINGS

Site

Database(s)

EDR ID Number
EPA ID Number

GRIJALVA EXTENSION (Continued)

1016345934

Completed Date: -
Acres Cleaned Up: -
Cleanup Funding: -
Cleanup Funding Source: -
Assessment Funding: -
Assessment Funding Source: -
Redevelopment Funding: 8603349
Redev. Funding Source: County
Redev. Funding Entity Name: Local Funding
Redevelopment Start Date: 07/01/2006
Assessment Funding Entity: -
Cleanup Funding Entity: -
Grant Type: -
Accomplishment Type: Phase I Environmental Assessment
Accomplishment Count: N
Cooperative Agreement Number: 98997601
Start Date: 01/01/2001
Ownership Entity: Government
Completion Date: 01/01/2001
Current Owner: City of Orange
Did Owner Change: N
Cleanup Required: Y
Video Available: -
Photo Available: Y
Institutional Controls Required: -
IC Category Proprietary Controls: -
IC Cat. Info. Devices: -
IC Cat. Gov. Controls: -
IC Cat. Enforcement Permit Tools: -
IC in place date: -
IC in place: U
State/tribal program date: -
State/tribal program ID: -
State/tribal NFA date: -
Air cleaned: -
Asbestos found: -
Asbestos cleaned: -
Controlled substance found: -
Controlled substance cleaned: -
Drinking water affected: -
Drinking water cleaned: -
Groundwater affected: -
Groundwater cleaned: -
Lead contaminant found: -
Lead cleaned up: -
No media affected: Not reported
Unknown media affected: -
Other cleaned up: -
Other metals found: -
Other metals cleaned: -
Other contaminants found: -
Other contams found description: -
PAHs found: -
PAHs cleaned up: -
PCBs found: -
PCBs cleaned up: -
Petro products found: -

Map ID
 Direction
 Distance
 Elevation

MAP FINDINGS

Site

Database(s)

EDR ID Number
 EPA ID Number

GRIJALVA EXTENSION (Continued)

1016345934

Petro products cleaned:	-
Sediments found:	-
Sediments cleaned:	-
Soil affected:	-
Soil cleaned up:	-
Surface water cleaned:	-
VOCs found:	-
VOCs cleaned:	-
Cleanup other description:	-
Num. of cleanup and re-dev. jobs:	-
Past use greenspace acreage:	-
Past use residential acreage:	-
Surface Water:	-
Past use commercial acreage:	-
Past use industrial acreage:	-
Future use greenspace acreage:	-
Future use residential acreage:	-
Future use commercial acreage:	-
Future use industrial acreage:	-
Superfund Fed. landowner flag:	-
Arsenic cleaned up:	-
Cadmium cleaned up:	-
Chromium cleaned up:	-
Copper cleaned up:	-
Iron cleaned up:	-
mercury cleaned up:	-
Nickel Cleaned Up:	-
No clean up:	-
Pesticides cleaned up:	-
Selenium cleaned up:	-
SVOCs cleaned up:	-
Unknown clean up:	-
Arsenic contaminant found:	-
Cadmium contaminant found:	-
Chromium contaminant found:	-
Copper contaminant found:	-
Iron contaminant found:	-
Mercury contaminant found:	-
Nickel contaminant found:	-
No contaminant found:	-
Pesticides contaminant found:	-
Selenium contaminant found:	-
SVOCs contaminant found:	-
Unknown contaminant found:	-
Future Use: Multistory	-
Media affected Bluiding Material:	-
Media affected indoor air:	-
Building material media cleaned up:	-
Indoor air media cleaned up:	-
Unknown media cleaned up:	-
Past Use: Multistory	Not reported
Property Description:	Previously owned by Union Pacific Railroad and was formerly an orange grove, landfill, surface mine, and materials processing plant
Below Poverty Number:	541
Below Poverty Percent:	10.38
Meidan Income:	5976
Meidan Income Number:	2167

Map ID
 Direction
 Distance
 Elevation

MAP FINDINGS

Site

Database(s)

EDR ID Number
 EPA ID Number

GRIJALVA EXTENSION (Continued)

1016345934

Meidan Income Percent: 41.58
 Vacant Housing Number: 134
 Vacant Housing Percent: 6.66
 Unemployed Number: 309
 Unemployed Percent: 5.93

FINDS:

Registry ID: 110038701438

Click Here:

Environmental Interest/Information System:

US EPA Assessment, Cleanup and Redevelopment Exchange System (ACRES) is a federal online database for Brownfields Grantees to electronically submit data directly to EPA.

[Click this hyperlink](#) while viewing on your computer to access additional FINDS: detail in the EDR Site Report.

**F29
 SSW
 1/4-1/2
 0.402 mi.
 2125 ft.**

**GRIJALVA SITE
 368 N PROSPECT ST.
 ORANGE, CA**

**CPS-SLIC S108985897
 N/A**

Site 2 of 2 in cluster F

**Relative:
 Lower
 Actual:
 279 ft.**

SLIC REG 8:
 Name: GRIJALVA SITE
 Address: 368 N PROSPECT ST.
 City: ORANGE
 Type: Not reported
 Facility Status: 39574
 Staff: RA
 Substance: LEAD
 Lead Agency: RB8
 Location Code: Not reported
 Thomas Bros Code: Not reported

**G30
 SSE
 1/4-1/2
 0.461 mi.
 2435 ft.**

**EL MODENA HIGH SCHOOL
 3920 SPRING ST
 ORANGE, CA 92869**

**RCRA-SQG 1000301017
 LUST CAD981430424
 FINDS
 HIST CORTESE**

Site 1 of 2 in cluster G

**Relative:
 Lower
 Actual:
 286 ft.**

RCRA-SQG:
 Date Form Received by Agency: 1986-06-24 00:00:00.0
 Handler Name: EL MODENA HIGH SCHOOL
 Handler Address: 3920 SPRING ST
 Handler City,State,Zip: ORANGE, CA 92869
 EPA ID: CAD981430424
 Contact Name: ENVIRONMENTAL MANAGER
 Contact Address: 3920 SPRING ST
 Contact City,State,Zip: ORANGE, CA 92669
 Contact Telephone: 714-997-6331
 Contact Fax: Not reported
 Contact Email: Not reported
 Contact Title: Not reported
 EPA Region: 09

Map ID
 Direction
 Distance
 Elevation

MAP FINDINGS

Site

Database(s)

EDR ID Number
 EPA ID Number

EL MODENA HIGH SCHOOL (Continued)

1000301017

Land Type:	Other
Federal Waste Generator Description:	Small Quantity Generator
Non-Notifier:	Not reported
Biennial Report Cycle:	Not reported
Accessibility:	Not reported
Active Site Indicator:	Handler Activities
State District Owner:	CA
State District:	4
Mailing Address:	370 N GLASSELL ST
Mailing City, State, Zip:	ORANGE, CA 92666
Owner Name:	ORANGE USD
Owner Type:	District
Operator Name:	NOT REQUIRED
Operator Type:	District
Short-Term Generator Activity:	No
Importer Activity:	No
Mixed Waste Generator:	No
Transporter Activity:	No
Transfer Facility Activity:	No
Recycler Activity with Storage:	No
Small Quantity On-Site Burner Exemption:	No
Smelting Melting and Refining Furnace Exemption:	No
Underground Injection Control:	No
Off-Site Waste Receipt:	No
Universal Waste Indicator:	No
Universal Waste Destination Facility:	No
Federal Universal Waste:	No
Active Site Fed-Reg Treatment Storage and Disposal Facility:	Not reported
Active Site Converter Treatment storage and Disposal Facility:	Not reported
Active Site State-Reg Treatment Storage and Disposal Facility:	Not reported
Active Site State-Reg Handler:	---
Federal Facility Indicator:	Not reported
Hazardous Secondary Material Indicator:	N
Sub-Part K Indicator:	Not reported
Commercial TSD Indicator:	No
Treatment Storage and Disposal Type:	Not reported
2018 GPRA Permit Baseline:	Not on the Baseline
2018 GPRA Renewals Baseline:	Not on the Baseline
Permit Renewals Workload Universe:	Not reported
Permit Workload Universe:	Not reported
Permit Progress Universe:	Not reported
Post-Closure Workload Universe:	Not reported
Closure Workload Universe:	Not reported
202 GPRA Corrective Action Baseline:	No
Corrective Action Workload Universe:	No
Subject to Corrective Action Universe:	No
Non-TSDs Where RCRA CA has Been Imposed Universe:	No
TSDs Potentially Subject to CA Under 3004 (u)/(v) Universe:	No
TSDs Only Subject to CA under Discretionary Auth Universe:	No
Corrective Action Priority Ranking:	No NCAPS ranking
Environmental Control Indicator:	No
Institutional Control Indicator:	No
Human Exposure Controls Indicator:	N/A
Groundwater Controls Indicator:	N/A
Operating TSD Universe:	Not reported
Full Enforcement Universe:	Not reported
Significant Non-Complier Universe:	No

Map ID
Direction
Distance
Elevation

MAP FINDINGS

Site

Database(s)

EDR ID Number
EPA ID Number

EL MODENA HIGH SCHOOL (Continued)

1000301017

Unaddressed Significant Non-Complier Universe: No
Addressed Significant Non-Complier Universe: No
Significant Non-Complier With a Compliance Schedule Universe: No
Financial Assurance Required: Not reported
Handler Date of Last Change: 2002-06-27 03:25:04.0
Recognized Trader-Importer: No
Recognized Trader-Exporter: No
Importer of Spent Lead Acid Batteries: No
Exporter of Spent Lead Acid Batteries: No
Recycler Activity Without Storage: No
Manifest Broker: No
Sub-Part P Indicator: No

Handler - Owner Operator:

Owner/Operator Indicator: Operator
Owner/Operator Name: NOT REQUIRED
Legal Status: District
Date Became Current: Not reported
Date Ended Current: Not reported
Owner/Operator Address: NOT REQUIRED
Owner/Operator City,State,Zip: NOT REQUIRED, ME 99999
Owner/Operator Telephone: 415-555-1212
Owner/Operator Telephone Ext: Not reported
Owner/Operator Fax: Not reported
Owner/Operator Email: Not reported

Owner/Operator Indicator: Owner
Owner/Operator Name: ORANGE USD
Legal Status: District
Date Became Current: Not reported
Date Ended Current: Not reported
Owner/Operator Address: NOT REQUIRED
Owner/Operator City,State,Zip: NOT REQUIRED, ME 99999
Owner/Operator Telephone: 415-555-1212
Owner/Operator Telephone Ext: Not reported
Owner/Operator Fax: Not reported
Owner/Operator Email: Not reported

Historic Generators:

Receive Date: 1986-06-24 00:00:00.0
Handler Name: EL MODENA HIGH SCHOOL
Federal Waste Generator Description: Small Quantity Generator
State District Owner: CA
Large Quantity Handler of Universal Waste: No
Recognized Trader Importer: No
Recognized Trader Exporter: No
Spent Lead Acid Battery Importer: No
Spent Lead Acid Battery Exporter: No
Current Record: Yes
Non Storage Recycler Activity: Not reported
Electronic Manifest Broker: Not reported

List of NAICS Codes and Descriptions:

NAICS Code: 61111
NAICS Description: ELEMENTARY AND SECONDARY SCHOOLS

Map ID
Direction
Distance
Elevation

MAP FINDINGS

Site

Database(s)

EDR ID Number
EPA ID Number

EL MODENA HIGH SCHOOL (Continued)

1000301017

Facility Has Received Notices of Violations:

Violations: No Violations Found

Evaluation Action Summary:

Evaluations: No Evaluations Found

LUST REG 8:

Name: EL MODENA HIGH SCHOOL
Address: 3920 SPRING
City: ORANGE
Region: 8
County: Orange
Regional Board: Santa Ana Region
Facility Status: Case Closed
Case Number: 083001191T
Local Case Num: Not reported
Case Type: Soil only
Substance: Waste Oil
Qty Leaked: Not reported
Abate Method: Not reported
Cross Street: ESPLANADE
Enf Type: CLOS
Funding: Not reported
How Discovered: Tank Closure
How Stopped: Not reported
Leak Cause: UNK
Leak Source: UNK
Global ID: T0605900933
How Stopped Date: 1/2/1992
Enter Date: 2/11/1992
Date Confirmation of Leak Began: 1/21/1992
Date Preliminary Assessment Began: 4/16/1992
Discover Date: 1/21/1992
Enforcement Date: Not reported
Close Date: 12/29/1992
Date Prelim Assessment Workplan Submitted: 2/26/1992
Date Pollution Characterization Began: Not reported
Date Remediation Plan Submitted: 5/3/1992
Date Remedial Action Underway: 5/3/1992
Date Post Remedial Action Monitoring: Not reported
Enter Date: 2/11/1992
GW Qualifies: Not reported
Soil Qualifies: Not reported
Operator: Not reported
Facility Contact: Not reported
Interim: Not reported
Oversite Program: LUST
Latitude: 33.7912039
Longitude: -117.8111025
MTBE Date: Not reported
Max MTBE GW: Not reported
MTBE Concentration: 0
Max MTBE Soil: Not reported
MTBE Fuel: 0
MTBE Tested: Not Required to be Tested.

Map ID
 Direction
 Distance
 Elevation

MAP FINDINGS

Site

Database(s)

EDR ID Number
 EPA ID Number

EL MODENA HIGH SCHOOL (Continued)

1000301017

MTBE Class: *

Staff: PAH

Staff Initials: UNK

Lead Agency: Local Agency

Local Agency: Orange, Orange County

Hydr Basin #: COASTAL PLAIN OF ORA

Beneficial: Not reported

Priority: Not reported

Cleanup Fund Id: Not reported

Work Suspended: Not reported

Summary: WAITING TILL THE END OF SCHOOL BEFORE REMEDIATING

FINDS:

Registry ID: 110008268800

Click Here:

Environmental Interest/Information System:

RCRAInfo is a national information system that supports the Resource Conservation and Recovery Act (RCRA) program through the tracking of events and activities related to facilities that generate, transport, and treat, store, or dispose of hazardous waste. RCRAInfo allows RCRA program staff to track the notification, permit, compliance, and corrective action activities required under RCRA.

[Click this hyperlink](#) while viewing on your computer to access additional FINDS: detail in the EDR Site Report.

HIST CORTESE:

edr_fname: EL MODENA HIGH SCHOOL

edr_fadd1: 3920 SPRING

City,State,Zip: ORANGE, CA 92669

Region: CORTESE

Facility County Code: 30

Reg By: LTNKA

Reg Id: 083001191T

G31
SSE
 1/4-1/2
 0.461 mi.
 2435 ft.

EL MODENA HIGH SCHOOL
3920 E SPRING
ORANGE, CA 92669
Site 2 of 2 in cluster G

LUST **S109284357**
Cortese **N/A**
CERS

Relative:
Lower
Actual:
286 ft.

LUST:

Name: EL MODENA HIGH SCHOOL

Address: 3920 E SPRING

City,State,Zip: ORANGE, CA 92669

Lead Agency: ORANGE, CITY OF

Case Type: LUST Cleanup Site

Geo Track: http://geotracker.waterboards.ca.gov/profile_report.asp?global_id=T0605900933

Global Id: T0605900933

Latitude: 33.789992

Longitude: -117.812503

Status: Completed - Case Closed

Status Date: 12/29/1992

Case Worker: UNK

RB Case Number: 083001191T

Local Agency: ORANGE, CITY OF

Map ID
Direction
Distance
Elevation

MAP FINDINGS

Site

Database(s)

EDR ID Number
EPA ID Number

EL MODENA HIGH SCHOOL (Continued)

S109284357

File Location: Not reported
Local Case Number: Not reported
Potential Media Affect: Soil
Potential Contaminants of Concern: Waste Oil / Motor / Hydraulic / Lubricating
Site History: Not reported

LUST:

Global Id: T0605900933
Contact Type: Regional Board Caseworker
Contact Name: PATRICIA HANNON
Organization Name: SANTA ANA RWQCB (REGION 8)
Address: 3737 MAIN STREET, SUITE 500
City: RIVERSIDE
Email: patricia.hannon@waterboards.ca.gov
Phone Number: Not reported

Global Id: T0605900933
Contact Type: Local Agency Caseworker
Contact Name: UNK
Organization Name: ORANGE, CITY OF
Address: Not reported
City: r8 UNKNOWN
Email: Not reported
Phone Number: Not reported

LUST:

Global Id: T0605900933
Action Type: ENFORCEMENT
Date: 12/29/1992
Action: Closure/No Further Action Letter

Global Id: T0605900933
Action Type: Other
Date: 01/21/1992
Action: Leak Discovery

Global Id: T0605900933
Action Type: Other
Date: 01/02/1992
Action: Leak Stopped

Global Id: T0605900933
Action Type: Other
Date: 01/22/1992
Action: Leak Reported

LUST:

Global Id: T0605900933
Status: Open - Case Begin Date
Status Date: 01/02/1992

Global Id: T0605900933
Status: Open - Site Assessment
Status Date: 01/21/1992

Global Id: T0605900933
Status: Open - Site Assessment

Map ID
Direction
Distance
Elevation

MAP FINDINGS

Site

Database(s)

EDR ID Number
EPA ID Number

EL MODENA HIGH SCHOOL (Continued)

S109284357

Status Date: 02/26/1992

Global Id: T0605900933
Status: Open - Site Assessment
Status Date: 04/16/1992

Global Id: T0605900933
Status: Open - Remediation
Status Date: 05/03/1992

Global Id: T0605900933
Status: Completed - Case Closed
Status Date: 12/29/1992

CORTESE:

Name: EL MODENA HIGH SCHOOL
Address: 3920 E SPRING
City,State,Zip: ORANGE, CA 92669
Region: CORTESE
Envirostor Id: Not reported
Global ID: T0605900933
Site/Facility Type: LUST CLEANUP SITE
Cleanup Status: COMPLETED - CASE CLOSED
Status Date: Not reported
Site Code: Not reported
Latitude: Not reported
Longitude: Not reported
Owner: Not reported
Enf Type: Not reported
Swat R: Not reported
Flag: active
Order No: Not reported
Waste Discharge System No: Not reported
Effective Date: Not reported
Region 2: Not reported
WID Id: Not reported
Solid Waste Id No: Not reported
Waste Management Uit Name: Not reported
File Name: Active Open

CERS:

Name: EL MODENA HIGH SCHOOL
Address: 3920 E SPRING
City,State,Zip: ORANGE, CA 92669
Site ID: 187209
CERS ID: T0605900933
CERS Description: Leaking Underground Storage Tank Cleanup Site

Affiliation:

Affiliation Type Desc: Local Agency Caseworker
Entity Name: UNK - ORANGE, CITY OF
Entity Title: Not reported
Affiliation Address: Not reported
Affiliation City: r8 UNKNOWN
Affiliation State: CA
Affiliation Country: Not reported

Map ID
 Direction
 Distance
 Elevation

MAP FINDINGS

Site

Database(s)

EDR ID Number
 EPA ID Number

EL MODENA HIGH SCHOOL (Continued)

S109284357

Affiliation Zip:	Not reported
Affiliation Phone:	Not reported
Affiliation Type Desc:	Regional Board Caseworker
Entity Name:	PATRICIA HANNON - SANTA ANA RWQCB (REGION 8)
Entity Title:	Not reported
Affiliation Address:	3737 MAIN STREET, SUITE 500
Affiliation City:	RIVERSIDE
Affiliation State:	CA
Affiliation Country:	Not reported
Affiliation Zip:	Not reported
Affiliation Phone:	Not reported

32
SSW
1/4-1/2
0.476 mi.
2515 ft.

CITY OF ORANGE SANTIAGO CREEK LANDFILL
PROSPECT AND SPRING STREETS (NW CORNER)
ORANGE, CA 92869

SWF/LF **S105003794**
CERS **N/A**

Relative:
Lower
Actual:
276 ft.

SWF/LF (SWIS):	
Name:	CITY OF ORANGE SANTIAGO CREEK LANDFILL
Address:	PROSPECT AND SPRING STREETS (NW CORNER)
City,State,Zip:	ORANGE, CA 92869
Region:	STATE
Facility ID:	30-CR-0164
SWIS Number:	30-CR-0164
Point of Contact:	Abel Martinez-Centeno
Is Archived:	No
Is Closed Illegal Abandoned:	Yes
Is Site Inert Debris Engineered Fill:	No
Is Financial Assurances Responsible:	No
Absorbed On:	Not reported
Operational Status:	Closed
Absorbed By:	Not reported
Closed Illegal Abandoned Category:	C1
EPA Federal Registry ID:	Not reported
ARB District:	South Coast
SWRCB Region:	Santa Ana
Local Government:	Orange
Reporting Agency Legal Name:	County of Orange
Reporting Agency Department:	Health Care Agency, Environmental Health Division
Enforcing Agency Legal Name:	County of Orange
Enforcing Agency Department:	Health Care Agency, Environmental Health Division
Regulation Status:	Pre-regulation
Activity:	
SWIS Number:	30-CR-0164
Site Name:	City of Orange Santiago Creek Landfill
Activity:	Solid Waste Disposal Site
Activity Is Archived:	No
Category:	Disposal
Activity Classification:	Solid Waste Disposal Site
WDR Number:	Not reported
WDR Landfill Class:	Not reported
Cease Operation:	12/31/1969
Cease Operation Type:	Estimated
Inspection Frequency:	Quarterly

Map ID
Direction
Distance
Elevation

MAP FINDINGS

Site

Database(s)

EDR ID Number
EPA ID Number

CITY OF ORANGE SANTIAGO CREEK LANDFILL (Continued)

S105003794

Throughput: 0
Throughput Units: Not reported
Remaining Capacity: 0
Remaining Capacity Date: Not reported
Capacity: 0
Capacity Units: Not reported
Total Acreage: 0
Disposal Acreage: 0
Permitted Elevation: 0
Permitted Elevation Type: Not reported
Permitted Depth: 0
Permitted Depth Type: Not reported
Point of Contact: Abel Martinez-Centeno
Site Operational Status: Closed
Site Regulatory Status: Pre-regulation
Site Is Archived: No
Is Closed Illegal Abandoned: Yes
Is Site Inert Debris Engineered Fill: No
Is Financial Assurances Responsible: No
Absorbed On: Not reported
Absorbed By: Not reported
Closed Illegal Abandoned Category: C1
EPA Federal Registry ID: Not reported
County: Orange
ARB District: South Coast
SWRCB Region: Santa Ana
Local Government: Orange
Street Address: Prospect And Spring Streets (Nw Corner)
City: Orange
State: CA
ZIP Code: 92869
Reporting Agency Legal Name: County of Orange
Reporting Agency Department: Health Care Agency, Environmental Health Division
Enforcing Agency Legal Name: County of Orange
Enforcing Agency Department: Health Care Agency, Environmental Health Division

Operator:
SWIS Number: 30-CR-0164
Site Name: City of Orange Santiago Creek Landfill
Site Operational Status: Closed
Site Type: Disposal Only
Site Regulatory Status: Pre-regulation
Latitude: 33.79361
Longitude: -117.82194
Is Archived: No
Operator: City Of Orange
Started On: 3/19/2001
Contact Name: Not reported
Contact Title: Not reported
Contact Email: Not reported
Contact Phone: (714) 744-5597
Street Address: 300 E Chapman Ave
Operator City: Orange
Operator State: CA
Operator Zip: 92866

Map ID
Direction
Distance
Elevation

MAP FINDINGS

Site

Database(s)

EDR ID Number
EPA ID Number

CITY OF ORANGE SANTIAGO CREEK LANDFILL (Continued)

S105003794

Owner:

SWIS Number: 30-CR-0164
Owner: City Of Orange
Owner Address: 300 E Chapman Ave
Owner City: Orange
Owner State: CA
Owner Zip: 92866
Site Name: City of Orange Santiago Creek Landfill
Site Operational Status: Closed
Site Type: Disposal Only
Site Regulatory Status: Pre-regulation
Latitude: 33.79361
Longitude: -117.82194
Is Archived: No
Started On: 6/30/1998
Contact Name: Not reported
Contact Title: Not reported
Contact Email: Not reported
Contact Phone: (714) 744-5597

CERS:

Name: CITY OF ORANGE SANTIAGO CREEK LANDFILL
Address: PROSPECT AND SPRING STREETS (NW CORNER)
City,State,Zip: ORANGE, CA
Site ID: 507799
CERS ID: 30-CR-0164
CERS Description: Solid Waste and Recycle Sites

Affiliation:

Affiliation Type Desc: Legal Operator
Entity Name: City of Orange
Entity Title: Not reported
Affiliation Address: Greg Warren300 E. Chapman Ave.
Affiliation City: Orange
Affiliation State: CA
Affiliation Country: Not reported
Affiliation Zip: 92886
Affiliation Phone: 7147445597

Affiliation Type Desc: Legal Owner
Entity Name: City of Orange
Entity Title: Not reported
Affiliation Address: Greg Warren300 E. Chapman Ave.
Affiliation City: Orange
Affiliation State: CA
Affiliation Country: Not reported
Affiliation Zip: 92886
Affiliation Phone: 7147445597

Map ID
Direction
Distance
Elevation

MAP FINDINGS

Site

Database(s)

EDR ID Number
EPA ID Number

33
South
1/2-1
0.701 mi.
3703 ft.

DANNY'S CLEANERS 2
3534 E CHAPMAN AVE
ORANGE, CA 92869

ENVIROSTOR
VCP
DRYCLEANERS
HAZNET
HWTS

S113147218
N/A

Relative:
Lower
Actual:
274 ft.

ENVIROSTOR:
Name: CHAPMAN PATEL CLEANERS
Address: 3534 E. CHAPMAN AVENUE
City,State,Zip: ORANGE, CA 92869
Facility ID: 60002428
Status: Active
Status Date: 03/26/2020
Site Code: 401761
Site Type: Voluntary Cleanup
Site Type Detailed: Voluntary Cleanup
Acres: 1.17
NPL: NO
Regulatory Agencies: SMBRP
Lead Agency: SMBRP
Program Manager: Rana Georges
Supervisor: Yolanda Garza
Division Branch: Southern California Schools & Brownfields Outreach
Assembly: , 68
Senate: , 37
Special Program: Voluntary Cleanup Program
Restricted Use: NO
Site Mgmt Req: NONE SPECIFIED
Funding: Responsible Party
Latitude: 33.78731
Longitude: -117.8154
APN: 094-091-26
Past Use: NONE SPECIFIED
Potential COC: NONE SPECIFIED
Confirmed COC: NONE SPECIFIED
Potential Description: NONE SPECIFIED
Alias Name: Tip Top Cleaners (Former)
Alias Type: Alternate Name
Alias Name: 094-091-26
Alias Type: APN
Alias Name: 401761
Alias Type: Project Code (Site Code)
Alias Name: 60002428
Alias Type: Envirostor ID Number

Completed Info:

Completed Area Name: PROJECT WIDE
Completed Sub Area Name: Not reported
Completed Document Type: Application
Completed Date: 02/04/2020
Comments: Not reported

Completed Area Name: PROJECT WIDE
Completed Sub Area Name: Not reported
Completed Document Type: Other Report
Completed Date: 10/09/2020
Comments: DTSC comments and identified data gaps discussed during scoping meeting with proponent and their consultant.

Completed Area Name: PROJECT WIDE

Map ID
Direction
Distance
Elevation

MAP FINDINGS

Site

Database(s)

EDR ID Number
EPA ID Number

DANNY'S CLEANERS 2 (Continued)

S113147218

Completed Sub Area Name: Not reported
Completed Document Type: Correspondence
Completed Date: 01/27/2020
Comments: Not reported

Completed Area Name: PROJECT WIDE
Completed Sub Area Name: Not reported
Completed Document Type: Standard Voluntary Agreement
Completed Date: 09/02/2020
Comments: SVA executed.

Completed Area Name: PROJECT WIDE
Completed Sub Area Name: Not reported
Completed Document Type: Pre-HARP Form
Completed Date: 10/12/2020
Comments: Singed Pre-HARP.

Future Area Name: PROJECT WIDE
Future Sub Area Name: Not reported
Future Document Type: Site Characterization Report
Future Due Date: 2022
Schedule Area Name: Not reported
Schedule Sub Area Name: Not reported
Schedule Document Type: Not reported
Schedule Due Date: Not reported
Schedule Revised Date: Not reported

VCP:

Name: CHAPMAN PATEL CLEANERS
Address: 3534 E. CHAPMAN AVENUE
City,State,Zip: ORANGE, CA 92869
Facility ID: 60002428
Site Type: Voluntary Cleanup
Site Type Detail: Voluntary Cleanup
Site Mgmt. Req.: NONE SPECIFIED
Acres: 1.17
National Priorities List: NO
Cleanup Oversight Agencies: SMBRP
Lead Agency: SMBRP
Lead Agency Description: DTSC - Site Cleanup Program
Project Manager: Rana Georges
Supervisor: Yolanda Garza
Division Branch: Southern California Schools & Brownfields Outreach
Site Code: 401761
Assembly: , 68
Senate: , 37
Special Programs Code: Voluntary Cleanup Program
Status: Active
Status Date: 03/26/2020
Restricted Use: NO
Funding: Responsible Party
Lat/Long: 33.78731 / -117.8154
APN: 094-091-26
Past Use: NONE SPECIFIED
Potential COC: NONE SPECIFIED
Confirmed COC: NONE SPECIFIED
Potential Description: NONE SPECIFIED

Map ID
Direction
Distance
Elevation

MAP FINDINGS

Site

Database(s)

EDR ID Number
EPA ID Number

DANNY'S CLEANERS 2 (Continued)

S113147218

Alias Name: Tip Top Cleaners (Former)
Alias Type: Alternate Name
Alias Name: 094-091-26
Alias Type: APN
Alias Name: 401761
Alias Type: Project Code (Site Code)
Alias Name: 60002428
Alias Type: Envirostor ID Number

Completed Info:

Completed Area Name: PROJECT WIDE
Completed Sub Area Name: Not reported
Completed Document Type: Application
Completed Date: 02/04/2020
Comments: Not reported

Completed Area Name: PROJECT WIDE
Completed Sub Area Name: Not reported
Completed Document Type: Other Report
Completed Date: 10/09/2020
Comments: DTSC comments and identified data gaps discussed during scoping meeting with proponent and their consultant.

Completed Area Name: PROJECT WIDE
Completed Sub Area Name: Not reported
Completed Document Type: Correspondence
Completed Date: 01/27/2020
Comments: Not reported

Completed Area Name: PROJECT WIDE
Completed Sub Area Name: Not reported
Completed Document Type: Standard Voluntary Agreement
Completed Date: 09/02/2020
Comments: SVA executed.

Completed Area Name: PROJECT WIDE
Completed Sub Area Name: Not reported
Completed Document Type: Pre-HARP Form
Completed Date: 10/12/2020
Comments: Singed Pre-HARP.

Future Area Name: PROJECT WIDE
Future Sub Area Name: Not reported
Future Document Type: Site Characterization Report
Future Due Date: 2022
Schedule Area Name: Not reported
Schedule Sub Area Name: Not reported
Schedule Document Type: Not reported
Schedule Due Date: Not reported
Schedule Revised Date: Not reported

DRYCLEANERS:

Name: DANNYS CLEANERS 2
Address: 3534 E CHAPMAN AVE
City,State,Zip: ORANGE, CA 92869
EPA Id: CAL000450526
NAICS Code: 812320

Map ID
Direction
Distance
Elevation

MAP FINDINGS

Site

Database(s)

EDR ID Number
EPA ID Number

DANNY'S CLEANERS 2 (Continued)

S113147218

NAICS Description: Drycleaning and Laundry Services (except Coin-Operated)
SIC Code: 7211
SIC Description: Power Laundries, Family and Commercial
Create Date: 11/13/2019
Facility Active: Yes
Inactive Date: Not reported
Facility Addr2: Not reported
Owner Name: SEONG JOO
Owner Address: 20255 CHANTI CT
Owner Address 2: Not reported
Owner Telephone: 7145925075
Contact Name: SEONG JOO
Contact Address: 3534 E CHAPMAN AVE
Contact Address 2: Not reported
Contact Telephone: 7145925075
Contact Fax: Not reported
Mailing Name: Not reported
Mailing Address 1: 3534 E CHAPMAN AVE
Mailing Address 2: Not reported
Mailing City: ORANGE
Mailing State: CA
Mailing Zip: 92869
Owner Fax: Not reported
Region Code: 4
Latitude: 0
Longitude: 0

DRYCLEAN SOUTH COAST:

Name: DANNY'S CLEANERS 2
Address: 3534 E CHAPMAN AVE
City,State,Zip: ORANGE, CA 92869
Facility ID: 191179
Application Number: 616827
Permit Number: G59647
Status: A
Representative Name: SEONG JOO
Representative Telephone: 714 5925075
Permit Status: ACTIVE
BCAT Number: 000233
BCAT Description: DRY CLEANING EQUIP PETROLEUM SOLVENT
CCAT Number: Not reported
CCAT Description: Not reported
UTM East: 424.45001221
UTM North: 3738.7299805
Application Date: 10/30/2019
PO Issue Date: 12/01/2019
NAICS Code: 812320
SIC Code: 7212

HAZNET:

Name: BONDED CLEANERS
Address: 3534 E CHAPMAN AVE
Address 2: Not reported
City,State,Zip: ORANGE, CA 928693815
Contact: MARCOS GONZALEZ
Telephone: 7147449105

Map ID
Direction
Distance
Elevation

MAP FINDINGS

Site

Database(s)

EDR ID Number
EPA ID Number

DANNY'S CLEANERS 2 (Continued)

S113147218

Mailing Name: Not reported
Mailing Address: 3534 E CHAPMAN AVE

Year: 2008
Gepaid: CAL000318701
TSD EPA ID: CAD008302903
CA Waste Code: 211 - Halogenated solvents (chloroforms, methyl chloride, perchloroethylene, etc)
Disposal Method: -
Tons: Not reported

Year: 2008
Gepaid: CAL000318701
TSD EPA ID: CAD008302903
CA Waste Code: 741 - Liquids with halogenated organic compounds >= 1,000 Mg/L
Disposal Method: H020 - Solvents Recovery
Tons: 0.22935

Year: 2008
Gepaid: CAL000318701
TSD EPA ID: CAD008302903
CA Waste Code: 213 - Hydrocarbon solvents (benzene, hexane, Stoddard, Etc.)
Disposal Method: -
Tons: Not reported

Year: 2007
Gepaid: CAL000318701
TSD EPA ID: NVR000076158
CA Waste Code: 134 - Aqueous solution with total organic residues less than 10 percent
Disposal Method: H020 - Solvents Recovery
Tons: Not reported

Year: 2007
Gepaid: CAL000318701
TSD EPA ID: NVR000076158
CA Waste Code: 211 - Halogenated solvents (chloroforms, methyl chloride, perchloroethylene, etc)
Disposal Method: H020 - Solvents Recovery
Tons: 0.22935

Year: 2007
Gepaid: CAL000318701
TSD EPA ID: NVR000076158
CA Waste Code: 213 - Hydrocarbon solvents (benzene, hexane, Stoddard, Etc.)
Disposal Method: H020 - Solvents Recovery
Tons: Not reported

Additional Info:

Year: 2008
Gen EPA ID: CAL000318701

Shipment Date: 20080811
Creation Date: 9/25/2008 18:30:18
Receipt Date: 20080814
Manifest ID: 000403624GBF

Map ID
Direction
Distance
Elevation

MAP FINDINGS

Site

Database(s)

EDR ID Number
EPA ID Number

DANNY'S CLEANERS 2 (Continued)

S113147218

Trans EPA ID:	CAR000166827
Trans Name:	AMERICAN INDUSTRIAL SERVICES
Trans 2 EPA ID:	Not reported
Trans 2 Name:	Not reported
TSDf EPA ID:	CAD008302903
Trans Name:	VEOLIA ES TECHNICAL SOLUTIONS
TSDf Alt EPA ID:	Not reported
TSDf Alt Name:	Not reported
Waste Code Description:	211 - Halogenated solvents (chloroform, methyl chloride, perchloroethylene, etc.
RCRA Code:	F002
Meth Code:	- Not reported
Quantity Tons:	Not reported
Waste Quantity:	Not reported
Quantity Unit:	P
Additional Code 1:	Not reported
Additional Code 2:	Not reported
Additional Code 3:	Not reported
Additional Code 4:	Not reported
Additional Code 5:	Not reported
Shipment Date:	20080811
Creation Date:	9/25/2008 18:30:18
Receipt Date:	20080814
Manifest ID:	000403624GBF
Trans EPA ID:	CAR000166827
Trans Name:	AMERICAN INDUSTRIAL SERVICES
Trans 2 EPA ID:	Not reported
Trans 2 Name:	Not reported
TSDf EPA ID:	CAD008302903
Trans Name:	VEOLIA ES TECHNICAL SOLUTIONS
TSDf Alt EPA ID:	Not reported
TSDf Alt Name:	Not reported
Waste Code Description:	213 - Hydrocarbon solvents (benzene, hexane, Stoddard, etc.
RCRA Code:	Not reported
Meth Code:	- Not reported
Quantity Tons:	Not reported
Waste Quantity:	Not reported
Quantity Unit:	P
Additional Code 1:	Not reported
Additional Code 2:	Not reported
Additional Code 3:	Not reported
Additional Code 4:	Not reported
Additional Code 5:	Not reported
Shipment Date:	20080811
Creation Date:	9/25/2008 18:30:18
Receipt Date:	20080814
Manifest ID:	000403624GBF
Trans EPA ID:	CAR000166827
Trans Name:	AMERICAN INDUSTRIAL SERVICES
Trans 2 EPA ID:	Not reported
Trans 2 Name:	Not reported
TSDf EPA ID:	CAD008302903
Trans Name:	VEOLIA ES TECHNICAL SOLUTIONS
TSDf Alt EPA ID:	Not reported
TSDf Alt Name:	Not reported

Map ID
Direction
Distance
Elevation

MAP FINDINGS

Site

Database(s)

EDR ID Number
EPA ID Number

DANNY'S CLEANERS 2 (Continued)

S113147218

Waste Code Description: 211 - Halogenated solvents (chloroform, methyl chloride, perchloroethylene, etc.)
RCRA Code: D039
Meth Code: - Not reported
Quantity Tons: Not reported
Waste Quantity: Not reported
Quantity Unit: G
Additional Code 1: Not reported
Additional Code 2: Not reported
Additional Code 3: Not reported
Additional Code 4: Not reported
Additional Code 5: Not reported

Shipment Date: 20080811
Creation Date: 9/25/2008 18:30:18
Receipt Date: 20080814
Manifest ID: 000403624GBF
Trans EPA ID: CAR000166827
Trans Name: AMERICAN INDUSTRIAL SERVICES
Trans 2 EPA ID: Not reported
Trans 2 Name: Not reported
TSDf EPA ID: CAD008302903
Trans Name: VEOLIA ES TECHNICAL SOLUTIONS
TSDf Alt EPA ID: Not reported
TSDf Alt Name: Not reported
Waste Code Description: 741 - Liquids with halogenated organic compounds > 1000 mg/l
RCRA Code: F002
Meth Code: H020 - Solvents Recovery
Quantity Tons: 0.22935
Waste Quantity: 55
Quantity Unit: G
Additional Code 1: D039
Additional Code 2: Not reported
Additional Code 3: Not reported
Additional Code 4: Not reported
Additional Code 5: Not reported

Additional Info:

Year: 2007
Gen EPA ID: CAL000318701

Shipment Date: 20071128
Creation Date: 5/15/2008 18:30:08
Receipt Date: 20071203
Manifest ID: 000272321GBF
Trans EPA ID: CAR000166827
Trans Name: AMERICAN INDUSTRIAL SERVICES
Trans 2 EPA ID: CAR000161836
Trans 2 Name: TECHNICHEM INC
TSDf EPA ID: NVR000076158
Trans Name: RESOLVENT INC
TSDf Alt EPA ID: Not reported
TSDf Alt Name: Not reported
Waste Code Description: 211 - Halogenated solvents (chloroform, methyl chloride, perchloroethylene, etc.)
RCRA Code: F002
Meth Code: H020 - Solvents Recovery

Map ID
Direction
Distance
Elevation

MAP FINDINGS

Site

Database(s)

EDR ID Number
EPA ID Number

DANNY'S CLEANERS 2 (Continued)

S113147218

Quantity Tons:	Not reported
Waste Quantity:	Not reported
Quantity Unit:	Not reported
Additional Code 1:	Not reported
Additional Code 2:	Not reported
Additional Code 3:	Not reported
Additional Code 4:	Not reported
Additional Code 5:	Not reported
Shipment Date:	20071128
Creation Date:	5/15/2008 18:30:08
Receipt Date:	20071203
Manifest ID:	000272321GBF
Trans EPA ID:	CAR000166827
Trans Name:	AMERICAN INDUSTRIAL SERVICES
Trans 2 EPA ID:	CAR000161836
Trans 2 Name:	TECHNICHEM INC
TSDF EPA ID:	NVR000076158
Trans Name:	RESOLVENT INC
TSDF Alt EPA ID:	Not reported
TSDF Alt Name:	Not reported
Waste Code Description:	213 - Hydrocarbon solvents (benzene, hexane, Stoddard, etc.
RCRA Code:	Not reported
Meth Code:	H020 - Solvents Recovery
Quantity Tons:	Not reported
Waste Quantity:	Not reported
Quantity Unit:	Not reported
Additional Code 1:	Not reported
Additional Code 2:	Not reported
Additional Code 3:	Not reported
Additional Code 4:	Not reported
Additional Code 5:	Not reported
Shipment Date:	20071128
Creation Date:	5/15/2008 18:30:08
Receipt Date:	20071203
Manifest ID:	000272321GBF
Trans EPA ID:	CAR000166827
Trans Name:	AMERICAN INDUSTRIAL SERVICES
Trans 2 EPA ID:	CAR000161836
Trans 2 Name:	TECHNICHEM INC
TSDF EPA ID:	NVR000076158
Trans Name:	RESOLVENT INC
TSDF Alt EPA ID:	Not reported
TSDF Alt Name:	Not reported
Waste Code Description:	134 - Aqueous solution with <10% total organic residues
RCRA Code:	D039
Meth Code:	H020 - Solvents Recovery
Quantity Tons:	Not reported
Waste Quantity:	Not reported
Quantity Unit:	Not reported
Additional Code 1:	Not reported
Additional Code 2:	Not reported
Additional Code 3:	Not reported
Additional Code 4:	Not reported
Additional Code 5:	Not reported

Map ID
Direction
Distance
Elevation

MAP FINDINGS

Site

Database(s)

EDR ID Number
EPA ID Number

DANNY'S CLEANERS 2 (Continued)

S113147218

Shipment Date: 20071128
Creation Date: 5/15/2008 18:30:08
Receipt Date: 20071203
Manifest ID: 000272321GBF
Trans EPA ID: CAR000166827
Trans Name: AMERICAN INDUSTRIAL SERVICES
Trans 2 EPA ID: CAR000161836
Trans 2 Name: TECHNICHEM INC
TSDf EPA ID: NVR000076158
Trans Name: RESOLVENT INC
TSDf Alt EPA ID: Not reported
TSDf Alt Name: Not reported
Waste Code Description: 211 - Halogenated solvents (chloroform, methyl chloride, perchloroethylene, etc.)

RCRA Code: F002
Meth Code: H020 - Solvents Recovery
Quantity Tons: 0.22935
Waste Quantity: 55
Quantity Unit: G
Additional Code 1: Not reported
Additional Code 2: Not reported
Additional Code 3: Not reported
Additional Code 4: Not reported
Additional Code 5: Not reported

HWTS:

Name: DANNYS CLEANERS 2
Address: 3534 E CHAPMAN AVE
Address 2: Not reported
City,State,Zip: ORANGE, CA 92869
EPA ID: CAL000450526
Inactive Date: Not reported
Create Date: 11/13/2019
Last Act Date: 12/21/2020
Mailing Name: Not reported
Mailing Address: 3534 E CHAPMAN AVE
Mailing Address 2: Not reported
Mailing City,State,Zip: ORANGE, CA 92869
Owner Name: SEONG JOO
Owner Address: 20255 CHANTI CT
Owner Address 2: Not reported
Owner City,State,Zip: YORBA LINDA, CA 92886
Contact Name: SEONG JOO
Contact Address: 3534 E CHAPMAN AVE
Contact Address 2: Not reported
City,State,Zip: ORANGE, CA 92869

NAICS:

EPA ID: CAL000450526
Create Date: 2019-11-13 12:49:40.250
NAICS Code: 812320
NAICS Description: Drycleaning and Laundry Services (except Coin-Operated)
Issued EPA ID Date: 2019-11-13 12:49:40.17300
Inactive Date: Not reported
Facility Name: DANNYS CLEANERS 2
Facility Address: 3534 E CHAPMAN AVE
Facility Address 2: Not reported

Map ID
Direction
Distance
Elevation

MAP FINDINGS

Site

Database(s)

EDR ID Number
EPA ID Number

DANNY'S CLEANERS 2 (Continued)

S113147218

Facility City: ORANGE
Facility County: Not reported
Facility State: CA
Facility Zip: 92869

EPA ID: CAL000450526
Create Date: 2019-11-13 12:49:40.250
NAICS Code: 812320
NAICS Description: Drycleaning and Laundry Services (except Coin-Operated)
Issued EPA ID Date: 2019-11-13 12:49:40.17300
Inactive Date: Not reported
Facility Name: DANNYS CLEANERS 2
Facility Address: 3534 E CHAPMAN AVE
Facility Address 2: Not reported
Facility City: ORANGE
Facility County: Not reported
Facility State: CA
Facility Zip: 92869

Name: BONDED CLEANERS
Address: 3534 E CHAPMAN AVE
Address 2: Not reported
City,State,Zip: ORANGE, CA 928693815
EPA ID: CAL000318701
Inactive Date: 06/30/2007
Create Date: 04/17/2007
Last Act Date: 04/07/2010
Mailing Name: Not reported
Mailing Address: 3534 E CHAPMAN AVE
Mailing Address 2: Not reported
Mailing City,State,Zip: ORANGE, CA 928693815
Owner Name: CARLOS GONZALEZ
Owner Address: 2043 S DIRDS
Owner Address 2: Not reported
Owner City,State,Zip: SANTA ANA, CA 92707
Contact Name: MARCOS GONZALEZ
Contact Address: 3534 E CHAPMAN AVE
Contact Address 2: Not reported
City,State,Zip: ORANGE, CA 928693815

NAICS:
EPA ID: CAL000318701
Create Date: 2007-04-17 13:48:33.773
NAICS Code: 81232
NAICS Description: Drycleaning and Laundry Services (except Coin-Operated)
Issued EPA ID Date: 2007-04-17 13:48:33.72700
Inactive Date: 2007-06-30 00:00:00
Facility Name: BONDED CLEANERS
Facility Address: 3534 E CHAPMAN AVE
Facility Address 2: Not reported
Facility City: ORANGE
Facility County: Not reported
Facility State: CA
Facility Zip: 928693815

Count: 0 records.

ORPHAN SUMMARY

City	EDR ID	Site Name	Site Address	Zip	Database(s)
NO SITES FOUND					

GOVERNMENT RECORDS SEARCHED / DATA CURRENCY TRACKING

To maintain currency of the following federal and state databases, EDR contacts the appropriate governmental agency on a monthly or quarterly basis, as required.

Number of Days to Update: Provides confirmation that EDR is reporting records that have been updated within 90 days from the date the government agency made the information available to the public.

STANDARD ENVIRONMENTAL RECORDS

Federal NPL site list

NPL: National Priority List

National Priorities List (Superfund). The NPL is a subset of CERCLIS and identifies over 1,200 sites for priority cleanup under the Superfund Program. NPL sites may encompass relatively large areas. As such, EDR provides polygon coverage for over 1,000 NPL site boundaries produced by EPA's Environmental Photographic Interpretation Center (EPIC) and regional EPA offices.

Date of Government Version: 04/27/2021	Source: EPA
Date Data Arrived at EDR: 05/03/2021	Telephone: N/A
Date Made Active in Reports: 05/19/2021	Last EDR Contact: 06/04/2021
Number of Days to Update: 16	Next Scheduled EDR Contact: 07/12/2021
	Data Release Frequency: Quarterly

NPL Site Boundaries

Sources:

EPA's Environmental Photographic Interpretation Center (EPIC)
Telephone: 202-564-7333

EPA Region 1
Telephone 617-918-1143

EPA Region 6
Telephone: 214-655-6659

EPA Region 3
Telephone 215-814-5418

EPA Region 7
Telephone: 913-551-7247

EPA Region 4
Telephone 404-562-8033

EPA Region 8
Telephone: 303-312-6774

EPA Region 5
Telephone 312-886-6686

EPA Region 9
Telephone: 415-947-4246

EPA Region 10
Telephone 206-553-8665

Proposed NPL: Proposed National Priority List Sites

A site that has been proposed for listing on the National Priorities List through the issuance of a proposed rule in the Federal Register. EPA then accepts public comments on the site, responds to the comments, and places on the NPL those sites that continue to meet the requirements for listing.

Date of Government Version: 04/27/2021	Source: EPA
Date Data Arrived at EDR: 05/03/2021	Telephone: N/A
Date Made Active in Reports: 05/19/2021	Last EDR Contact: 06/04/2021
Number of Days to Update: 16	Next Scheduled EDR Contact: 07/12/2021
	Data Release Frequency: Quarterly

NPL LIENS: Federal Superfund Liens

Federal Superfund Liens. Under the authority granted the USEPA by CERCLA of 1980, the USEPA has the authority to file liens against real property in order to recover remedial action expenditures or when the property owner received notification of potential liability. USEPA compiles a listing of filed notices of Superfund Liens.

GOVERNMENT RECORDS SEARCHED / DATA CURRENCY TRACKING

Date of Government Version: 10/15/1991
Date Data Arrived at EDR: 02/02/1994
Date Made Active in Reports: 03/30/1994
Number of Days to Update: 56

Source: EPA
Telephone: 202-564-4267
Last EDR Contact: 08/15/2011
Next Scheduled EDR Contact: 11/28/2011
Data Release Frequency: No Update Planned

Federal Delisted NPL site list

Delisted NPL: National Priority List Deletions

The National Oil and Hazardous Substances Pollution Contingency Plan (NCP) establishes the criteria that the EPA uses to delete sites from the NPL. In accordance with 40 CFR 300.425.(e), sites may be deleted from the NPL where no further response is appropriate.

Date of Government Version: 04/27/2021
Date Data Arrived at EDR: 05/03/2021
Date Made Active in Reports: 05/19/2021
Number of Days to Update: 16

Source: EPA
Telephone: N/A
Last EDR Contact: 06/04/2021
Next Scheduled EDR Contact: 07/12/2021
Data Release Frequency: Quarterly

Federal CERCLIS list

FEDERAL FACILITY: Federal Facility Site Information listing

A listing of National Priority List (NPL) and Base Realignment and Closure (BRAC) sites found in the Comprehensive Environmental Response, Compensation and Liability Information System (CERCLIS) Database where EPA Federal Facilities Restoration and Reuse Office is involved in cleanup activities.

Date of Government Version: 04/03/2019
Date Data Arrived at EDR: 04/05/2019
Date Made Active in Reports: 05/14/2019
Number of Days to Update: 39

Source: Environmental Protection Agency
Telephone: 703-603-8704
Last EDR Contact: 03/30/2021
Next Scheduled EDR Contact: 07/12/2021
Data Release Frequency: Varies

SEMS: Superfund Enterprise Management System

SEMS (Superfund Enterprise Management System) tracks hazardous waste sites, potentially hazardous waste sites, and remedial activities performed in support of EPA's Superfund Program across the United States. The list was formerly known as CERCLIS, renamed to SEMS by the EPA in 2015. The list contains data on potentially hazardous waste sites that have been reported to the USEPA by states, municipalities, private companies and private persons, pursuant to Section 103 of the Comprehensive Environmental Response, Compensation, and Liability Act (CERCLA). This dataset also contains sites which are either proposed to or on the National Priorities List (NPL) and the sites which are in the screening and assessment phase for possible inclusion on the NPL.

Date of Government Version: 04/27/2021
Date Data Arrived at EDR: 05/03/2021
Date Made Active in Reports: 05/19/2021
Number of Days to Update: 16

Source: EPA
Telephone: 800-424-9346
Last EDR Contact: 06/04/2021
Next Scheduled EDR Contact: 07/26/2021
Data Release Frequency: Quarterly

Federal CERCLIS NFRAP site list

SEMS-ARCHIVE: Superfund Enterprise Management System Archive

GOVERNMENT RECORDS SEARCHED / DATA CURRENCY TRACKING

SEMS-ARCHIVE (Superfund Enterprise Management System Archive) tracks sites that have no further interest under the Federal Superfund Program based on available information. The list was formerly known as the CERCLIS-NFRAP, renamed to SEMS ARCHIVE by the EPA in 2015. EPA may perform a minimal level of assessment work at a site while it is archived if site conditions change and/or new information becomes available. Archived sites have been removed and archived from the inventory of SEMS sites. Archived status indicates that, to the best of EPA's knowledge, assessment at a site has been completed and that EPA has determined no further steps will be taken to list the site on the National Priorities List (NPL), unless information indicates this decision was not appropriate or other considerations require a recommendation for listing at a later time. The decision does not necessarily mean that there is no hazard associated with a given site; it only means that, based upon available information, the location is not judged to be potential NPL site.

Date of Government Version: 04/27/2021	Source: EPA
Date Data Arrived at EDR: 05/03/2021	Telephone: 800-424-9346
Date Made Active in Reports: 05/19/2021	Last EDR Contact: 06/04/2021
Number of Days to Update: 16	Next Scheduled EDR Contact: 07/26/2021
	Data Release Frequency: Quarterly

Federal RCRA CORRACTS facilities list

CORRACTS: Corrective Action Report

CORRACTS identifies hazardous waste handlers with RCRA corrective action activity.

Date of Government Version: 03/22/2021	Source: EPA
Date Data Arrived at EDR: 03/23/2021	Telephone: 800-424-9346
Date Made Active in Reports: 05/19/2021	Last EDR Contact: 03/23/2021
Number of Days to Update: 57	Next Scheduled EDR Contact: 07/05/2021
	Data Release Frequency: Quarterly

Federal RCRA non-CORRACTS TSD facilities list

RCRA-TSDF: RCRA - Treatment, Storage and Disposal

RCRAInfo is EPA's comprehensive information system, providing access to data supporting the Resource Conservation and Recovery Act (RCRA) of 1976 and the Hazardous and Solid Waste Amendments (HSWA) of 1984. The database includes selective information on sites which generate, transport, store, treat and/or dispose of hazardous waste as defined by the Resource Conservation and Recovery Act (RCRA). Transporters are individuals or entities that move hazardous waste from the generator offsite to a facility that can recycle, treat, store, or dispose of the waste. TSDFs treat, store, or dispose of the waste.

Date of Government Version: 03/22/2021	Source: Environmental Protection Agency
Date Data Arrived at EDR: 03/23/2021	Telephone: (415) 495-8895
Date Made Active in Reports: 05/19/2021	Last EDR Contact: 03/23/2021
Number of Days to Update: 57	Next Scheduled EDR Contact: 07/05/2021
	Data Release Frequency: Quarterly

Federal RCRA generators list

RCRA-LQG: RCRA - Large Quantity Generators

RCRAInfo is EPA's comprehensive information system, providing access to data supporting the Resource Conservation and Recovery Act (RCRA) of 1976 and the Hazardous and Solid Waste Amendments (HSWA) of 1984. The database includes selective information on sites which generate, transport, store, treat and/or dispose of hazardous waste as defined by the Resource Conservation and Recovery Act (RCRA). Large quantity generators (LQGs) generate over 1,000 kilograms (kg) of hazardous waste, or over 1 kg of acutely hazardous waste per month.

Date of Government Version: 03/22/2021	Source: Environmental Protection Agency
Date Data Arrived at EDR: 03/23/2021	Telephone: (415) 495-8895
Date Made Active in Reports: 05/19/2021	Last EDR Contact: 03/23/2021
Number of Days to Update: 57	Next Scheduled EDR Contact: 07/05/2021
	Data Release Frequency: Quarterly

GOVERNMENT RECORDS SEARCHED / DATA CURRENCY TRACKING

RCRA-SQG: RCRA - Small Quantity Generators

RCRAInfo is EPA's comprehensive information system, providing access to data supporting the Resource Conservation and Recovery Act (RCRA) of 1976 and the Hazardous and Solid Waste Amendments (HSWA) of 1984. The database includes selective information on sites which generate, transport, store, treat and/or dispose of hazardous waste as defined by the Resource Conservation and Recovery Act (RCRA). Small quantity generators (SQGs) generate between 100 kg and 1,000 kg of hazardous waste per month.

Date of Government Version: 03/22/2021	Source: Environmental Protection Agency
Date Data Arrived at EDR: 03/23/2021	Telephone: (415) 495-8895
Date Made Active in Reports: 05/19/2021	Last EDR Contact: 03/23/2021
Number of Days to Update: 57	Next Scheduled EDR Contact: 07/05/2021
	Data Release Frequency: Quarterly

RCRA-VSQG: RCRA - Very Small Quantity Generators (Formerly Conditionally Exempt Small Quantity Generators)

RCRAInfo is EPA's comprehensive information system, providing access to data supporting the Resource Conservation and Recovery Act (RCRA) of 1976 and the Hazardous and Solid Waste Amendments (HSWA) of 1984. The database includes selective information on sites which generate, transport, store, treat and/or dispose of hazardous waste as defined by the Resource Conservation and Recovery Act (RCRA). Very small quantity generators (VSQGs) generate less than 100 kg of hazardous waste, or less than 1 kg of acutely hazardous waste per month.

Date of Government Version: 03/22/2021	Source: Environmental Protection Agency
Date Data Arrived at EDR: 03/23/2021	Telephone: (415) 495-8895
Date Made Active in Reports: 05/19/2021	Last EDR Contact: 03/23/2021
Number of Days to Update: 57	Next Scheduled EDR Contact: 07/05/2021
	Data Release Frequency: Quarterly

Federal institutional controls / engineering controls registries

LUCIS: Land Use Control Information System

LUCIS contains records of land use control information pertaining to the former Navy Base Realignment and Closure properties.

Date of Government Version: 02/09/2021	Source: Department of the Navy
Date Data Arrived at EDR: 02/11/2021	Telephone: 843-820-7326
Date Made Active in Reports: 03/22/2021	Last EDR Contact: 05/05/2021
Number of Days to Update: 39	Next Scheduled EDR Contact: 08/23/2021
	Data Release Frequency: Varies

US ENG CONTROLS: Engineering Controls Sites List

A listing of sites with engineering controls in place. Engineering controls include various forms of caps, building foundations, liners, and treatment methods to create pathway elimination for regulated substances to enter environmental media or effect human health.

Date of Government Version: 02/22/2021	Source: Environmental Protection Agency
Date Data Arrived at EDR: 02/23/2021	Telephone: 703-603-0695
Date Made Active in Reports: 05/19/2021	Last EDR Contact: 05/21/2021
Number of Days to Update: 85	Next Scheduled EDR Contact: 09/06/2021
	Data Release Frequency: Varies

US INST CONTROLS: Institutional Controls Sites List

A listing of sites with institutional controls in place. Institutional controls include administrative measures, such as groundwater use restrictions, construction restrictions, property use restrictions, and post remediation care requirements intended to prevent exposure to contaminants remaining on site. Deed restrictions are generally required as part of the institutional controls.

Date of Government Version: 02/22/2021	Source: Environmental Protection Agency
Date Data Arrived at EDR: 02/23/2021	Telephone: 703-603-0695
Date Made Active in Reports: 05/19/2021	Last EDR Contact: 05/21/2021
Number of Days to Update: 85	Next Scheduled EDR Contact: 09/06/2021
	Data Release Frequency: Varies

GOVERNMENT RECORDS SEARCHED / DATA CURRENCY TRACKING

Federal ERNS list

ERNS: Emergency Response Notification System

Emergency Response Notification System. ERNS records and stores information on reported releases of oil and hazardous substances.

Date of Government Version: 12/14/2020
Date Data Arrived at EDR: 12/15/2020
Date Made Active in Reports: 12/22/2020
Number of Days to Update: 7

Source: National Response Center, United States Coast Guard
Telephone: 202-267-2180
Last EDR Contact: 12/15/2020
Next Scheduled EDR Contact: 07/05/2021
Data Release Frequency: Quarterly

State- and tribal - equivalent NPL

RESPONSE: State Response Sites

Identifies confirmed release sites where DTSC is involved in remediation, either in a lead or oversight capacity. These confirmed release sites are generally high-priority and high potential risk.

Date of Government Version: 01/25/2021
Date Data Arrived at EDR: 01/26/2021
Date Made Active in Reports: 04/13/2021
Number of Days to Update: 77

Source: Department of Toxic Substances Control
Telephone: 916-323-3400
Last EDR Contact: 04/23/2021
Next Scheduled EDR Contact: 08/09/2021
Data Release Frequency: Quarterly

State- and tribal - equivalent CERCLIS

ENVIROSTOR: EnviroStor Database

The Department of Toxic Substances Control's (DTSC's) Site Mitigation and Brownfields Reuse Program's (SMBRP's) EnviroStor database identifies sites that have known contamination or sites for which there may be reasons to investigate further. The database includes the following site types: Federal Superfund sites (National Priorities List (NPL)); State Response, including Military Facilities and State Superfund; Voluntary Cleanup; and School sites. EnviroStor provides similar information to the information that was available in CalSites, and provides additional site information, including, but not limited to, identification of formerly-contaminated properties that have been released for reuse, properties where environmental deed restrictions have been recorded to prevent inappropriate land uses, and risk characterization information that is used to assess potential impacts to public health and the environment at contaminated sites.

Date of Government Version: 01/25/2021
Date Data Arrived at EDR: 01/26/2021
Date Made Active in Reports: 04/13/2021
Number of Days to Update: 77

Source: Department of Toxic Substances Control
Telephone: 916-323-3400
Last EDR Contact: 04/23/2021
Next Scheduled EDR Contact: 08/09/2021
Data Release Frequency: Quarterly

State and tribal landfill and/or solid waste disposal site lists

SWF/LF (SWIS): Solid Waste Information System

Active, Closed and Inactive Landfills. SWF/LF records typically contain an inventory of solid waste disposal facilities or landfills. These may be active or inactive facilities or open dumps that failed to meet RCRA Section 4004 criteria for solid waste landfills or disposal sites.

Date of Government Version: 02/08/2021
Date Data Arrived at EDR: 02/09/2021
Date Made Active in Reports: 05/03/2021
Number of Days to Update: 83

Source: Department of Resources Recycling and Recovery
Telephone: 916-341-6320
Last EDR Contact: 05/11/2021
Next Scheduled EDR Contact: 08/23/2021
Data Release Frequency: Quarterly

State and tribal leaking storage tank lists

GOVERNMENT RECORDS SEARCHED / DATA CURRENCY TRACKING

LUST: Leaking Underground Fuel Tank Report (GEOTRACKER)

Leaking Underground Storage Tank (LUST) Sites included in GeoTracker. GeoTracker is the Water Boards data management system for sites that impact, or have the potential to impact, water quality in California, with emphasis on groundwater.

Date of Government Version: 03/08/2021	Source: State Water Resources Control Board
Date Data Arrived at EDR: 03/09/2021	Telephone: see region list
Date Made Active in Reports: 03/30/2021	Last EDR Contact: 06/03/2021
Number of Days to Update: 21	Next Scheduled EDR Contact: 09/20/2021
	Data Release Frequency: Quarterly

LUST REG 4: Underground Storage Tank Leak List

Los Angeles, Ventura counties. For more current information, please refer to the State Water Resources Control Board's LUST database.

Date of Government Version: 09/07/2004	Source: California Regional Water Quality Control Board Los Angeles Region (4)
Date Data Arrived at EDR: 09/07/2004	Telephone: 213-576-6710
Date Made Active in Reports: 10/12/2004	Last EDR Contact: 09/06/2011
Number of Days to Update: 35	Next Scheduled EDR Contact: 12/19/2011
	Data Release Frequency: No Update Planned

LUST REG 3: Leaking Underground Storage Tank Database

Leaking Underground Storage Tank locations. Monterey, San Benito, San Luis Obispo, Santa Barbara, Santa Cruz counties.

Date of Government Version: 05/19/2003	Source: California Regional Water Quality Control Board Central Coast Region (3)
Date Data Arrived at EDR: 05/19/2003	Telephone: 805-542-4786
Date Made Active in Reports: 06/02/2003	Last EDR Contact: 07/18/2011
Number of Days to Update: 14	Next Scheduled EDR Contact: 10/31/2011
	Data Release Frequency: No Update Planned

LUST REG 2: Fuel Leak List

Leaking Underground Storage Tank locations. Alameda, Contra Costa, Marin, Napa, San Francisco, San Mateo, Santa Clara, Solano, Sonoma counties.

Date of Government Version: 09/30/2004	Source: California Regional Water Quality Control Board San Francisco Bay Region (2)
Date Data Arrived at EDR: 10/20/2004	Telephone: 510-622-2433
Date Made Active in Reports: 11/19/2004	Last EDR Contact: 09/19/2011
Number of Days to Update: 30	Next Scheduled EDR Contact: 01/02/2012
	Data Release Frequency: No Update Planned

LUST REG 1: Active Toxic Site Investigation

Del Norte, Humboldt, Lake, Mendocino, Modoc, Siskiyou, Sonoma, Trinity counties. For more current information, please refer to the State Water Resources Control Board's LUST database.

Date of Government Version: 02/01/2001	Source: California Regional Water Quality Control Board North Coast (1)
Date Data Arrived at EDR: 02/28/2001	Telephone: 707-570-3769
Date Made Active in Reports: 03/29/2001	Last EDR Contact: 08/01/2011
Number of Days to Update: 29	Next Scheduled EDR Contact: 11/14/2011
	Data Release Frequency: No Update Planned

LUST REG 6V: Leaking Underground Storage Tank Case Listing

Leaking Underground Storage Tank locations. Inyo, Kern, Los Angeles, Mono, San Bernardino counties.

Date of Government Version: 06/07/2005	Source: California Regional Water Quality Control Board Victorville Branch Office (6)
Date Data Arrived at EDR: 06/07/2005	Telephone: 760-241-7365
Date Made Active in Reports: 06/29/2005	Last EDR Contact: 09/12/2011
Number of Days to Update: 22	Next Scheduled EDR Contact: 12/26/2011
	Data Release Frequency: No Update Planned

LUST REG 6L: Leaking Underground Storage Tank Case Listing

For more current information, please refer to the State Water Resources Control Board's LUST database.

GOVERNMENT RECORDS SEARCHED / DATA CURRENCY TRACKING

Date of Government Version: 09/09/2003
Date Data Arrived at EDR: 09/10/2003
Date Made Active in Reports: 10/07/2003
Number of Days to Update: 27

Source: California Regional Water Quality Control Board Lahontan Region (6)
Telephone: 530-542-5572
Last EDR Contact: 09/12/2011
Next Scheduled EDR Contact: 12/26/2011
Data Release Frequency: No Update Planned

LUST REG 7: Leaking Underground Storage Tank Case Listing

Leaking Underground Storage Tank locations. Imperial, Riverside, San Diego, Santa Barbara counties.

Date of Government Version: 02/26/2004
Date Data Arrived at EDR: 02/26/2004
Date Made Active in Reports: 03/24/2004
Number of Days to Update: 27

Source: California Regional Water Quality Control Board Colorado River Basin Region (7)
Telephone: 760-776-8943
Last EDR Contact: 08/01/2011
Next Scheduled EDR Contact: 11/14/2011
Data Release Frequency: No Update Planned

LUST REG 8: Leaking Underground Storage Tanks

California Regional Water Quality Control Board Santa Ana Region (8). For more current information, please refer to the State Water Resources Control Board's LUST database.

Date of Government Version: 02/14/2005
Date Data Arrived at EDR: 02/15/2005
Date Made Active in Reports: 03/28/2005
Number of Days to Update: 41

Source: California Regional Water Quality Control Board Santa Ana Region (8)
Telephone: 909-782-4496
Last EDR Contact: 08/15/2011
Next Scheduled EDR Contact: 11/28/2011
Data Release Frequency: No Update Planned

LUST REG 9: Leaking Underground Storage Tank Report

Orange, Riverside, San Diego counties. For more current information, please refer to the State Water Resources Control Board's LUST database.

Date of Government Version: 03/01/2001
Date Data Arrived at EDR: 04/23/2001
Date Made Active in Reports: 05/21/2001
Number of Days to Update: 28

Source: California Regional Water Quality Control Board San Diego Region (9)
Telephone: 858-637-5595
Last EDR Contact: 09/26/2011
Next Scheduled EDR Contact: 01/09/2012
Data Release Frequency: No Update Planned

LUST REG 5: Leaking Underground Storage Tank Database

Leaking Underground Storage Tank locations. Alameda, Alpine, Amador, Butte, Colusa, Contra Costa, Calveras, El Dorado, Fresno, Glenn, Kern, Kings, Lake, Lassen, Madera, Mariposa, Merced, Modoc, Napa, Nevada, Placer, Plumas, Sacramento, San Joaquin, Shasta, Solano, Stanislaus, Sutter, Tehama, Tulare, Tuolumne, Yolo, Yuba counties.

Date of Government Version: 07/01/2008
Date Data Arrived at EDR: 07/22/2008
Date Made Active in Reports: 07/31/2008
Number of Days to Update: 9

Source: California Regional Water Quality Control Board Central Valley Region (5)
Telephone: 916-464-4834
Last EDR Contact: 07/01/2011
Next Scheduled EDR Contact: 10/17/2011
Data Release Frequency: No Update Planned

INDIAN LUST R10: Leaking Underground Storage Tanks on Indian Land

LUSTs on Indian land in Alaska, Idaho, Oregon and Washington.

Date of Government Version: 11/12/2020
Date Data Arrived at EDR: 12/16/2020
Date Made Active in Reports: 03/12/2021
Number of Days to Update: 86

Source: EPA Region 10
Telephone: 206-553-2857
Last EDR Contact: 04/23/2021
Next Scheduled EDR Contact: 08/02/2021
Data Release Frequency: Varies

INDIAN LUST R5: Leaking Underground Storage Tanks on Indian Land

Leaking underground storage tanks located on Indian Land in Michigan, Minnesota and Wisconsin.

Date of Government Version: 10/07/2020
Date Data Arrived at EDR: 12/16/2020
Date Made Active in Reports: 03/12/2021
Number of Days to Update: 86

Source: EPA, Region 5
Telephone: 312-886-7439
Last EDR Contact: 04/23/2021
Next Scheduled EDR Contact: 08/02/2021
Data Release Frequency: Varies

GOVERNMENT RECORDS SEARCHED / DATA CURRENCY TRACKING

INDIAN LUST R9: Leaking Underground Storage Tanks on Indian Land
LUSTs on Indian land in Arizona, California, New Mexico and Nevada

Date of Government Version: 10/01/2020	Source: Environmental Protection Agency
Date Data Arrived at EDR: 12/16/2020	Telephone: 415-972-3372
Date Made Active in Reports: 03/12/2021	Last EDR Contact: 04/23/2021
Number of Days to Update: 86	Next Scheduled EDR Contact: 08/02/2021
	Data Release Frequency: Varies

INDIAN LUST R8: Leaking Underground Storage Tanks on Indian Land
LUSTs on Indian land in Colorado, Montana, North Dakota, South Dakota, Utah and Wyoming.

Date of Government Version: 10/09/2020	Source: EPA Region 8
Date Data Arrived at EDR: 12/16/2020	Telephone: 303-312-6271
Date Made Active in Reports: 03/12/2021	Last EDR Contact: 04/23/2021
Number of Days to Update: 86	Next Scheduled EDR Contact: 08/02/2021
	Data Release Frequency: Varies

INDIAN LUST R7: Leaking Underground Storage Tanks on Indian Land
LUSTs on Indian land in Iowa, Kansas, and Nebraska

Date of Government Version: 09/30/2020	Source: EPA Region 7
Date Data Arrived at EDR: 12/22/2020	Telephone: 913-551-7003
Date Made Active in Reports: 03/12/2021	Last EDR Contact: 04/23/2021
Number of Days to Update: 80	Next Scheduled EDR Contact: 08/02/2021
	Data Release Frequency: Varies

INDIAN LUST R4: Leaking Underground Storage Tanks on Indian Land
LUSTs on Indian land in Florida, Mississippi and North Carolina.

Date of Government Version: 10/02/2020	Source: EPA Region 4
Date Data Arrived at EDR: 12/18/2020	Telephone: 404-562-8677
Date Made Active in Reports: 03/12/2021	Last EDR Contact: 04/23/2021
Number of Days to Update: 84	Next Scheduled EDR Contact: 08/02/2021
	Data Release Frequency: Varies

INDIAN LUST R1: Leaking Underground Storage Tanks on Indian Land
A listing of leaking underground storage tank locations on Indian Land.

Date of Government Version: 10/01/2020	Source: EPA Region 1
Date Data Arrived at EDR: 12/16/2020	Telephone: 617-918-1313
Date Made Active in Reports: 03/12/2021	Last EDR Contact: 04/23/2021
Number of Days to Update: 86	Next Scheduled EDR Contact: 08/02/2021
	Data Release Frequency: Varies

INDIAN LUST R6: Leaking Underground Storage Tanks on Indian Land
LUSTs on Indian land in New Mexico and Oklahoma.

Date of Government Version: 04/08/2020	Source: EPA Region 6
Date Data Arrived at EDR: 05/20/2020	Telephone: 214-665-6597
Date Made Active in Reports: 08/12/2020	Last EDR Contact: 04/23/2021
Number of Days to Update: 84	Next Scheduled EDR Contact: 08/02/2021
	Data Release Frequency: Varies

CPS-SLIC: Statewide SLIC Cases (GEOTRACKER)

Cleanup Program Sites (CPS; also known as Site Cleanups [SC] and formerly known as Spills, Leaks, Investigations, and Cleanups [SLIC] sites) included in GeoTracker. GeoTracker is the Water Boards data management system for sites that impact, or have the potential to impact, water quality in California, with emphasis on groundwater.

Date of Government Version: 03/08/2021	Source: State Water Resources Control Board
Date Data Arrived at EDR: 03/09/2021	Telephone: 866-480-1028
Date Made Active in Reports: 03/30/2021	Last EDR Contact: 06/03/2021
Number of Days to Update: 21	Next Scheduled EDR Contact: 09/20/2021
	Data Release Frequency: Varies

GOVERNMENT RECORDS SEARCHED / DATA CURRENCY TRACKING

SLIC REG 1: Active Toxic Site Investigations

The SLIC (Spills, Leaks, Investigations and Cleanup) program is designed to protect and restore water quality from spills, leaks, and similar discharges.

Date of Government Version: 04/03/2003
Date Data Arrived at EDR: 04/07/2003
Date Made Active in Reports: 04/25/2003
Number of Days to Update: 18

Source: California Regional Water Quality Control Board, North Coast Region (1)
Telephone: 707-576-2220
Last EDR Contact: 08/01/2011
Next Scheduled EDR Contact: 11/14/2011
Data Release Frequency: No Update Planned

SLIC REG 2: Spills, Leaks, Investigation & Cleanup Cost Recovery Listing

The SLIC (Spills, Leaks, Investigations and Cleanup) program is designed to protect and restore water quality from spills, leaks, and similar discharges.

Date of Government Version: 09/30/2004
Date Data Arrived at EDR: 10/20/2004
Date Made Active in Reports: 11/19/2004
Number of Days to Update: 30

Source: Regional Water Quality Control Board San Francisco Bay Region (2)
Telephone: 510-286-0457
Last EDR Contact: 09/19/2011
Next Scheduled EDR Contact: 01/02/2012
Data Release Frequency: No Update Planned

SLIC REG 3: Spills, Leaks, Investigation & Cleanup Cost Recovery Listing

The SLIC (Spills, Leaks, Investigations and Cleanup) program is designed to protect and restore water quality from spills, leaks, and similar discharges.

Date of Government Version: 05/18/2006
Date Data Arrived at EDR: 05/18/2006
Date Made Active in Reports: 06/15/2006
Number of Days to Update: 28

Source: California Regional Water Quality Control Board Central Coast Region (3)
Telephone: 805-549-3147
Last EDR Contact: 07/18/2011
Next Scheduled EDR Contact: 10/31/2011
Data Release Frequency: No Update Planned

SLIC REG 4: Spills, Leaks, Investigation & Cleanup Cost Recovery Listing

The SLIC (Spills, Leaks, Investigations and Cleanup) program is designed to protect and restore water quality from spills, leaks, and similar discharges.

Date of Government Version: 11/17/2004
Date Data Arrived at EDR: 11/18/2004
Date Made Active in Reports: 01/04/2005
Number of Days to Update: 47

Source: Region Water Quality Control Board Los Angeles Region (4)
Telephone: 213-576-6600
Last EDR Contact: 07/01/2011
Next Scheduled EDR Contact: 10/17/2011
Data Release Frequency: No Update Planned

SLIC REG 5: Spills, Leaks, Investigation & Cleanup Cost Recovery Listing

The SLIC (Spills, Leaks, Investigations and Cleanup) program is designed to protect and restore water quality from spills, leaks, and similar discharges.

Date of Government Version: 04/01/2005
Date Data Arrived at EDR: 04/05/2005
Date Made Active in Reports: 04/21/2005
Number of Days to Update: 16

Source: Regional Water Quality Control Board Central Valley Region (5)
Telephone: 916-464-3291
Last EDR Contact: 09/12/2011
Next Scheduled EDR Contact: 12/26/2011
Data Release Frequency: No Update Planned

SLIC REG 6V: Spills, Leaks, Investigation & Cleanup Cost Recovery Listing

The SLIC (Spills, Leaks, Investigations and Cleanup) program is designed to protect and restore water quality from spills, leaks, and similar discharges.

Date of Government Version: 05/24/2005
Date Data Arrived at EDR: 05/25/2005
Date Made Active in Reports: 06/16/2005
Number of Days to Update: 22

Source: Regional Water Quality Control Board, Victorville Branch
Telephone: 619-241-6583
Last EDR Contact: 08/15/2011
Next Scheduled EDR Contact: 11/28/2011
Data Release Frequency: No Update Planned

GOVERNMENT RECORDS SEARCHED / DATA CURRENCY TRACKING

SLIC REG 6L: SLIC Sites

The SLIC (Spills, Leaks, Investigations and Cleanup) program is designed to protect and restore water quality from spills, leaks, and similar discharges.

Date of Government Version: 09/07/2004
Date Data Arrived at EDR: 09/07/2004
Date Made Active in Reports: 10/12/2004
Number of Days to Update: 35

Source: California Regional Water Quality Control Board, Lahontan Region
Telephone: 530-542-5574
Last EDR Contact: 08/15/2011
Next Scheduled EDR Contact: 11/28/2011
Data Release Frequency: No Update Planned

SLIC REG 7: SLIC List

The SLIC (Spills, Leaks, Investigations and Cleanup) program is designed to protect and restore water quality from spills, leaks, and similar discharges.

Date of Government Version: 11/24/2004
Date Data Arrived at EDR: 11/29/2004
Date Made Active in Reports: 01/04/2005
Number of Days to Update: 36

Source: California Regional Quality Control Board, Colorado River Basin Region
Telephone: 760-346-7491
Last EDR Contact: 08/01/2011
Next Scheduled EDR Contact: 11/14/2011
Data Release Frequency: No Update Planned

SLIC REG 8: Spills, Leaks, Investigation & Cleanup Cost Recovery Listing

The SLIC (Spills, Leaks, Investigations and Cleanup) program is designed to protect and restore water quality from spills, leaks, and similar discharges.

Date of Government Version: 04/03/2008
Date Data Arrived at EDR: 04/03/2008
Date Made Active in Reports: 04/14/2008
Number of Days to Update: 11

Source: California Region Water Quality Control Board Santa Ana Region (8)
Telephone: 951-782-3298
Last EDR Contact: 09/12/2011
Next Scheduled EDR Contact: 12/26/2011
Data Release Frequency: No Update Planned

SLIC REG 9: Spills, Leaks, Investigation & Cleanup Cost Recovery Listing

The SLIC (Spills, Leaks, Investigations and Cleanup) program is designed to protect and restore water quality from spills, leaks, and similar discharges.

Date of Government Version: 09/10/2007
Date Data Arrived at EDR: 09/11/2007
Date Made Active in Reports: 09/28/2007
Number of Days to Update: 17

Source: California Regional Water Quality Control Board San Diego Region (9)
Telephone: 858-467-2980
Last EDR Contact: 08/08/2011
Next Scheduled EDR Contact: 11/21/2011
Data Release Frequency: No Update Planned

State and tribal registered storage tank lists

FEMA UST: Underground Storage Tank Listing

A listing of all FEMA owned underground storage tanks.

Date of Government Version: 01/29/2021
Date Data Arrived at EDR: 02/17/2021
Date Made Active in Reports: 03/22/2021
Number of Days to Update: 33

Source: FEMA
Telephone: 202-646-5797
Last EDR Contact: 04/05/2021
Next Scheduled EDR Contact: 07/19/2021
Data Release Frequency: Varies

UST CLOSURE: Proposed Closure of Underground Storage Tank (UST) Cases

UST cases that are being considered for closure by either the State Water Resources Control Board or the Executive Director have been posted for a 60-day public comment period. UST Case Closures being proposed for consideration by the State Water Resources Control Board. These are primarily UST cases that meet closure criteria under the decisional framework in State Water Board Resolution No. 92-49 and other Board orders. UST Case Closures proposed for consideration by the Executive Director pursuant to State Water Board Resolution No. 2012-0061. These are cases that meet the criteria of the Low-Threat UST Case Closure Policy. UST Case Closure Review Denials and Approved Orders.

GOVERNMENT RECORDS SEARCHED / DATA CURRENCY TRACKING

Date of Government Version: 03/05/2021
Date Data Arrived at EDR: 03/09/2021
Date Made Active in Reports: 04/01/2021
Number of Days to Update: 23

Source: State Water Resources Control Board
Telephone: 916-327-7844
Last EDR Contact: 06/04/2021
Next Scheduled EDR Contact: 09/20/2021
Data Release Frequency: Varies

MILITARY UST SITES: Military UST Sites (GEOTRACKER)

Military ust sites

Date of Government Version: 03/08/2021
Date Data Arrived at EDR: 03/09/2021
Date Made Active in Reports: 03/30/2021
Number of Days to Update: 21

Source: State Water Resources Control Board
Telephone: 866-480-1028
Last EDR Contact: 06/03/2021
Next Scheduled EDR Contact: 09/20/2021
Data Release Frequency: Varies

UST: Active UST Facilities

Active UST facilities gathered from the local regulatory agencies

Date of Government Version: 03/08/2021
Date Data Arrived at EDR: 03/09/2021
Date Made Active in Reports: 03/31/2021
Number of Days to Update: 22

Source: SWRCB
Telephone: 916-341-5851
Last EDR Contact: 06/03/2021
Next Scheduled EDR Contact: 09/20/2021
Data Release Frequency: Semi-Annually

AST: Aboveground Petroleum Storage Tank Facilities

A listing of aboveground storage tank petroleum storage tank locations.

Date of Government Version: 07/06/2016
Date Data Arrived at EDR: 07/12/2016
Date Made Active in Reports: 09/19/2016
Number of Days to Update: 69

Source: California Environmental Protection Agency
Telephone: 916-327-5092
Last EDR Contact: 06/08/2021
Next Scheduled EDR Contact: 09/27/2021
Data Release Frequency: Varies

INDIAN UST R1: Underground Storage Tanks on Indian Land

The Indian Underground Storage Tank (UST) database provides information about underground storage tanks on Indian land in EPA Region 1 (Connecticut, Maine, Massachusetts, New Hampshire, Rhode Island, Vermont and ten Tribal Nations).

Date of Government Version: 10/01/2020
Date Data Arrived at EDR: 12/16/2020
Date Made Active in Reports: 03/12/2021
Number of Days to Update: 86

Source: EPA, Region 1
Telephone: 617-918-1313
Last EDR Contact: 04/23/2021
Next Scheduled EDR Contact: 08/02/2021
Data Release Frequency: Varies

INDIAN UST R4: Underground Storage Tanks on Indian Land

The Indian Underground Storage Tank (UST) database provides information about underground storage tanks on Indian land in EPA Region 4 (Alabama, Florida, Georgia, Kentucky, Mississippi, North Carolina, South Carolina, Tennessee and Tribal Nations)

Date of Government Version: 10/02/2020
Date Data Arrived at EDR: 12/18/2020
Date Made Active in Reports: 03/12/2021
Number of Days to Update: 84

Source: EPA Region 4
Telephone: 404-562-9424
Last EDR Contact: 04/23/2021
Next Scheduled EDR Contact: 08/02/2021
Data Release Frequency: Varies

INDIAN UST R10: Underground Storage Tanks on Indian Land

The Indian Underground Storage Tank (UST) database provides information about underground storage tanks on Indian land in EPA Region 10 (Alaska, Idaho, Oregon, Washington, and Tribal Nations).

GOVERNMENT RECORDS SEARCHED / DATA CURRENCY TRACKING

Date of Government Version: 11/12/2020
Date Data Arrived at EDR: 12/16/2020
Date Made Active in Reports: 03/12/2021
Number of Days to Update: 86

Source: EPA Region 10
Telephone: 206-553-2857
Last EDR Contact: 04/23/2021
Next Scheduled EDR Contact: 08/02/2021
Data Release Frequency: Varies

INDIAN UST R6: Underground Storage Tanks on Indian Land

The Indian Underground Storage Tank (UST) database provides information about underground storage tanks on Indian land in EPA Region 6 (Louisiana, Arkansas, Oklahoma, New Mexico, Texas and 65 Tribes).

Date of Government Version: 04/08/2020
Date Data Arrived at EDR: 05/20/2020
Date Made Active in Reports: 08/12/2020
Number of Days to Update: 84

Source: EPA Region 6
Telephone: 214-665-7591
Last EDR Contact: 04/23/2021
Next Scheduled EDR Contact: 08/02/2021
Data Release Frequency: Varies

INDIAN UST R8: Underground Storage Tanks on Indian Land

The Indian Underground Storage Tank (UST) database provides information about underground storage tanks on Indian land in EPA Region 8 (Colorado, Montana, North Dakota, South Dakota, Utah, Wyoming and 27 Tribal Nations).

Date of Government Version: 10/09/2020
Date Data Arrived at EDR: 12/16/2020
Date Made Active in Reports: 03/12/2021
Number of Days to Update: 86

Source: EPA Region 8
Telephone: 303-312-6137
Last EDR Contact: 04/23/2021
Next Scheduled EDR Contact: 08/02/2021
Data Release Frequency: Varies

INDIAN UST R9: Underground Storage Tanks on Indian Land

The Indian Underground Storage Tank (UST) database provides information about underground storage tanks on Indian land in EPA Region 9 (Arizona, California, Hawaii, Nevada, the Pacific Islands, and Tribal Nations).

Date of Government Version: 10/01/2020
Date Data Arrived at EDR: 12/16/2020
Date Made Active in Reports: 03/12/2021
Number of Days to Update: 86

Source: EPA Region 9
Telephone: 415-972-3368
Last EDR Contact: 04/23/2021
Next Scheduled EDR Contact: 08/02/2021
Data Release Frequency: Varies

INDIAN UST R7: Underground Storage Tanks on Indian Land

The Indian Underground Storage Tank (UST) database provides information about underground storage tanks on Indian land in EPA Region 7 (Iowa, Kansas, Missouri, Nebraska, and 9 Tribal Nations).

Date of Government Version: 09/30/2020
Date Data Arrived at EDR: 12/22/2020
Date Made Active in Reports: 03/12/2021
Number of Days to Update: 80

Source: EPA Region 7
Telephone: 913-551-7003
Last EDR Contact: 04/23/2021
Next Scheduled EDR Contact: 08/02/2021
Data Release Frequency: Varies

INDIAN UST R5: Underground Storage Tanks on Indian Land

The Indian Underground Storage Tank (UST) database provides information about underground storage tanks on Indian land in EPA Region 5 (Michigan, Minnesota and Wisconsin and Tribal Nations).

Date of Government Version: 10/07/2020
Date Data Arrived at EDR: 12/16/2020
Date Made Active in Reports: 03/12/2021
Number of Days to Update: 86

Source: EPA Region 5
Telephone: 312-886-6136
Last EDR Contact: 04/23/2021
Next Scheduled EDR Contact: 08/02/2021
Data Release Frequency: Varies

State and tribal voluntary cleanup sites

INDIAN VCP R1: Voluntary Cleanup Priority Listing

A listing of voluntary cleanup priority sites located on Indian Land located in Region 1.

GOVERNMENT RECORDS SEARCHED / DATA CURRENCY TRACKING

Date of Government Version: 07/27/2015
Date Data Arrived at EDR: 09/29/2015
Date Made Active in Reports: 02/18/2016
Number of Days to Update: 142

Source: EPA, Region 1
Telephone: 617-918-1102
Last EDR Contact: 03/22/2021
Next Scheduled EDR Contact: 07/05/2021
Data Release Frequency: Varies

INDIAN VCP R7: Voluntary Cleanup Priority Listing

A listing of voluntary cleanup priority sites located on Indian Land located in Region 7.

Date of Government Version: 03/20/2008
Date Data Arrived at EDR: 04/22/2008
Date Made Active in Reports: 05/19/2008
Number of Days to Update: 27

Source: EPA, Region 7
Telephone: 913-551-7365
Last EDR Contact: 04/20/2009
Next Scheduled EDR Contact: 07/20/2009
Data Release Frequency: Varies

VCP: Voluntary Cleanup Program Properties

Contains low threat level properties with either confirmed or unconfirmed releases and the project proponents have request that DTSC oversee investigation and/or cleanup activities and have agreed to provide coverage for DTSC's costs.

Date of Government Version: 01/25/2021
Date Data Arrived at EDR: 01/26/2021
Date Made Active in Reports: 04/13/2021
Number of Days to Update: 77

Source: Department of Toxic Substances Control
Telephone: 916-323-3400
Last EDR Contact: 04/23/2021
Next Scheduled EDR Contact: 08/09/2021
Data Release Frequency: Quarterly

State and tribal Brownfields sites

BROWNFIELDS: Considered Brownfields Sites Listing

A listing of sites the SWRCB considers to be Brownfields since these are sites have come to them through the MOA Process.

Date of Government Version: 12/17/2020
Date Data Arrived at EDR: 12/17/2020
Date Made Active in Reports: 03/09/2021
Number of Days to Update: 82

Source: State Water Resources Control Board
Telephone: 916-323-7905
Last EDR Contact: 03/23/2021
Next Scheduled EDR Contact: 07/05/2021
Data Release Frequency: Quarterly

ADDITIONAL ENVIRONMENTAL RECORDS

Local Brownfield lists

US BROWNFIELDS: A Listing of Brownfields Sites

Brownfields are real property, the expansion, redevelopment, or reuse of which may be complicated by the presence or potential presence of a hazardous substance, pollutant, or contaminant. Cleaning up and reinvesting in these properties takes development pressures off of undeveloped, open land, and both improves and protects the environment. Assessment, Cleanup and Redevelopment Exchange System (ACRES) stores information reported by EPA Brownfields grant recipients on brownfields properties assessed or cleaned up with grant funding as well as information on Targeted Brownfields Assessments performed by EPA Regions. A listing of ACRES Brownfield sites is obtained from Cleanups in My Community. Cleanups in My Community provides information on Brownfields properties for which information is reported back to EPA, as well as areas served by Brownfields grant programs.

Date of Government Version: 12/11/2020
Date Data Arrived at EDR: 12/11/2020
Date Made Active in Reports: 03/02/2021
Number of Days to Update: 81

Source: Environmental Protection Agency
Telephone: 202-566-2777
Last EDR Contact: 03/16/2021
Next Scheduled EDR Contact: 06/28/2021
Data Release Frequency: Semi-Annually

Local Lists of Landfill / Solid Waste Disposal Sites

GOVERNMENT RECORDS SEARCHED / DATA CURRENCY TRACKING

WMUDS/SWAT: Waste Management Unit Database

Waste Management Unit Database System. WMUDS is used by the State Water Resources Control Board staff and the Regional Water Quality Control Boards for program tracking and inventory of waste management units. WMUDS is composed of the following databases: Facility Information, Scheduled Inspections Information, Waste Management Unit Information, SWAT Program Information, SWAT Report Summary Information, SWAT Report Summary Data, Chapter 15 (formerly Subchapter 15) Information, Chapter 15 Monitoring Parameters, TPCA Program Information, RCRA Program Information, Closure Information, and Interested Parties Information.

Date of Government Version: 04/01/2000	Source: State Water Resources Control Board
Date Data Arrived at EDR: 04/10/2000	Telephone: 916-227-4448
Date Made Active in Reports: 05/10/2000	Last EDR Contact: 04/21/2021
Number of Days to Update: 30	Next Scheduled EDR Contact: 08/09/2021
	Data Release Frequency: No Update Planned

SWRCY: Recycler Database

A listing of recycling facilities in California.

Date of Government Version: 03/09/2021	Source: Department of Conservation
Date Data Arrived at EDR: 03/09/2021	Telephone: 916-323-3836
Date Made Active in Reports: 03/31/2021	Last EDR Contact: 06/04/2021
Number of Days to Update: 22	Next Scheduled EDR Contact: 09/20/2021
	Data Release Frequency: Quarterly

HAULERS: Registered Waste Tire Haulers Listing

A listing of registered waste tire haulers.

Date of Government Version: 11/23/2020	Source: Integrated Waste Management Board
Date Data Arrived at EDR: 11/23/2020	Telephone: 916-341-6422
Date Made Active in Reports: 02/08/2021	Last EDR Contact: 05/18/2021
Number of Days to Update: 77	Next Scheduled EDR Contact: 08/23/2021
	Data Release Frequency: Varies

INDIAN ODI: Report on the Status of Open Dumps on Indian Lands

Location of open dumps on Indian land.

Date of Government Version: 12/31/1998	Source: Environmental Protection Agency
Date Data Arrived at EDR: 12/03/2007	Telephone: 703-308-8245
Date Made Active in Reports: 01/24/2008	Last EDR Contact: 04/22/2021
Number of Days to Update: 52	Next Scheduled EDR Contact: 08/09/2021
	Data Release Frequency: Varies

ODI: Open Dump Inventory

An open dump is defined as a disposal facility that does not comply with one or more of the Part 257 or Part 258 Subtitle D Criteria.

Date of Government Version: 06/30/1985	Source: Environmental Protection Agency
Date Data Arrived at EDR: 08/09/2004	Telephone: 800-424-9346
Date Made Active in Reports: 09/17/2004	Last EDR Contact: 06/09/2004
Number of Days to Update: 39	Next Scheduled EDR Contact: N/A
	Data Release Frequency: No Update Planned

DEBRIS REGION 9: Torres Martinez Reservation Illegal Dump Site Locations

A listing of illegal dump sites location on the Torres Martinez Indian Reservation located in eastern Riverside County and northern Imperial County, California.

Date of Government Version: 01/12/2009	Source: EPA, Region 9
Date Data Arrived at EDR: 05/07/2009	Telephone: 415-947-4219
Date Made Active in Reports: 09/21/2009	Last EDR Contact: 04/14/2021
Number of Days to Update: 137	Next Scheduled EDR Contact: 08/02/2021
	Data Release Frequency: No Update Planned

GOVERNMENT RECORDS SEARCHED / DATA CURRENCY TRACKING

IHS OPEN DUMPS: Open Dumps on Indian Land

A listing of all open dumps located on Indian Land in the United States.

Date of Government Version: 04/01/2014	Source: Department of Health & Human Services, Indian Health Service
Date Data Arrived at EDR: 08/06/2014	Telephone: 301-443-1452
Date Made Active in Reports: 01/29/2015	Last EDR Contact: 04/29/2021
Number of Days to Update: 176	Next Scheduled EDR Contact: 08/09/2021
	Data Release Frequency: Varies

Local Lists of Hazardous waste / Contaminated Sites

US HIST CDL: National Clandestine Laboratory Register

A listing of clandestine drug lab locations that have been removed from the DEAs National Clandestine Laboratory Register.

Date of Government Version: 12/07/2020	Source: Drug Enforcement Administration
Date Data Arrived at EDR: 12/09/2020	Telephone: 202-307-1000
Date Made Active in Reports: 03/02/2021	Last EDR Contact: 05/22/2021
Number of Days to Update: 83	Next Scheduled EDR Contact: 09/06/2021
	Data Release Frequency: No Update Planned

HIST CAL-SITES: Calsites Database

The Calsites database contains potential or confirmed hazardous substance release properties. In 1996, California EPA reevaluated and significantly reduced the number of sites in the Calsites database. No longer updated by the state agency. It has been replaced by ENVIROSTOR.

Date of Government Version: 08/08/2005	Source: Department of Toxic Substance Control
Date Data Arrived at EDR: 08/03/2006	Telephone: 916-323-3400
Date Made Active in Reports: 08/24/2006	Last EDR Contact: 02/23/2009
Number of Days to Update: 21	Next Scheduled EDR Contact: 05/25/2009
	Data Release Frequency: No Update Planned

SCH: School Property Evaluation Program

This category contains proposed and existing school sites that are being evaluated by DTSC for possible hazardous materials contamination. In some cases, these properties may be listed in the CalSites category depending on the level of threat to public health and safety or the environment they pose.

Date of Government Version: 01/25/2021	Source: Department of Toxic Substances Control
Date Data Arrived at EDR: 01/26/2021	Telephone: 916-323-3400
Date Made Active in Reports: 04/13/2021	Last EDR Contact: 04/23/2021
Number of Days to Update: 77	Next Scheduled EDR Contact: 08/09/2021
	Data Release Frequency: Quarterly

CDL: Clandestine Drug Labs

A listing of drug lab locations. Listing of a location in this database does not indicate that any illegal drug lab materials were or were not present there, and does not constitute a determination that the location either requires or does not require additional cleanup work.

Date of Government Version: 12/31/2019	Source: Department of Toxic Substances Control
Date Data Arrived at EDR: 01/20/2021	Telephone: 916-255-6504
Date Made Active in Reports: 04/08/2021	Last EDR Contact: 04/14/2021
Number of Days to Update: 78	Next Scheduled EDR Contact: 07/19/2021
	Data Release Frequency: Varies

TOXIC PITS: Toxic Pits Cleanup Act Sites

Toxic PITS Cleanup Act Sites. TOXIC PITS identifies sites suspected of containing hazardous substances where cleanup has not yet been completed.

Date of Government Version: 07/01/1995	Source: State Water Resources Control Board
Date Data Arrived at EDR: 08/30/1995	Telephone: 916-227-4364
Date Made Active in Reports: 09/26/1995	Last EDR Contact: 01/26/2009
Number of Days to Update: 27	Next Scheduled EDR Contact: 04/27/2009
	Data Release Frequency: No Update Planned

GOVERNMENT RECORDS SEARCHED / DATA CURRENCY TRACKING

CERS HAZ WASTE: CERS HAZ WASTE

List of sites in the California Environmental Protection Agency (CalEPA) Regulated Site Portal which fall under the Hazardous Chemical Management, Hazardous Waste Onsite Treatment, Household Hazardous Waste Collection, Hazardous Waste Generator, and RCRA LQ HW Generator programs.

Date of Government Version: 01/20/2021	Source: CalEPA
Date Data Arrived at EDR: 01/20/2021	Telephone: 916-323-2514
Date Made Active in Reports: 04/08/2021	Last EDR Contact: 04/20/2021
Number of Days to Update: 78	Next Scheduled EDR Contact: 08/02/2021
	Data Release Frequency: Quarterly

US CDL: Clandestine Drug Labs

A listing of clandestine drug lab locations. The U.S. Department of Justice ("the Department") provides this web site as a public service. It contains addresses of some locations where law enforcement agencies reported they found chemicals or other items that indicated the presence of either clandestine drug laboratories or dumpsites. In most cases, the source of the entries is not the Department, and the Department has not verified the entry and does not guarantee its accuracy. Members of the public must verify the accuracy of all entries by, for example, contacting local law enforcement and local health departments.

Date of Government Version: 12/07/2020	Source: Drug Enforcement Administration
Date Data Arrived at EDR: 12/09/2020	Telephone: 202-307-1000
Date Made Active in Reports: 03/02/2021	Last EDR Contact: 05/18/2021
Number of Days to Update: 83	Next Scheduled EDR Contact: 09/06/2021
	Data Release Frequency: Quarterly

PFAS: PFAS Contamination Site Location Listing

A listing of PFAS contaminated sites included in the GeoTracker database.

Date of Government Version: 02/24/2021	Source: State Water Resources Control Board
Date Data Arrived at EDR: 02/24/2021	Telephone: 866-480-1028
Date Made Active in Reports: 05/14/2021	Last EDR Contact: 06/04/2021
Number of Days to Update: 79	Next Scheduled EDR Contact: 09/20/2021
	Data Release Frequency: Varies

Local Lists of Registered Storage Tanks

SWEEPS UST: SWEEPS UST Listing

Statewide Environmental Evaluation and Planning System. This underground storage tank listing was updated and maintained by a company contacted by the SWRCB in the early 1990's. The listing is no longer updated or maintained. The local agency is the contact for more information on a site on the SWEEPS list.

Date of Government Version: 06/01/1994	Source: State Water Resources Control Board
Date Data Arrived at EDR: 07/07/2005	Telephone: N/A
Date Made Active in Reports: 08/11/2005	Last EDR Contact: 06/03/2005
Number of Days to Update: 35	Next Scheduled EDR Contact: N/A
	Data Release Frequency: No Update Planned

HIST UST: Hazardous Substance Storage Container Database

The Hazardous Substance Storage Container Database is a historical listing of UST sites. Refer to local/county source for current data.

Date of Government Version: 10/15/1990	Source: State Water Resources Control Board
Date Data Arrived at EDR: 01/25/1991	Telephone: 916-341-5851
Date Made Active in Reports: 02/12/1991	Last EDR Contact: 07/26/2001
Number of Days to Update: 18	Next Scheduled EDR Contact: N/A
	Data Release Frequency: No Update Planned

SAN FRANCISCO AST: Aboveground Storage Tank Site Listing

Aboveground storage tank sites

GOVERNMENT RECORDS SEARCHED / DATA CURRENCY TRACKING

Date of Government Version: 02/11/2021
Date Data Arrived at EDR: 02/11/2021
Date Made Active in Reports: 05/05/2021
Number of Days to Update: 83

Source: San Francisco County Department of Public Health
Telephone: 415-252-3896
Last EDR Contact: 04/27/2021
Next Scheduled EDR Contact: 08/16/2021
Data Release Frequency: Varies

CA FID UST: Facility Inventory Database

The Facility Inventory Database (FID) contains a historical listing of active and inactive underground storage tank locations from the State Water Resource Control Board. Refer to local/county source for current data.

Date of Government Version: 10/31/1994
Date Data Arrived at EDR: 09/05/1995
Date Made Active in Reports: 09/29/1995
Number of Days to Update: 24

Source: California Environmental Protection Agency
Telephone: 916-341-5851
Last EDR Contact: 12/28/1998
Next Scheduled EDR Contact: N/A
Data Release Frequency: No Update Planned

CERS TANKS: California Environmental Reporting System (CERS) Tanks

List of sites in the California Environmental Protection Agency (CalEPA) Regulated Site Portal which fall under the Aboveground Petroleum Storage and Underground Storage Tank regulatory programs.

Date of Government Version: 01/20/2021
Date Data Arrived at EDR: 01/20/2021
Date Made Active in Reports: 04/08/2021
Number of Days to Update: 78

Source: California Environmental Protection Agency
Telephone: 916-323-2514
Last EDR Contact: 04/20/2021
Next Scheduled EDR Contact: 08/02/2021
Data Release Frequency: Quarterly

Local Land Records

LIENS: Environmental Liens Listing

A listing of property locations with environmental liens for California where DTSC is a lien holder.

Date of Government Version: 03/01/2021
Date Data Arrived at EDR: 03/03/2021
Date Made Active in Reports: 05/20/2021
Number of Days to Update: 78

Source: Department of Toxic Substances Control
Telephone: 916-323-3400
Last EDR Contact: 05/25/2021
Next Scheduled EDR Contact: 09/13/2021
Data Release Frequency: Varies

LIENS 2: CERCLA Lien Information

A Federal CERCLA ('Superfund') lien can exist by operation of law at any site or property at which EPA has spent Superfund monies. These monies are spent to investigate and address releases and threatened releases of contamination. CERCLIS provides information as to the identity of these sites and properties.

Date of Government Version: 04/27/2021
Date Data Arrived at EDR: 05/03/2021
Date Made Active in Reports: 05/19/2021
Number of Days to Update: 16

Source: Environmental Protection Agency
Telephone: 202-564-6023
Last EDR Contact: 06/04/2021
Next Scheduled EDR Contact: 07/12/2021
Data Release Frequency: Semi-Annually

DEED: Deed Restriction Listing

GOVERNMENT RECORDS SEARCHED / DATA CURRENCY TRACKING

Site Mitigation and Brownfields Reuse Program Facility Sites with Deed Restrictions & Hazardous Waste Management Program Facility Sites with Deed / Land Use Restriction. The DTSC Site Mitigation and Brownfields Reuse Program (SMBRP) list includes sites cleaned up under the program's oversight and generally does not include current or former hazardous waste facilities that required a hazardous waste facility permit. The list represents deed restrictions that are active. Some sites have multiple deed restrictions. The DTSC Hazardous Waste Management Program (HWMP) has developed a list of current or former hazardous waste facilities that have a recorded land use restriction at the local county recorder's office. The land use restrictions on this list were required by the DTSC HWMP as a result of the presence of hazardous substances that remain on site after the facility (or part of the facility) has been closed or cleaned up. The types of land use restriction include deed notice, deed restriction, or a land use restriction that binds current and future owners.

Date of Government Version: 03/02/2021	Source: DTSC and SWRCB
Date Data Arrived at EDR: 03/03/2021	Telephone: 916-323-3400
Date Made Active in Reports: 05/19/2021	Last EDR Contact: 05/28/2021
Number of Days to Update: 77	Next Scheduled EDR Contact: 09/13/2021
	Data Release Frequency: Semi-Annually

Records of Emergency Release Reports

HMIRS: Hazardous Materials Information Reporting System

Hazardous Materials Incident Report System. HMIRS contains hazardous material spill incidents reported to DOT.

Date of Government Version: 12/16/2020	Source: U.S. Department of Transportation
Date Data Arrived at EDR: 12/17/2020	Telephone: 202-366-4555
Date Made Active in Reports: 03/12/2021	Last EDR Contact: 03/24/2021
Number of Days to Update: 85	Next Scheduled EDR Contact: 07/05/2021
	Data Release Frequency: Quarterly

CHMIRS: California Hazardous Material Incident Report System

California Hazardous Material Incident Reporting System. CHMIRS contains information on reported hazardous material incidents (accidental releases or spills).

Date of Government Version: 12/31/2020	Source: Office of Emergency Services
Date Data Arrived at EDR: 01/20/2021	Telephone: 916-845-8400
Date Made Active in Reports: 04/08/2021	Last EDR Contact: 04/20/2021
Number of Days to Update: 78	Next Scheduled EDR Contact: 08/02/2021
	Data Release Frequency: Semi-Annually

LDS: Land Disposal Sites Listing (GEOTRACKER)

Land Disposal sites (Landfills) included in GeoTracker. GeoTracker is the Water Boards data management system for sites that impact, or have the potential to impact, water quality in California, with emphasis on groundwater.

Date of Government Version: 03/08/2021	Source: State Water Quality Control Board
Date Data Arrived at EDR: 03/09/2021	Telephone: 866-480-1028
Date Made Active in Reports: 03/31/2021	Last EDR Contact: 06/03/2021
Number of Days to Update: 22	Next Scheduled EDR Contact: 09/20/2021
	Data Release Frequency: Quarterly

MCS: Military Cleanup Sites Listing (GEOTRACKER)

Military sites (consisting of: Military UST sites; Military Privatized sites; and Military Cleanup sites [formerly known as DoD non UST]) included in GeoTracker. GeoTracker is the Water Boards data management system for sites that impact, or have the potential to impact, water quality in California, with emphasis on groundwater.

Date of Government Version: 03/08/2021	Source: State Water Resources Control Board
Date Data Arrived at EDR: 03/09/2021	Telephone: 866-480-1028
Date Made Active in Reports: 03/31/2021	Last EDR Contact: 06/03/2021
Number of Days to Update: 22	Next Scheduled EDR Contact: 09/20/2021
	Data Release Frequency: Quarterly

GOVERNMENT RECORDS SEARCHED / DATA CURRENCY TRACKING

SPILLS 90: SPILLS90 data from FirstSearch

Spills 90 includes those spill and release records available exclusively from FirstSearch databases. Typically, they may include chemical, oil and/or hazardous substance spills recorded after 1990. Duplicate records that are already included in EDR incident and release records are not included in Spills 90.

Date of Government Version: 06/06/2012	Source: FirstSearch
Date Data Arrived at EDR: 01/03/2013	Telephone: N/A
Date Made Active in Reports: 02/22/2013	Last EDR Contact: 01/03/2013
Number of Days to Update: 50	Next Scheduled EDR Contact: N/A
	Data Release Frequency: No Update Planned

Other Ascertainable Records

RCRA NonGen / NLR: RCRA - Non Generators / No Longer Regulated

RCRAInfo is EPA's comprehensive information system, providing access to data supporting the Resource Conservation and Recovery Act (RCRA) of 1976 and the Hazardous and Solid Waste Amendments (HSWA) of 1984. The database includes selective information on sites which generate, transport, store, treat and/or dispose of hazardous waste as defined by the Resource Conservation and Recovery Act (RCRA). Non-Generators do not presently generate hazardous waste.

Date of Government Version: 03/22/2021	Source: Environmental Protection Agency
Date Data Arrived at EDR: 03/23/2021	Telephone: (415) 495-8895
Date Made Active in Reports: 05/19/2021	Last EDR Contact: 03/23/2021
Number of Days to Update: 57	Next Scheduled EDR Contact: 07/05/2021
	Data Release Frequency: Quarterly

FUDS: Formerly Used Defense Sites

The listing includes locations of Formerly Used Defense Sites properties where the US Army Corps of Engineers is actively working or will take necessary cleanup actions.

Date of Government Version: 02/11/2021	Source: U.S. Army Corps of Engineers
Date Data Arrived at EDR: 02/17/2021	Telephone: 202-528-4285
Date Made Active in Reports: 04/05/2021	Last EDR Contact: 05/18/2021
Number of Days to Update: 47	Next Scheduled EDR Contact: 08/30/2021
	Data Release Frequency: Varies

DOD: Department of Defense Sites

This data set consists of federally owned or administered lands, administered by the Department of Defense, that have any area equal to or greater than 640 acres of the United States, Puerto Rico, and the U.S. Virgin Islands.

Date of Government Version: 12/31/2005	Source: USGS
Date Data Arrived at EDR: 11/10/2006	Telephone: 888-275-8747
Date Made Active in Reports: 01/11/2007	Last EDR Contact: 04/16/2021
Number of Days to Update: 62	Next Scheduled EDR Contact: 07/26/2021
	Data Release Frequency: Semi-Annually

FEDLAND: Federal and Indian Lands

Federally and Indian administrated lands of the United States. Lands included are administrated by: Army Corps of Engineers, Bureau of Reclamation, National Wild and Scenic River, National Wildlife Refuge, Public Domain Land, Wilderness, Wilderness Study Area, Wildlife Management Area, Bureau of Indian Affairs, Bureau of Land Management, Department of Justice, Forest Service, Fish and Wildlife Service, National Park Service.

Date of Government Version: 04/02/2018	Source: U.S. Geological Survey
Date Data Arrived at EDR: 04/11/2018	Telephone: 888-275-8747
Date Made Active in Reports: 11/06/2019	Last EDR Contact: 04/05/2021
Number of Days to Update: 574	Next Scheduled EDR Contact: 07/19/2021
	Data Release Frequency: N/A

SCRD DRYCLEANERS: State Coalition for Remediation of Drycleaners Listing

The State Coalition for Remediation of Drycleaners was established in 1998, with support from the U.S. EPA Office of Superfund Remediation and Technology Innovation. It is comprised of representatives of states with established drycleaner remediation programs. Currently the member states are Alabama, Connecticut, Florida, Illinois, Kansas, Minnesota, Missouri, North Carolina, Oregon, South Carolina, Tennessee, Texas, and Wisconsin.

GOVERNMENT RECORDS SEARCHED / DATA CURRENCY TRACKING

Date of Government Version: 01/01/2017
Date Data Arrived at EDR: 02/03/2017
Date Made Active in Reports: 04/07/2017
Number of Days to Update: 63

Source: Environmental Protection Agency
Telephone: 615-532-8599
Last EDR Contact: 05/18/2021
Next Scheduled EDR Contact: 08/23/2021
Data Release Frequency: Varies

US FIN ASSUR: Financial Assurance Information

All owners and operators of facilities that treat, store, or dispose of hazardous waste are required to provide proof that they will have sufficient funds to pay for the clean up, closure, and post-closure care of their facilities.

Date of Government Version: 12/14/2020
Date Data Arrived at EDR: 12/17/2020
Date Made Active in Reports: 03/12/2021
Number of Days to Update: 85

Source: Environmental Protection Agency
Telephone: 202-566-1917
Last EDR Contact: 03/23/2021
Next Scheduled EDR Contact: 07/05/2021
Data Release Frequency: Quarterly

EPA WATCH LIST: EPA WATCH LIST

EPA maintains a "Watch List" to facilitate dialogue between EPA, state and local environmental agencies on enforcement matters relating to facilities with alleged violations identified as either significant or high priority. Being on the Watch List does not mean that the facility has actually violated the law only that an investigation by EPA or a state or local environmental agency has led those organizations to allege that an unproven violation has in fact occurred. Being on the Watch List does not represent a higher level of concern regarding the alleged violations that were detected, but instead indicates cases requiring additional dialogue between EPA, state and local agencies - primarily because of the length of time the alleged violation has gone unaddressed or unresolved.

Date of Government Version: 08/30/2013
Date Data Arrived at EDR: 03/21/2014
Date Made Active in Reports: 06/17/2014
Number of Days to Update: 88

Source: Environmental Protection Agency
Telephone: 617-520-3000
Last EDR Contact: 04/30/2021
Next Scheduled EDR Contact: 08/16/2021
Data Release Frequency: Quarterly

2020 COR ACTION: 2020 Corrective Action Program List

The EPA has set ambitious goals for the RCRA Corrective Action program by creating the 2020 Corrective Action Universe. This RCRA cleanup baseline includes facilities expected to need corrective action. The 2020 universe contains a wide variety of sites. Some properties are heavily contaminated while others were contaminated but have since been cleaned up. Still others have not been fully investigated yet, and may require little or no remediation. Inclusion in the 2020 Universe does not necessarily imply failure on the part of a facility to meet its RCRA obligations.

Date of Government Version: 09/30/2017
Date Data Arrived at EDR: 05/08/2018
Date Made Active in Reports: 07/20/2018
Number of Days to Update: 73

Source: Environmental Protection Agency
Telephone: 703-308-4044
Last EDR Contact: 05/07/2021
Next Scheduled EDR Contact: 08/16/2021
Data Release Frequency: Varies

TSCA: Toxic Substances Control Act

Toxic Substances Control Act. TSCA identifies manufacturers and importers of chemical substances included on the TSCA Chemical Substance Inventory list. It includes data on the production volume of these substances by plant site.

Date of Government Version: 12/31/2016
Date Data Arrived at EDR: 06/17/2020
Date Made Active in Reports: 09/10/2020
Number of Days to Update: 85

Source: EPA
Telephone: 202-260-5521
Last EDR Contact: 03/19/2021
Next Scheduled EDR Contact: 06/28/2021
Data Release Frequency: Every 4 Years

TRIS: Toxic Chemical Release Inventory System

Toxic Release Inventory System. TRIS identifies facilities which release toxic chemicals to the air, water and land in reportable quantities under SARA Title III Section 313.

GOVERNMENT RECORDS SEARCHED / DATA CURRENCY TRACKING

Date of Government Version: 12/31/2018
Date Data Arrived at EDR: 08/14/2020
Date Made Active in Reports: 11/04/2020
Number of Days to Update: 82

Source: EPA
Telephone: 202-566-0250
Last EDR Contact: 05/17/2021
Next Scheduled EDR Contact: 08/30/2021
Data Release Frequency: Annually

SSTS: Section 7 Tracking Systems

Section 7 of the Federal Insecticide, Fungicide and Rodenticide Act, as amended (92 Stat. 829) requires all registered pesticide-producing establishments to submit a report to the Environmental Protection Agency by March 1st each year. Each establishment must report the types and amounts of pesticides, active ingredients and devices being produced, and those having been produced and sold or distributed in the past year.

Date of Government Version: 01/20/2021
Date Data Arrived at EDR: 01/21/2021
Date Made Active in Reports: 03/22/2021
Number of Days to Update: 60

Source: EPA
Telephone: 202-564-4203
Last EDR Contact: 04/20/2021
Next Scheduled EDR Contact: 08/02/2021
Data Release Frequency: Annually

ROD: Records Of Decision

Record of Decision. ROD documents mandate a permanent remedy at an NPL (Superfund) site containing technical and health information to aid in the cleanup.

Date of Government Version: 04/27/2021
Date Data Arrived at EDR: 05/03/2021
Date Made Active in Reports: 05/19/2021
Number of Days to Update: 16

Source: EPA
Telephone: 703-416-0223
Last EDR Contact: 06/04/2021
Next Scheduled EDR Contact: 09/13/2021
Data Release Frequency: Annually

RMP: Risk Management Plans

When Congress passed the Clean Air Act Amendments of 1990, it required EPA to publish regulations and guidance for chemical accident prevention at facilities using extremely hazardous substances. The Risk Management Program Rule (RMP Rule) was written to implement Section 112(r) of these amendments. The rule, which built upon existing industry codes and standards, requires companies of all sizes that use certain flammable and toxic substances to develop a Risk Management Program, which includes a(n): Hazard assessment that details the potential effects of an accidental release, an accident history of the last five years, and an evaluation of worst-case and alternative accidental releases; Prevention program that includes safety precautions and maintenance, monitoring, and employee training measures; and Emergency response program that spells out emergency health care, employee training measures and procedures for informing the public and response agencies (e.g the fire department) should an accident occur.

Date of Government Version: 01/22/2021
Date Data Arrived at EDR: 02/18/2021
Date Made Active in Reports: 05/11/2021
Number of Days to Update: 82

Source: Environmental Protection Agency
Telephone: 202-564-8600
Last EDR Contact: 04/19/2021
Next Scheduled EDR Contact: 08/02/2021
Data Release Frequency: Varies

RAATS: RCRA Administrative Action Tracking System

RCRA Administration Action Tracking System. RAATS contains records based on enforcement actions issued under RCRA pertaining to major violators and includes administrative and civil actions brought by the EPA. For administration actions after September 30, 1995, data entry in the RAATS database was discontinued. EPA will retain a copy of the database for historical records. It was necessary to terminate RAATS because a decrease in agency resources made it impossible to continue to update the information contained in the database.

Date of Government Version: 04/17/1995
Date Data Arrived at EDR: 07/03/1995
Date Made Active in Reports: 08/07/1995
Number of Days to Update: 35

Source: EPA
Telephone: 202-564-4104
Last EDR Contact: 06/02/2008
Next Scheduled EDR Contact: 09/01/2008
Data Release Frequency: No Update Planned

GOVERNMENT RECORDS SEARCHED / DATA CURRENCY TRACKING

PRP: Potentially Responsible Parties

A listing of verified Potentially Responsible Parties

Date of Government Version: 12/30/2020	Source: EPA
Date Data Arrived at EDR: 01/14/2021	Telephone: 202-564-6023
Date Made Active in Reports: 03/05/2021	Last EDR Contact: 06/04/2021
Number of Days to Update: 50	Next Scheduled EDR Contact: 08/16/2021
	Data Release Frequency: Quarterly

PADS: PCB Activity Database System

PCB Activity Database. PADS Identifies generators, transporters, commercial storers and/or brokers and disposers of PCB's who are required to notify the EPA of such activities.

Date of Government Version: 11/19/2020	Source: EPA
Date Data Arrived at EDR: 01/08/2021	Telephone: 202-566-0500
Date Made Active in Reports: 03/22/2021	Last EDR Contact: 04/09/2021
Number of Days to Update: 73	Next Scheduled EDR Contact: 07/19/2021
	Data Release Frequency: Annually

ICIS: Integrated Compliance Information System

The Integrated Compliance Information System (ICIS) supports the information needs of the national enforcement and compliance program as well as the unique needs of the National Pollutant Discharge Elimination System (NPDES) program.

Date of Government Version: 11/18/2016	Source: Environmental Protection Agency
Date Data Arrived at EDR: 11/23/2016	Telephone: 202-564-2501
Date Made Active in Reports: 02/10/2017	Last EDR Contact: 03/31/2021
Number of Days to Update: 79	Next Scheduled EDR Contact: 07/19/2021
	Data Release Frequency: Quarterly

FTTS: FIFRA/ TSCA Tracking System - FIFRA (Federal Insecticide, Fungicide, & Rodenticide Act)/TSCA (Toxic Substances Control Act)

FTTS tracks administrative cases and pesticide enforcement actions and compliance activities related to FIFRA, TSCA and EPCRA (Emergency Planning and Community Right-to-Know Act). To maintain currency, EDR contacts the Agency on a quarterly basis.

Date of Government Version: 04/09/2009	Source: EPA/Office of Prevention, Pesticides and Toxic Substances
Date Data Arrived at EDR: 04/16/2009	Telephone: 202-566-1667
Date Made Active in Reports: 05/11/2009	Last EDR Contact: 08/18/2017
Number of Days to Update: 25	Next Scheduled EDR Contact: 12/04/2017
	Data Release Frequency: No Update Planned

FTTS INSP: FIFRA/ TSCA Tracking System - FIFRA (Federal Insecticide, Fungicide, & Rodenticide Act)/TSCA (Toxic Substances Control Act)

A listing of FIFRA/TSCA Tracking System (FTTS) inspections and enforcements.

Date of Government Version: 04/09/2009	Source: EPA
Date Data Arrived at EDR: 04/16/2009	Telephone: 202-566-1667
Date Made Active in Reports: 05/11/2009	Last EDR Contact: 08/18/2017
Number of Days to Update: 25	Next Scheduled EDR Contact: 12/04/2017
	Data Release Frequency: No Update Planned

MLTS: Material Licensing Tracking System

MLTS is maintained by the Nuclear Regulatory Commission and contains a list of approximately 8,100 sites which possess or use radioactive materials and which are subject to NRC licensing requirements. To maintain currency, EDR contacts the Agency on a quarterly basis.

Date of Government Version: 03/08/2021	Source: Nuclear Regulatory Commission
Date Data Arrived at EDR: 03/11/2021	Telephone: 301-415-7169
Date Made Active in Reports: 05/11/2021	Last EDR Contact: 04/16/2021
Number of Days to Update: 61	Next Scheduled EDR Contact: 08/02/2021
	Data Release Frequency: Quarterly

GOVERNMENT RECORDS SEARCHED / DATA CURRENCY TRACKING

COAL ASH DOE: Steam-Electric Plant Operation Data

A listing of power plants that store ash in surface ponds.

Date of Government Version: 12/31/2019	Source: Department of Energy
Date Data Arrived at EDR: 12/01/2020	Telephone: 202-586-8719
Date Made Active in Reports: 02/09/2021	Last EDR Contact: 05/27/2021
Number of Days to Update: 70	Next Scheduled EDR Contact: 09/13/2021
	Data Release Frequency: Varies

COAL ASH EPA: Coal Combustion Residues Surface Impoundments List

A listing of coal combustion residues surface impoundments with high hazard potential ratings.

Date of Government Version: 01/12/2017	Source: Environmental Protection Agency
Date Data Arrived at EDR: 03/05/2019	Telephone: N/A
Date Made Active in Reports: 11/11/2019	Last EDR Contact: 05/27/2021
Number of Days to Update: 251	Next Scheduled EDR Contact: 09/13/2021
	Data Release Frequency: Varies

PCB TRANSFORMER: PCB Transformer Registration Database

The database of PCB transformer registrations that includes all PCB registration submittals.

Date of Government Version: 09/13/2019	Source: Environmental Protection Agency
Date Data Arrived at EDR: 11/06/2019	Telephone: 202-566-0517
Date Made Active in Reports: 02/10/2020	Last EDR Contact: 05/07/2021
Number of Days to Update: 96	Next Scheduled EDR Contact: 08/16/2021
	Data Release Frequency: Varies

RADINFO: Radiation Information Database

The Radiation Information Database (RADINFO) contains information about facilities that are regulated by U.S. Environmental Protection Agency (EPA) regulations for radiation and radioactivity.

Date of Government Version: 07/01/2019	Source: Environmental Protection Agency
Date Data Arrived at EDR: 07/01/2019	Telephone: 202-343-9775
Date Made Active in Reports: 09/23/2019	Last EDR Contact: 03/25/2021
Number of Days to Update: 84	Next Scheduled EDR Contact: 07/12/2021
	Data Release Frequency: Quarterly

HIST FTTS: FIFRA/TSCA Tracking System Administrative Case Listing

A complete administrative case listing from the FIFRA/TSCA Tracking System (FTTS) for all ten EPA regions. The information was obtained from the National Compliance Database (NCDB). NCDB supports the implementation of FIFRA (Federal Insecticide, Fungicide, and Rodenticide Act) and TSCA (Toxic Substances Control Act). Some EPA regions are now closing out records. Because of that, and the fact that some EPA regions are not providing EPA Headquarters with updated records, it was decided to create a HIST FTTS database. It included records that may not be included in the newer FTTS database updates. This database is no longer updated.

Date of Government Version: 10/19/2006	Source: Environmental Protection Agency
Date Data Arrived at EDR: 03/01/2007	Telephone: 202-564-2501
Date Made Active in Reports: 04/10/2007	Last EDR Contact: 12/17/2007
Number of Days to Update: 40	Next Scheduled EDR Contact: 03/17/2008
	Data Release Frequency: No Update Planned

HIST FTTS INSP: FIFRA/TSCA Tracking System Inspection & Enforcement Case Listing

A complete inspection and enforcement case listing from the FIFRA/TSCA Tracking System (FTTS) for all ten EPA regions. The information was obtained from the National Compliance Database (NCDB). NCDB supports the implementation of FIFRA (Federal Insecticide, Fungicide, and Rodenticide Act) and TSCA (Toxic Substances Control Act). Some EPA regions are now closing out records. Because of that, and the fact that some EPA regions are not providing EPA Headquarters with updated records, it was decided to create a HIST FTTS database. It included records that may not be included in the newer FTTS database updates. This database is no longer updated.

GOVERNMENT RECORDS SEARCHED / DATA CURRENCY TRACKING

Date of Government Version: 10/19/2006
Date Data Arrived at EDR: 03/01/2007
Date Made Active in Reports: 04/10/2007
Number of Days to Update: 40

Source: Environmental Protection Agency
Telephone: 202-564-2501
Last EDR Contact: 12/17/2008
Next Scheduled EDR Contact: 03/17/2008
Data Release Frequency: No Update Planned

DOT OPS: Incident and Accident Data

Department of Transportation, Office of Pipeline Safety Incident and Accident data.

Date of Government Version: 01/02/2020
Date Data Arrived at EDR: 01/28/2020
Date Made Active in Reports: 04/17/2020
Number of Days to Update: 80

Source: Department of Transportation, Office of Pipeline Safety
Telephone: 202-366-4595
Last EDR Contact: 04/27/2021
Next Scheduled EDR Contact: 08/09/2021
Data Release Frequency: Quarterly

CONSENT: Superfund (CERCLA) Consent Decrees

Major legal settlements that establish responsibility and standards for cleanup at NPL (Superfund) sites. Released periodically by United States District Courts after settlement by parties to litigation matters.

Date of Government Version: 12/31/2020
Date Data Arrived at EDR: 01/13/2021
Date Made Active in Reports: 03/22/2021
Number of Days to Update: 68

Source: Department of Justice, Consent Decree Library
Telephone: Varies
Last EDR Contact: 04/05/2021
Next Scheduled EDR Contact: 07/19/2021
Data Release Frequency: Varies

BRS: Biennial Reporting System

The Biennial Reporting System is a national system administered by the EPA that collects data on the generation and management of hazardous waste. BRS captures detailed data from two groups: Large Quantity Generators (LQG) and Treatment, Storage, and Disposal Facilities.

Date of Government Version: 12/31/2017
Date Data Arrived at EDR: 06/22/2020
Date Made Active in Reports: 11/20/2020
Number of Days to Update: 151

Source: EPA/NTIS
Telephone: 800-424-9346
Last EDR Contact: 03/23/2021
Next Scheduled EDR Contact: 07/05/2021
Data Release Frequency: Biennially

INDIAN RESERV: Indian Reservations

This map layer portrays Indian administered lands of the United States that have any area equal to or greater than 640 acres.

Date of Government Version: 12/31/2014
Date Data Arrived at EDR: 07/14/2015
Date Made Active in Reports: 01/10/2017
Number of Days to Update: 546

Source: USGS
Telephone: 202-208-3710
Last EDR Contact: 04/06/2021
Next Scheduled EDR Contact: 07/19/2021
Data Release Frequency: Semi-Annually

FUSRAP: Formerly Utilized Sites Remedial Action Program

DOE established the Formerly Utilized Sites Remedial Action Program (FUSRAP) in 1974 to remediate sites where radioactive contamination remained from Manhattan Project and early U.S. Atomic Energy Commission (AEC) operations.

Date of Government Version: 08/08/2017
Date Data Arrived at EDR: 09/11/2018
Date Made Active in Reports: 09/14/2018
Number of Days to Update: 3

Source: Department of Energy
Telephone: 202-586-3559
Last EDR Contact: 04/28/2021
Next Scheduled EDR Contact: 08/16/2021
Data Release Frequency: Varies

UMTRA: Uranium Mill Tailings Sites

Uranium ore was mined by private companies for federal government use in national defense programs. When the mills shut down, large piles of the sand-like material (mill tailings) remain after uranium has been extracted from the ore. Levels of human exposure to radioactive materials from the piles are low; however, in some cases tailings were used as construction materials before the potential health hazards of the tailings were recognized.

GOVERNMENT RECORDS SEARCHED / DATA CURRENCY TRACKING

Date of Government Version: 08/30/2019
Date Data Arrived at EDR: 11/15/2019
Date Made Active in Reports: 01/28/2020
Number of Days to Update: 74

Source: Department of Energy
Telephone: 505-845-0011
Last EDR Contact: 05/21/2021
Next Scheduled EDR Contact: 08/30/2021
Data Release Frequency: Varies

LEAD SMELTER 1: Lead Smelter Sites

A listing of former lead smelter site locations.

Date of Government Version: 04/27/2021
Date Data Arrived at EDR: 05/03/2021
Date Made Active in Reports: 05/19/2021
Number of Days to Update: 16

Source: Environmental Protection Agency
Telephone: 703-603-8787
Last EDR Contact: 06/04/2021
Next Scheduled EDR Contact: 07/12/2021
Data Release Frequency: Varies

LEAD SMELTER 2: Lead Smelter Sites

A list of several hundred sites in the U.S. where secondary lead smelting was done from 1931 and 1964. These sites may pose a threat to public health through ingestion or inhalation of contaminated soil or dust

Date of Government Version: 04/05/2001
Date Data Arrived at EDR: 10/27/2010
Date Made Active in Reports: 12/02/2010
Number of Days to Update: 36

Source: American Journal of Public Health
Telephone: 703-305-6451
Last EDR Contact: 12/02/2009
Next Scheduled EDR Contact: N/A
Data Release Frequency: No Update Planned

US AIRS (AFS): Aerometric Information Retrieval System Facility Subsystem (AFS)

The database is a sub-system of Aerometric Information Retrieval System (AIRS). AFS contains compliance data on air pollution point sources regulated by the U.S. EPA and/or state and local air regulatory agencies. This information comes from source reports by various stationary sources of air pollution, such as electric power plants, steel mills, factories, and universities, and provides information about the air pollutants they produce. Action, air program, air program pollutant, and general level plant data. It is used to track emissions and compliance data from industrial plants.

Date of Government Version: 10/12/2016
Date Data Arrived at EDR: 10/26/2016
Date Made Active in Reports: 02/03/2017
Number of Days to Update: 100

Source: EPA
Telephone: 202-564-2496
Last EDR Contact: 09/26/2017
Next Scheduled EDR Contact: 01/08/2018
Data Release Frequency: Annually

US AIRS MINOR: Air Facility System Data

A listing of minor source facilities.

Date of Government Version: 10/12/2016
Date Data Arrived at EDR: 10/26/2016
Date Made Active in Reports: 02/03/2017
Number of Days to Update: 100

Source: EPA
Telephone: 202-564-2496
Last EDR Contact: 09/26/2017
Next Scheduled EDR Contact: 01/08/2018
Data Release Frequency: Annually

MINES VIOLATIONS: MSHA Violation Assessment Data

Mines violation and assessment information. Department of Labor, Mine Safety & Health Administration.

Date of Government Version: 11/24/2020
Date Data Arrived at EDR: 11/30/2020
Date Made Active in Reports: 01/25/2021
Number of Days to Update: 56

Source: DOL, Mine Safety & Health Admi
Telephone: 202-693-9424
Last EDR Contact: 05/26/2021
Next Scheduled EDR Contact: 09/13/2021
Data Release Frequency: Quarterly

US MINES: Mines Master Index File

Contains all mine identification numbers issued for mines active or opened since 1971. The data also includes violation information.

GOVERNMENT RECORDS SEARCHED / DATA CURRENCY TRACKING

Date of Government Version: 02/01/2021
Date Data Arrived at EDR: 02/24/2021
Date Made Active in Reports: 05/19/2021
Number of Days to Update: 84

Source: Department of Labor, Mine Safety and Health Administration
Telephone: 303-231-5959
Last EDR Contact: 05/25/2021
Next Scheduled EDR Contact: 09/06/2021
Data Release Frequency: Semi-Annually

US MINES 2: Ferrous and Nonferrous Metal Mines Database Listing

This map layer includes ferrous (ferrous metal mines are facilities that extract ferrous metals, such as iron ore or molybdenum) and nonferrous (Nonferrous metal mines are facilities that extract nonferrous metals, such as gold, silver, copper, zinc, and lead) metal mines in the United States.

Date of Government Version: 05/06/2020
Date Data Arrived at EDR: 05/27/2020
Date Made Active in Reports: 08/13/2020
Number of Days to Update: 78

Source: USGS
Telephone: 703-648-7709
Last EDR Contact: 05/27/2021
Next Scheduled EDR Contact: 09/06/2021
Data Release Frequency: Varies

US MINES 3: Active Mines & Mineral Plants Database Listing

Active Mines and Mineral Processing Plant operations for commodities monitored by the Minerals Information Team of the USGS.

Date of Government Version: 04/14/2011
Date Data Arrived at EDR: 06/08/2011
Date Made Active in Reports: 09/13/2011
Number of Days to Update: 97

Source: USGS
Telephone: 703-648-7709
Last EDR Contact: 05/27/2021
Next Scheduled EDR Contact: 09/06/2021
Data Release Frequency: Varies

ABANDONED MINES: Abandoned Mines

An inventory of land and water impacted by past mining (primarily coal mining) is maintained by OSMRE to provide information needed to implement the Surface Mining Control and Reclamation Act of 1977 (SMCRA). The inventory contains information on the location, type, and extent of AML impacts, as well as, information on the cost associated with the reclamation of those problems. The inventory is based upon field surveys by State, Tribal, and OSMRE program officials. It is dynamic to the extent that it is modified as new problems are identified and existing problems are reclaimed.

Date of Government Version: 12/11/2020
Date Data Arrived at EDR: 12/11/2020
Date Made Active in Reports: 03/02/2021
Number of Days to Update: 81

Source: Department of Interior
Telephone: 202-208-2609
Last EDR Contact: 06/02/2021
Next Scheduled EDR Contact: 09/20/2021
Data Release Frequency: Quarterly

FINDS: Facility Index System/Facility Registry System

Facility Index System. FINDS contains both facility information and 'pointers' to other sources that contain more detail. EDR includes the following FINDS databases in this report: PCS (Permit Compliance System), AIRS (Aerometric Information Retrieval System), DOCKET (Enforcement Docket used to manage and track information on civil judicial enforcement cases for all environmental statutes), FURS (Federal Underground Injection Control), C-DOCKET (Criminal Docket System used to track criminal enforcement actions for all environmental statutes), FFIS (Federal Facilities Information System), STATE (State Environmental Laws and Statutes), and PADS (PCB Activity Data System).

Date of Government Version: 02/03/2021
Date Data Arrived at EDR: 03/03/2021
Date Made Active in Reports: 04/05/2021
Number of Days to Update: 33

Source: EPA
Telephone: (415) 947-8000
Last EDR Contact: 05/18/2021
Next Scheduled EDR Contact: 09/13/2021
Data Release Frequency: Quarterly

UXO: Unexploded Ordnance Sites

A listing of unexploded ordnance site locations

Date of Government Version: 12/31/2018
Date Data Arrived at EDR: 07/02/2020
Date Made Active in Reports: 09/17/2020
Number of Days to Update: 77

Source: Department of Defense
Telephone: 703-704-1564
Last EDR Contact: 04/13/2021
Next Scheduled EDR Contact: 07/26/2021
Data Release Frequency: Varies

GOVERNMENT RECORDS SEARCHED / DATA CURRENCY TRACKING

ECHO: Enforcement & Compliance History Information

ECHO provides integrated compliance and enforcement information for about 800,000 regulated facilities nationwide.

Date of Government Version: 01/02/2021	Source: Environmental Protection Agency
Date Data Arrived at EDR: 01/08/2021	Telephone: 202-564-2280
Date Made Active in Reports: 03/22/2021	Last EDR Contact: 04/06/2021
Number of Days to Update: 73	Next Scheduled EDR Contact: 07/19/2021
	Data Release Frequency: Quarterly

DOCKET HWC: Hazardous Waste Compliance Docket Listing

A complete list of the Federal Agency Hazardous Waste Compliance Docket Facilities.

Date of Government Version: 11/03/2020	Source: Environmental Protection Agency
Date Data Arrived at EDR: 11/17/2020	Telephone: 202-564-0527
Date Made Active in Reports: 02/09/2021	Last EDR Contact: 05/21/2021
Number of Days to Update: 84	Next Scheduled EDR Contact: 09/06/2021
	Data Release Frequency: Varies

FUELS PROGRAM: EPA Fuels Program Registered Listing

This listing includes facilities that are registered under the Part 80 (Code of Federal Regulations) EPA Fuels Programs. All companies now are required to submit new and updated registrations.

Date of Government Version: 02/17/2021	Source: EPA
Date Data Arrived at EDR: 02/17/2021	Telephone: 800-385-6164
Date Made Active in Reports: 03/22/2021	Last EDR Contact: 05/14/2021
Number of Days to Update: 33	Next Scheduled EDR Contact: 08/30/2021
	Data Release Frequency: Quarterly

CA BOND EXP. PLAN: Bond Expenditure Plan

Department of Health Services developed a site-specific expenditure plan as the basis for an appropriation of Hazardous Substance Cleanup Bond Act funds. It is not updated.

Date of Government Version: 01/01/1989	Source: Department of Health Services
Date Data Arrived at EDR: 07/27/1994	Telephone: 916-255-2118
Date Made Active in Reports: 08/02/1994	Last EDR Contact: 05/31/1994
Number of Days to Update: 6	Next Scheduled EDR Contact: N/A
	Data Release Frequency: No Update Planned

CORTESE: "Cortese" Hazardous Waste & Substances Sites List

The sites for the list are designated by the State Water Resource Control Board (LUST), the Integrated Waste Board (SWF/LS), and the Department of Toxic Substances Control (Cal-Sites).

Date of Government Version: 12/17/2020	Source: CAL EPA/Office of Emergency Information
Date Data Arrived at EDR: 12/17/2020	Telephone: 916-323-3400
Date Made Active in Reports: 03/09/2021	Last EDR Contact: 03/23/2021
Number of Days to Update: 82	Next Scheduled EDR Contact: 07/05/2021
	Data Release Frequency: Quarterly

CUPA LIVERMORE-PLEASANTON: CUPA Facility Listing

list of facilities associated with the various CUPA programs in Livermore-Pleasanton

Date of Government Version: 05/01/2019	Source: Livermore-Pleasanton Fire Department
Date Data Arrived at EDR: 05/14/2019	Telephone: 925-454-2361
Date Made Active in Reports: 07/17/2019	Last EDR Contact: 05/14/2021
Number of Days to Update: 64	Next Scheduled EDR Contact: 08/23/2021
	Data Release Frequency: Varies

DRYCLEANERS: Cleaner Facilities

A list of drycleaner related facilities that have EPA ID numbers. These are facilities with certain SIC codes: power laundries, family and commercial; garment pressing and cleaner's agents; linen supply; coin-operated laundries and cleaning; drycleaning plants, except rugs; carpet and upholster cleaning; industrial launderers; laundry and garment services.

GOVERNMENT RECORDS SEARCHED / DATA CURRENCY TRACKING

Date of Government Version: 03/01/2021
Date Data Arrived at EDR: 03/04/2021
Date Made Active in Reports: 05/20/2021
Number of Days to Update: 77

Source: Department of Toxic Substance Control
Telephone: 916-327-4498
Last EDR Contact: 05/25/2021
Next Scheduled EDR Contact: 09/13/2021
Data Release Frequency: Annually

DRYCLEAN SOUTH COAST: South Coast Air Quality Management District Drycleaner Listing
A listing of dry cleaners in the South Coast Air Quality Management District

Date of Government Version: 02/23/2021
Date Data Arrived at EDR: 02/25/2021
Date Made Active in Reports: 05/19/2021
Number of Days to Update: 83

Source: South Coast Air Quality Management District
Telephone: 909-396-3211
Last EDR Contact: 05/18/2021
Next Scheduled EDR Contact: 09/06/2021
Data Release Frequency: Varies

DRYCLEAN AVAQMD: Antelope Valley Air Quality Management District Drycleaner Listing
A listing of dry cleaners in the Antelope Valley Air Quality Management District.

Date of Government Version: 02/26/2021
Date Data Arrived at EDR: 03/02/2021
Date Made Active in Reports: 05/19/2021
Number of Days to Update: 78

Source: Antelope Valley Air Quality Management District
Telephone: 661-723-8070
Last EDR Contact: 05/25/2021
Next Scheduled EDR Contact: 09/13/2021
Data Release Frequency: Varies

EMI: Emissions Inventory Data

Toxics and criteria pollutant emissions data collected by the ARB and local air pollution agencies.

Date of Government Version: 12/31/2018
Date Data Arrived at EDR: 06/16/2020
Date Made Active in Reports: 08/28/2020
Number of Days to Update: 73

Source: California Air Resources Board
Telephone: 916-322-2990
Last EDR Contact: 03/19/2021
Next Scheduled EDR Contact: 06/28/2021
Data Release Frequency: Varies

ENF: Enforcement Action Listing

A listing of Water Board Enforcement Actions. Formal is everything except Oral/Verbal Communication, Notice of Violation, Expedited Payment Letter, and Staff Enforcement Letter.

Date of Government Version: 12/31/2020
Date Data Arrived at EDR: 01/20/2021
Date Made Active in Reports: 04/09/2021
Number of Days to Update: 79

Source: State Water Resources Control Board
Telephone: 916-445-9379
Last EDR Contact: 04/20/2021
Next Scheduled EDR Contact: 08/02/2021
Data Release Frequency: Varies

Financial Assurance 1: Financial Assurance Information Listing

Financial Assurance information

Date of Government Version: 01/25/2021
Date Data Arrived at EDR: 01/26/2021
Date Made Active in Reports: 04/13/2021
Number of Days to Update: 77

Source: Department of Toxic Substances Control
Telephone: 916-255-3628
Last EDR Contact: 04/14/2021
Next Scheduled EDR Contact: 08/02/2021
Data Release Frequency: Varies

Financial Assurance 2: Financial Assurance Information Listing

A listing of financial assurance information for solid waste facilities. Financial assurance is intended to ensure that resources are available to pay for the cost of closure, post-closure care, and corrective measures if the owner or operator of a regulated facility is unable or unwilling to pay.

Date of Government Version: 02/08/2021
Date Data Arrived at EDR: 02/12/2021
Date Made Active in Reports: 05/05/2021
Number of Days to Update: 82

Source: California Integrated Waste Management Board
Telephone: 916-341-6066
Last EDR Contact: 05/05/2021
Next Scheduled EDR Contact: 08/23/2021
Data Release Frequency: Varies

GOVERNMENT RECORDS SEARCHED / DATA CURRENCY TRACKING

HAZNET: Facility and Manifest Data

Facility and Manifest Data. The data is extracted from the copies of hazardous waste manifests received each year by the DTSC. The annual volume of manifests is typically 700,000 - 1,000,000 annually, representing approximately 350,000 - 500,000 shipments. Data are from the manifests submitted without correction, and therefore many contain some invalid values for data elements such as generator ID, TSD ID, waste category, and disposal method. This database begins with calendar year 1993.

Date of Government Version: 12/31/2019	Source: California Environmental Protection Agency
Date Data Arrived at EDR: 04/15/2020	Telephone: 916-255-1136
Date Made Active in Reports: 07/02/2020	Last EDR Contact: 04/09/2021
Number of Days to Update: 78	Next Scheduled EDR Contact: 07/19/2021
	Data Release Frequency: Annually

ICE: ICE

Contains data pertaining to the Permitted Facilities with Inspections / Enforcements sites tracked in Envirostor.

Date of Government Version: 02/16/2021	Source: Department of Toxic Substances Control
Date Data Arrived at EDR: 02/17/2021	Telephone: 877-786-9427
Date Made Active in Reports: 05/07/2021	Last EDR Contact: 05/14/2021
Number of Days to Update: 79	Next Scheduled EDR Contact: 08/30/2021
	Data Release Frequency: Quarterly

HIST CORTESE: Hazardous Waste & Substance Site List

The sites for the list are designated by the State Water Resource Control Board [LUST], the Integrated Waste Board [SWF/LS], and the Department of Toxic Substances Control [CALSTITES]. This listing is no longer updated by the state agency.

Date of Government Version: 04/01/2001	Source: Department of Toxic Substances Control
Date Data Arrived at EDR: 01/22/2009	Telephone: 916-323-3400
Date Made Active in Reports: 04/08/2009	Last EDR Contact: 01/22/2009
Number of Days to Update: 76	Next Scheduled EDR Contact: N/A
	Data Release Frequency: No Update Planned

HWP: EnviroStor Permitted Facilities Listing

Detailed information on permitted hazardous waste facilities and corrective action ("cleanups") tracked in EnviroStor.

Date of Government Version: 02/16/2021	Source: Department of Toxic Substances Control
Date Data Arrived at EDR: 02/17/2021	Telephone: 916-323-3400
Date Made Active in Reports: 05/10/2021	Last EDR Contact: 05/14/2021
Number of Days to Update: 82	Next Scheduled EDR Contact: 08/30/2021
	Data Release Frequency: Quarterly

HWT: Registered Hazardous Waste Transporter Database

A listing of hazardous waste transporters. In California, unless specifically exempted, it is unlawful for any person to transport hazardous wastes unless the person holds a valid registration issued by DTSC. A hazardous waste transporter registration is valid for one year and is assigned a unique registration number.

Date of Government Version: 01/05/2021	Source: Department of Toxic Substances Control
Date Data Arrived at EDR: 01/05/2021	Telephone: 916-440-7145
Date Made Active in Reports: 03/18/2021	Last EDR Contact: 04/06/2021
Number of Days to Update: 72	Next Scheduled EDR Contact: 07/19/2021
	Data Release Frequency: Quarterly

MINES: Mines Site Location Listing

A listing of mine site locations from the Office of Mine Reclamation.

Date of Government Version: 03/08/2021	Source: Department of Conservation
Date Data Arrived at EDR: 03/09/2021	Telephone: 916-322-1080
Date Made Active in Reports: 03/30/2021	Last EDR Contact: 06/03/2021
Number of Days to Update: 21	Next Scheduled EDR Contact: 09/20/2021
	Data Release Frequency: Quarterly

GOVERNMENT RECORDS SEARCHED / DATA CURRENCY TRACKING

MWMP: Medical Waste Management Program Listing

The Medical Waste Management Program (MWMP) ensures the proper handling and disposal of medical waste by permitting and inspecting medical waste Offsite Treatment Facilities (PDF) and Transfer Stations (PDF) throughout the state. MWMP also oversees all Medical Waste Transporters.

Date of Government Version: 01/29/2021	Source: Department of Public Health
Date Data Arrived at EDR: 03/03/2021	Telephone: 916-558-1784
Date Made Active in Reports: 05/20/2021	Last EDR Contact: 05/28/2021
Number of Days to Update: 78	Next Scheduled EDR Contact: 09/13/2021
	Data Release Frequency: Varies

NPDES: NPDES Permits Listing

A listing of NPDES permits, including stormwater.

Date of Government Version: 02/08/2021	Source: State Water Resources Control Board
Date Data Arrived at EDR: 02/09/2021	Telephone: 916-445-9379
Date Made Active in Reports: 05/04/2021	Last EDR Contact: 05/11/2021
Number of Days to Update: 84	Next Scheduled EDR Contact: 08/23/2021
	Data Release Frequency: Quarterly

PEST LIC: Pesticide Regulation Licenses Listing

A listing of licenses and certificates issued by the Department of Pesticide Regulation. The DPR issues licenses and/or certificates to: Persons and businesses that apply or sell pesticides; Pest control dealers and brokers; Persons who advise on agricultural pesticide applications.

Date of Government Version: 03/02/2021	Source: Department of Pesticide Regulation
Date Data Arrived at EDR: 03/03/2021	Telephone: 916-445-4038
Date Made Active in Reports: 05/20/2021	Last EDR Contact: 05/28/2021
Number of Days to Update: 78	Next Scheduled EDR Contact: 09/13/2021
	Data Release Frequency: Quarterly

PROC: Certified Processors Database

A listing of certified processors.

Date of Government Version: 03/09/2021	Source: Department of Conservation
Date Data Arrived at EDR: 03/09/2021	Telephone: 916-323-3836
Date Made Active in Reports: 03/31/2021	Last EDR Contact: 06/04/2021
Number of Days to Update: 22	Next Scheduled EDR Contact: 09/20/2021
	Data Release Frequency: Quarterly

NOTIFY 65: Proposition 65 Records

Listings of all Proposition 65 incidents reported to counties by the State Water Resources Control Board and the Regional Water Quality Control Board. This database is no longer updated by the reporting agency.

Date of Government Version: 03/12/2021	Source: State Water Resources Control Board
Date Data Arrived at EDR: 03/16/2021	Telephone: 916-445-3846
Date Made Active in Reports: 06/01/2021	Last EDR Contact: 06/08/2021
Number of Days to Update: 77	Next Scheduled EDR Contact: 09/27/2021
	Data Release Frequency: No Update Planned

UIC: UIC Listing

A listing of wells identified as underground injection wells, in the California Oil and Gas Wells database.

Date of Government Version: 03/08/2021	Source: Department of Conservation
Date Data Arrived at EDR: 03/09/2021	Telephone: 916-445-2408
Date Made Active in Reports: 03/31/2021	Last EDR Contact: 06/03/2021
Number of Days to Update: 22	Next Scheduled EDR Contact: 09/20/2021
	Data Release Frequency: Varies

GOVERNMENT RECORDS SEARCHED / DATA CURRENCY TRACKING

UIC GEO: Underground Injection Control Sites (GEOTRACKER)

Underground control injection sites

Date of Government Version: 03/08/2021
Date Data Arrived at EDR: 03/09/2021
Date Made Active in Reports: 03/30/2021
Number of Days to Update: 21

Source: State Water Resource Control Board
Telephone: 866-480-1028
Last EDR Contact: 06/03/2021
Next Scheduled EDR Contact: 09/20/2021
Data Release Frequency: Varies

WASTEWATER PITS: Oil Wastewater Pits Listing

Water officials discovered that oil producers have been dumping chemical-laden wastewater into hundreds of unlined pits that are operating without proper permits. Inspections completed by the Central Valley Regional Water Quality Control Board revealed the existence of previously unidentified waste sites. The water boards review found that more than one-third of the region's active disposal pits are operating without permission.

Date of Government Version: 11/19/2019
Date Data Arrived at EDR: 01/07/2020
Date Made Active in Reports: 03/09/2020
Number of Days to Update: 62

Source: RWQCB, Central Valley Region
Telephone: 559-445-5577
Last EDR Contact: 04/09/2021
Next Scheduled EDR Contact: 07/19/2021
Data Release Frequency: Varies

WDS: Waste Discharge System

Sites which have been issued waste discharge requirements.

Date of Government Version: 06/19/2007
Date Data Arrived at EDR: 06/20/2007
Date Made Active in Reports: 06/29/2007
Number of Days to Update: 9

Source: State Water Resources Control Board
Telephone: 916-341-5227
Last EDR Contact: 05/14/2021
Next Scheduled EDR Contact: 08/30/2021
Data Release Frequency: No Update Planned

WIP: Well Investigation Program Case List

Well Investigation Program case in the San Gabriel and San Fernando Valley area.

Date of Government Version: 07/03/2009
Date Data Arrived at EDR: 07/21/2009
Date Made Active in Reports: 08/03/2009
Number of Days to Update: 13

Source: Los Angeles Water Quality Control Board
Telephone: 213-576-6726
Last EDR Contact: 03/19/2021
Next Scheduled EDR Contact: 07/05/2021
Data Release Frequency: No Update Planned

MILITARY PRIV SITES: Military Privatized Sites (GEOTRACKER)

Military privatized sites

Date of Government Version: 03/08/2021
Date Data Arrived at EDR: 03/09/2021
Date Made Active in Reports: 03/30/2021
Number of Days to Update: 21

Source: State Water Resources Control Board
Telephone: 866-480-1028
Last EDR Contact: 06/03/2021
Next Scheduled EDR Contact: 09/20/2021
Data Release Frequency: Varies

PROJECT: Project Sites (GEOTRACKER)

Projects sites

Date of Government Version: 03/08/2021
Date Data Arrived at EDR: 03/09/2021
Date Made Active in Reports: 03/30/2021
Number of Days to Update: 21

Source: State Water Resources Control Board
Telephone: 866-480-1028
Last EDR Contact: 06/03/2021
Next Scheduled EDR Contact: 09/20/2021
Data Release Frequency: Varies

WDR: Waste Discharge Requirements Listing

In general, the Waste Discharge Requirements (WDRs) Program (sometimes also referred to as the "Non Chapter 15 (Non 15) Program") regulates point discharges that are exempt pursuant to Subsection 20090 of Title 27 and not subject to the Federal Water Pollution Control Act. Exemptions from Title 27 may be granted for nine categories of discharges (e.g., sewage, wastewater, etc.) that meet, and continue to meet, the preconditions listed for each specific exemption. The scope of the WDRs Program also includes the discharge of wastes classified as inert, pursuant to section 20230 of Title 27.

GOVERNMENT RECORDS SEARCHED / DATA CURRENCY TRACKING

Date of Government Version: 03/09/2021
Date Data Arrived at EDR: 03/09/2021
Date Made Active in Reports: 03/31/2021
Number of Days to Update: 22

Source: State Water Resources Control Board
Telephone: 916-341-5810
Last EDR Contact: 06/07/2021
Next Scheduled EDR Contact: 09/20/2021
Data Release Frequency: Quarterly

CIWQS: California Integrated Water Quality System

The California Integrated Water Quality System (CIWQS) is a computer system used by the State and Regional Water Quality Control Boards to track information about places of environmental interest, manage permits and other orders, track inspections, and manage violations and enforcement activities.

Date of Government Version: 11/30/2020
Date Data Arrived at EDR: 12/01/2020
Date Made Active in Reports: 02/12/2021
Number of Days to Update: 73

Source: State Water Resources Control Board
Telephone: 866-794-4977
Last EDR Contact: 05/19/2021
Next Scheduled EDR Contact: 09/13/2021
Data Release Frequency: Varies

CERS: CalEPA Regulated Site Portal Data

The CalEPA Regulated Site Portal database combines data about environmentally regulated sites and facilities in California into a single database. It combines data from a variety of state and federal databases, and provides an overview of regulated activities across the spectrum of environmental programs for any given location in California. These activities include hazardous materials and waste, state and federal cleanups, impacted ground and surface waters, and toxic materials

Date of Government Version: 01/20/2021
Date Data Arrived at EDR: 01/20/2021
Date Made Active in Reports: 04/08/2021
Number of Days to Update: 78

Source: California Environmental Protection Agency
Telephone: 916-323-2514
Last EDR Contact: 04/20/2021
Next Scheduled EDR Contact: 08/02/2021
Data Release Frequency: Varies

NON-CASE INFO: Non-Case Information Sites (GEOTRACKER)

Non-Case Information sites

Date of Government Version: 03/08/2021
Date Data Arrived at EDR: 03/09/2021
Date Made Active in Reports: 03/30/2021
Number of Days to Update: 21

Source: State Water Resources Control Board
Telephone: 866-480-1028
Last EDR Contact: 06/03/2021
Next Scheduled EDR Contact: 09/20/2021
Data Release Frequency: Varies

OTHER OIL GAS: Other Oil & Gas Projects Sites (GEOTRACKER)

Other Oil & Gas Projects sites

Date of Government Version: 03/08/2021
Date Data Arrived at EDR: 03/09/2021
Date Made Active in Reports: 03/30/2021
Number of Days to Update: 21

Source: State Water Resources Control Board
Telephone: 866-480-1028
Last EDR Contact: 06/03/2021
Next Scheduled EDR Contact: 09/20/2021
Data Release Frequency: Varies

PROD WATER PONDS: Produced Water Ponds Sites (GEOTRACKER)

Produced water ponds sites

Date of Government Version: 03/08/2021
Date Data Arrived at EDR: 03/09/2021
Date Made Active in Reports: 03/30/2021
Number of Days to Update: 21

Source: State Water Resources Control Board
Telephone: 866-480-1028
Last EDR Contact: 06/03/2021
Next Scheduled EDR Contact: 09/20/2021
Data Release Frequency: Varies

SAMPLING POINT: Sampling Point ? Public Sites (GEOTRACKER)

Sampling point - public sites

GOVERNMENT RECORDS SEARCHED / DATA CURRENCY TRACKING

Date of Government Version: 03/08/2021
Date Data Arrived at EDR: 03/09/2021
Date Made Active in Reports: 03/30/2021
Number of Days to Update: 21

Source: State Water Resources Control Board
Telephone: 866-480-1028
Last EDR Contact: 06/03/2021
Next Scheduled EDR Contact: 09/20/2021
Data Release Frequency: Varies

WELL STIM PROJ: Well Stimulation Project (GEOTRACKER)

Includes areas of groundwater monitoring plans, a depiction of the monitoring network, and the facilities, boundaries, and subsurface characteristics of the oilfield and the features (oil and gas wells, produced water ponds, UIC wells, water supply wells, etc?) being monitored

Date of Government Version: 03/08/2021
Date Data Arrived at EDR: 03/09/2021
Date Made Active in Reports: 03/30/2021
Number of Days to Update: 21

Source: State Water Resources Control Board
Telephone: 866-480-1028
Last EDR Contact: 06/03/2021
Next Scheduled EDR Contact: 09/20/2021
Data Release Frequency: Varies

PCS INACTIVE: Listing of Inactive PCS Permits

An inactive permit is a facility that has shut down or is no longer discharging.

Date of Government Version: 11/05/2014
Date Data Arrived at EDR: 01/06/2015
Date Made Active in Reports: 05/06/2015
Number of Days to Update: 120

Source: EPA
Telephone: 202-564-2496
Last EDR Contact: 03/31/2021
Next Scheduled EDR Contact: 07/19/2021
Data Release Frequency: Semi-Annually

HWTS: Hazardous Waste Tracking System

DTSC maintains the Hazardous Waste Tracking System that stores ID number information since the early 1980s and manifest data since 1993. The system collects both manifest copies from the generator and destination facility.

Date of Government Version: 04/08/2021
Date Data Arrived at EDR: 04/09/2021
Date Made Active in Reports: 04/20/2021
Number of Days to Update: 11

Source: Department of Toxic Substances Control
Telephone: 916-324-2444
Last EDR Contact: 04/05/2021
Next Scheduled EDR Contact: 07/19/2021
Data Release Frequency: Varies

MINES MRDS: Mineral Resources Data System

Mineral Resources Data System

Date of Government Version: 04/06/2018
Date Data Arrived at EDR: 10/21/2019
Date Made Active in Reports: 10/24/2019
Number of Days to Update: 3

Source: USGS
Telephone: 703-648-6533
Last EDR Contact: 05/27/2021
Next Scheduled EDR Contact: 09/06/2021
Data Release Frequency: Varies

PCS: Permit Compliance System

PCS is a computerized management information system that contains data on National Pollutant Discharge Elimination System (NPDES) permit holding facilities. PCS tracks the permit, compliance, and enforcement status of NPDES facilities.

Date of Government Version: 07/14/2011
Date Data Arrived at EDR: 08/05/2011
Date Made Active in Reports: 09/29/2011
Number of Days to Update: 55

Source: EPA, Office of Water
Telephone: 202-564-2496
Last EDR Contact: 03/31/2021
Next Scheduled EDR Contact: 07/19/2021
Data Release Frequency: Semi-Annually

PCS ENF: Enforcement data

No description is available for this data

GOVERNMENT RECORDS SEARCHED / DATA CURRENCY TRACKING

Date of Government Version: 12/31/2014
Date Data Arrived at EDR: 02/05/2015
Date Made Active in Reports: 03/06/2015
Number of Days to Update: 29

Source: EPA
Telephone: 202-564-2497
Last EDR Contact: 03/31/2021
Next Scheduled EDR Contact: 07/19/2021
Data Release Frequency: Varies

EDR HIGH RISK HISTORICAL RECORDS

EDR Exclusive Records

EDR MGP: EDR Proprietary Manufactured Gas Plants

The EDR Proprietary Manufactured Gas Plant Database includes records of coal gas plants (manufactured gas plants) compiled by EDR's researchers. Manufactured gas sites were used in the United States from the 1800's to 1950's to produce a gas that could be distributed and used as fuel. These plants used whale oil, rosin, coal, or a mixture of coal, oil, and water that also produced a significant amount of waste. Many of the byproducts of the gas production, such as coal tar (oily waste containing volatile and non-volatile chemicals), sludges, oils and other compounds are potentially hazardous to human health and the environment. The byproduct from this process was frequently disposed of directly at the plant site and can remain or spread slowly, serving as a continuous source of soil and groundwater contamination.

Date of Government Version: N/A
Date Data Arrived at EDR: N/A
Date Made Active in Reports: N/A
Number of Days to Update: N/A

Source: EDR, Inc.
Telephone: N/A
Last EDR Contact: N/A
Next Scheduled EDR Contact: N/A
Data Release Frequency: No Update Planned

EDR Hist Auto: EDR Exclusive Historical Auto Stations

EDR has searched selected national collections of business directories and has collected listings of potential gas station/filling station/service station sites that were available to EDR researchers. EDR's review was limited to those categories of sources that might, in EDR's opinion, include gas station/filling station/service station establishments. The categories reviewed included, but were not limited to gas, gas station, gasoline station, filling station, auto, automobile repair, auto service station, service station, etc. This database falls within a category of information EDR classifies as "High Risk Historical Records", or HRHR. EDR's HRHR effort presents unique and sometimes proprietary data about past sites and operations that typically create environmental concerns, but may not show up in current government records searches.

Date of Government Version: N/A
Date Data Arrived at EDR: N/A
Date Made Active in Reports: N/A
Number of Days to Update: N/A

Source: EDR, Inc.
Telephone: N/A
Last EDR Contact: N/A
Next Scheduled EDR Contact: N/A
Data Release Frequency: Varies

EDR Hist Cleaner: EDR Exclusive Historical Cleaners

EDR has searched selected national collections of business directories and has collected listings of potential dry cleaner sites that were available to EDR researchers. EDR's review was limited to those categories of sources that might, in EDR's opinion, include dry cleaning establishments. The categories reviewed included, but were not limited to dry cleaners, cleaners, laundry, laundromat, cleaning/laundry, wash & dry etc. This database falls within a category of information EDR classifies as "High Risk Historical Records", or HRHR. EDR's HRHR effort presents unique and sometimes proprietary data about past sites and operations that typically create environmental concerns, but may not show up in current government records searches.

Date of Government Version: N/A
Date Data Arrived at EDR: N/A
Date Made Active in Reports: N/A
Number of Days to Update: N/A

Source: EDR, Inc.
Telephone: N/A
Last EDR Contact: N/A
Next Scheduled EDR Contact: N/A
Data Release Frequency: Varies

EDR RECOVERED GOVERNMENT ARCHIVES

Exclusive Recovered Govt. Archives

GOVERNMENT RECORDS SEARCHED / DATA CURRENCY TRACKING

RGA LF: Recovered Government Archive Solid Waste Facilities List

The EDR Recovered Government Archive Landfill database provides a list of landfills derived from historical databases and includes many records that no longer appear in current government lists. Compiled from Records formerly available from the Department of Resources Recycling and Recovery in California.

Date of Government Version: N/A	Source: Department of Resources Recycling and Recovery
Date Data Arrived at EDR: 07/01/2013	Telephone: N/A
Date Made Active in Reports: 01/13/2014	Last EDR Contact: 06/01/2012
Number of Days to Update: 196	Next Scheduled EDR Contact: N/A
	Data Release Frequency: Varies

RGA LUST: Recovered Government Archive Leaking Underground Storage Tank

The EDR Recovered Government Archive Leaking Underground Storage Tank database provides a list of LUST incidents derived from historical databases and includes many records that no longer appear in current government lists. Compiled from Records formerly available from the State Water Resources Control Board in California.

Date of Government Version: N/A	Source: State Water Resources Control Board
Date Data Arrived at EDR: 07/01/2013	Telephone: N/A
Date Made Active in Reports: 12/30/2013	Last EDR Contact: 06/01/2012
Number of Days to Update: 182	Next Scheduled EDR Contact: N/A
	Data Release Frequency: Varies

COUNTY RECORDS

ALAMEDA COUNTY:

CS ALAMEDA: Contaminated Sites

A listing of contaminated sites overseen by the Toxic Release Program (oil and groundwater contamination from chemical releases and spills) and the Leaking Underground Storage Tank Program (soil and ground water contamination from leaking petroleum USTs).

Date of Government Version: 01/09/2019	Source: Alameda County Environmental Health Services
Date Data Arrived at EDR: 01/11/2019	Telephone: 510-567-6700
Date Made Active in Reports: 03/05/2019	Last EDR Contact: 03/31/2021
Number of Days to Update: 53	Next Scheduled EDR Contact: 07/19/2021
	Data Release Frequency: Semi-Annually

UST ALAMEDA: Underground Tanks

Underground storage tank sites located in Alameda county.

Date of Government Version: 03/17/2021	Source: Alameda County Environmental Health Services
Date Data Arrived at EDR: 03/18/2021	Telephone: 510-567-6700
Date Made Active in Reports: 03/25/2021	Last EDR Contact: 03/17/2021
Number of Days to Update: 7	Next Scheduled EDR Contact: 07/19/2021
	Data Release Frequency: Semi-Annually

AMADOR COUNTY:

CUPA AMADOR: CUPA Facility List

Cupa Facility List

Date of Government Version: 02/02/2021	Source: Amador County Environmental Health
Date Data Arrived at EDR: 02/04/2021	Telephone: 209-223-6439
Date Made Active in Reports: 04/23/2021	Last EDR Contact: 05/25/2021
Number of Days to Update: 78	Next Scheduled EDR Contact: 08/16/2021
	Data Release Frequency: Varies

BUTTE COUNTY:

GOVERNMENT RECORDS SEARCHED / DATA CURRENCY TRACKING

CUPA BUTTE: CUPA Facility Listing
Cupa facility list.

Date of Government Version: 04/21/2017
Date Data Arrived at EDR: 04/25/2017
Date Made Active in Reports: 08/09/2017
Number of Days to Update: 106

Source: Public Health Department
Telephone: 530-538-7149
Last EDR Contact: 03/31/2021
Next Scheduled EDR Contact: 07/19/2021
Data Release Frequency: No Update Planned

CALVERAS COUNTY:

CUPA CALVERAS: CUPA Facility Listing
Cupa Facility Listing

Date of Government Version: 12/15/2020
Date Data Arrived at EDR: 12/16/2020
Date Made Active in Reports: 12/24/2020
Number of Days to Update: 8

Source: Calveras County Environmental Health
Telephone: 209-754-6399
Last EDR Contact: 04/14/2021
Next Scheduled EDR Contact: 07/05/2021
Data Release Frequency: Quarterly

COLUSA COUNTY:

CUPA COLUSA: CUPA Facility List
Cupa facility list.

Date of Government Version: 04/06/2020
Date Data Arrived at EDR: 04/23/2020
Date Made Active in Reports: 07/10/2020
Number of Days to Update: 78

Source: Health & Human Services
Telephone: 530-458-0396
Last EDR Contact: 04/27/2021
Next Scheduled EDR Contact: 08/16/2021
Data Release Frequency: Semi-Annually

CONTRA COSTA COUNTY:

SL CONTRA COSTA: Site List

List includes sites from the underground tank, hazardous waste generator and business plan/2185 programs.

Date of Government Version: 01/25/2021
Date Data Arrived at EDR: 01/26/2021
Date Made Active in Reports: 04/16/2021
Number of Days to Update: 80

Source: Contra Costa Health Services Department
Telephone: 925-646-2286
Last EDR Contact: 04/20/2021
Next Scheduled EDR Contact: 08/09/2021
Data Release Frequency: Semi-Annually

DEL NORTE COUNTY:

CUPA DEL NORTE: CUPA Facility List
Cupa Facility list

Date of Government Version: 12/17/2020
Date Data Arrived at EDR: 01/28/2021
Date Made Active in Reports: 04/16/2021
Number of Days to Update: 78

Source: Del Norte County Environmental Health Division
Telephone: 707-465-0426
Last EDR Contact: 04/21/2021
Next Scheduled EDR Contact: 08/09/2021
Data Release Frequency: Varies

EL DORADO COUNTY:

GOVERNMENT RECORDS SEARCHED / DATA CURRENCY TRACKING

CUPA EL DORADO: CUPA Facility List CUPA facility list.

Date of Government Version: 02/09/2021
Date Data Arrived at EDR: 02/11/2021
Date Made Active in Reports: 05/05/2021
Number of Days to Update: 83

Source: El Dorado County Environmental Management Department
Telephone: 530-621-6623
Last EDR Contact: 05/05/2021
Next Scheduled EDR Contact: 08/09/2021
Data Release Frequency: Varies

FRESNO COUNTY:

CUPA FRESNO: CUPA Resources List

Certified Unified Program Agency. CUPA's are responsible for implementing a unified hazardous materials and hazardous waste management regulatory program. The agency provides oversight of businesses that deal with hazardous materials, operate underground storage tanks or aboveground storage tanks.

Date of Government Version: 01/14/2021
Date Data Arrived at EDR: 01/15/2021
Date Made Active in Reports: 04/05/2021
Number of Days to Update: 80

Source: Dept. of Community Health
Telephone: 559-445-3271
Last EDR Contact: 04/01/2021
Next Scheduled EDR Contact: 07/12/2021
Data Release Frequency: Semi-Annually

GLENN COUNTY:

CUPA GLENN: CUPA Facility List Cupa facility list

Date of Government Version: 01/22/2018
Date Data Arrived at EDR: 01/24/2018
Date Made Active in Reports: 03/14/2018
Number of Days to Update: 49

Source: Glenn County Air Pollution Control District
Telephone: 830-934-6500
Last EDR Contact: 04/14/2021
Next Scheduled EDR Contact: 08/02/2021
Data Release Frequency: No Update Planned

HUMBOLDT COUNTY:

CUPA HUMBOLDT: CUPA Facility List CUPA facility list.

Date of Government Version: 05/17/2021
Date Data Arrived at EDR: 05/18/2021
Date Made Active in Reports: 05/20/2021
Number of Days to Update: 2

Source: Humboldt County Environmental Health
Telephone: N/A
Last EDR Contact: 05/10/2021
Next Scheduled EDR Contact: 08/30/2021
Data Release Frequency: Semi-Annually

IMPERIAL COUNTY:

CUPA IMPERIAL: CUPA Facility List Cupa facility list.

Date of Government Version: 01/19/2021
Date Data Arrived at EDR: 01/20/2021
Date Made Active in Reports: 04/08/2021
Number of Days to Update: 78

Source: San Diego Border Field Office
Telephone: 760-339-2777
Last EDR Contact: 04/14/2021
Next Scheduled EDR Contact: 08/02/2021
Data Release Frequency: Varies

INYO COUNTY:

GOVERNMENT RECORDS SEARCHED / DATA CURRENCY TRACKING

CUPA INYO: CUPA Facility List Cupa facility list.

Date of Government Version: 04/02/2018
Date Data Arrived at EDR: 04/03/2018
Date Made Active in Reports: 06/14/2018
Number of Days to Update: 77

Source: Inyo County Environmental Health Services
Telephone: 760-878-0238
Last EDR Contact: 05/11/2021
Next Scheduled EDR Contact: 08/30/2021
Data Release Frequency: Varies

KERN COUNTY:

CUPA KERN: CUPA Facility List

A listing of sites included in the Kern County Hazardous Material Business Plan.

Date of Government Version: 10/29/2020
Date Data Arrived at EDR: 10/30/2020
Date Made Active in Reports: 01/15/2021
Number of Days to Update: 77

Source: Kern County Public Health
Telephone: 661-321-3000
Last EDR Contact: 04/27/2021
Next Scheduled EDR Contact: 08/16/2021
Data Release Frequency: Varies

UST KERN: Underground Storage Tank Sites & Tank Listing Kern County Sites and Tanks Listing.

Date of Government Version: 01/19/2021
Date Data Arrived at EDR: 01/21/2021
Date Made Active in Reports: 01/28/2021
Number of Days to Update: 7

Source: Kern County Environment Health Services Department
Telephone: 661-862-8700
Last EDR Contact: 05/25/2021
Next Scheduled EDR Contact: 08/16/2021
Data Release Frequency: Quarterly

KINGS COUNTY:

CUPA KINGS: CUPA Facility List

A listing of sites included in the county's Certified Unified Program Agency database. California's Secretary for Environmental Protection established the unified hazardous materials and hazardous waste regulatory program as required by chapter 6.11 of the California Health and Safety Code. The Unified Program consolidates the administration, permits, inspections, and enforcement activities.

Date of Government Version: 12/03/2020
Date Data Arrived at EDR: 01/26/2021
Date Made Active in Reports: 04/14/2021
Number of Days to Update: 78

Source: Kings County Department of Public Health
Telephone: 559-584-1411
Last EDR Contact: 05/25/2021
Next Scheduled EDR Contact: 08/30/2021
Data Release Frequency: Varies

LAKE COUNTY:

CUPA LAKE: CUPA Facility List Cupa facility list

Date of Government Version: 02/10/2021
Date Data Arrived at EDR: 02/12/2021
Date Made Active in Reports: 03/11/2021
Number of Days to Update: 27

Source: Lake County Environmental Health
Telephone: 707-263-1164
Last EDR Contact: 04/07/2021
Next Scheduled EDR Contact: 07/26/2021
Data Release Frequency: Varies

LASSEN COUNTY:

GOVERNMENT RECORDS SEARCHED / DATA CURRENCY TRACKING

CUPA LASSEN: CUPA Facility List Cupa facility list

Date of Government Version: 07/31/2020
Date Data Arrived at EDR: 08/21/2020
Date Made Active in Reports: 11/09/2020
Number of Days to Update: 80

Source: Lassen County Environmental Health
Telephone: 530-251-8528
Last EDR Contact: 06/04/2021
Next Scheduled EDR Contact: 08/02/2021
Data Release Frequency: Varies

LOS ANGELES COUNTY:

AOCONCERN: Key Areas of Concerns in Los Angeles County

San Gabriel Valley areas where VOC contamination is at or above the MCL as designated by region 9 EPA office. Date of Government Version: 3/30/2009 Exide Site area is a cleanup plan of lead-impacted soil surrounding the former Exide Facility as designated by the DTSC. Date of Government Version: 7/17/2017

Date of Government Version: 03/30/2009
Date Data Arrived at EDR: 03/31/2009
Date Made Active in Reports: 10/23/2009
Number of Days to Update: 206

Source: N/A
Telephone: N/A
Last EDR Contact: 06/08/2021
Next Scheduled EDR Contact: 09/27/2021
Data Release Frequency: No Update Planned

HMS LOS ANGELES: HMS: Street Number List

Industrial Waste and Underground Storage Tank Sites.

Date of Government Version: 01/11/2021
Date Data Arrived at EDR: 01/12/2021
Date Made Active in Reports: 03/25/2021
Number of Days to Update: 72

Source: Department of Public Works
Telephone: 626-458-3517
Last EDR Contact: 04/05/2021
Next Scheduled EDR Contact: 07/19/2021
Data Release Frequency: Semi-Annually

LF LOS ANGELES: List of Solid Waste Facilities

Solid Waste Facilities in Los Angeles County.

Date of Government Version: 01/11/2021
Date Data Arrived at EDR: 01/12/2021
Date Made Active in Reports: 03/26/2021
Number of Days to Update: 73

Source: La County Department of Public Works
Telephone: 818-458-5185
Last EDR Contact: 04/13/2021
Next Scheduled EDR Contact: 07/26/2021
Data Release Frequency: Varies

LF LOS ANGELES CITY: City of Los Angeles Landfills

Landfills owned and maintained by the City of Los Angeles.

Date of Government Version: 01/01/2021
Date Data Arrived at EDR: 02/18/2021
Date Made Active in Reports: 05/10/2021
Number of Days to Update: 81

Source: Engineering & Construction Division
Telephone: 213-473-7869
Last EDR Contact: 04/07/2021
Next Scheduled EDR Contact: 07/26/2021
Data Release Frequency: Varies

LOS ANGELES AST: Active & Inactive AST Inventory

A listing of active & inactive above ground petroleum storage tank site locations, located in the City of Los Angeles.

Date of Government Version: 06/01/2019
Date Data Arrived at EDR: 06/25/2019
Date Made Active in Reports: 08/22/2019
Number of Days to Update: 58

Source: Los Angeles Fire Department
Telephone: 213-978-3800
Last EDR Contact: 03/26/2021
Next Scheduled EDR Contact: 07/05/2021
Data Release Frequency: Varies

GOVERNMENT RECORDS SEARCHED / DATA CURRENCY TRACKING

LOS ANGELES CO LF METHANE: Methane Producing Landfills

This data was created on April 30, 2012 to represent known disposal sites in Los Angeles County that may produce and emanate methane gas. The shapefile contains disposal sites within Los Angeles County that once accepted degradable refuse material. Information used to create this data was extracted from a landfill survey performed by County Engineers (Major Waste System Map, 1973) as well as historical records from CalRecycle, Regional Water Quality Control Board, and Los Angeles County Department of Public Health

Date of Government Version: 02/04/2021	Source: Los Angeles County Department of Public Works
Date Data Arrived at EDR: 04/16/2021	Telephone: 626-458-6973
Date Made Active in Reports: 04/21/2021	Last EDR Contact: 04/16/2021
Number of Days to Update: 5	Next Scheduled EDR Contact: 07/26/2021
	Data Release Frequency: No Update Planned

LOS ANGELES HM: Active & Inactive Hazardous Materials Inventory

A listing of active & inactive hazardous materials facility locations, located in the City of Los Angeles.

Date of Government Version: 06/01/2019	Source: Los Angeles Fire Department
Date Data Arrived at EDR: 06/25/2019	Telephone: 213-978-3800
Date Made Active in Reports: 08/22/2019	Last EDR Contact: 03/26/2021
Number of Days to Update: 58	Next Scheduled EDR Contact: 07/05/2021
	Data Release Frequency: Varies

LOS ANGELES UST: Active & Inactive UST Inventory

A listing of active & inactive underground storage tank site locations and underground storage tank historical sites, located in the City of Los Angeles.

Date of Government Version: 06/01/2019	Source: Los Angeles Fire Department
Date Data Arrived at EDR: 06/25/2019	Telephone: 213-978-3800
Date Made Active in Reports: 08/22/2019	Last EDR Contact: 03/26/2021
Number of Days to Update: 58	Next Scheduled EDR Contact: 07/05/2021
	Data Release Frequency: Varies

SITE MIT LOS ANGELES: Site Mitigation List

Industrial sites that have had some sort of spill or complaint.

Date of Government Version: 10/19/2020	Source: Community Health Services
Date Data Arrived at EDR: 01/12/2021	Telephone: 323-890-7806
Date Made Active in Reports: 03/26/2021	Last EDR Contact: 04/16/2021
Number of Days to Update: 73	Next Scheduled EDR Contact: 07/26/2021
	Data Release Frequency: Annually

UST EL SEGUNDO: City of El Segundo Underground Storage Tank

Underground storage tank sites located in El Segundo city.

Date of Government Version: 01/21/2017	Source: City of El Segundo Fire Department
Date Data Arrived at EDR: 04/19/2017	Telephone: 310-524-2236
Date Made Active in Reports: 05/10/2017	Last EDR Contact: 04/07/2021
Number of Days to Update: 21	Next Scheduled EDR Contact: 07/26/2021
	Data Release Frequency: No Update Planned

UST LONG BEACH: City of Long Beach Underground Storage Tank

Underground storage tank sites located in the city of Long Beach.

Date of Government Version: 04/22/2019	Source: City of Long Beach Fire Department
Date Data Arrived at EDR: 04/23/2019	Telephone: 562-570-2563
Date Made Active in Reports: 06/27/2019	Last EDR Contact: 04/14/2021
Number of Days to Update: 65	Next Scheduled EDR Contact: 08/02/2021
	Data Release Frequency: Varies

GOVERNMENT RECORDS SEARCHED / DATA CURRENCY TRACKING

UST TORRANCE: City of Torrance Underground Storage Tank
Underground storage tank sites located in the city of Torrance.

Date of Government Version: 09/11/2020	Source: City of Torrance Fire Department
Date Data Arrived at EDR: 10/07/2020	Telephone: 310-618-2973
Date Made Active in Reports: 12/23/2020	Last EDR Contact: 04/23/2021
Number of Days to Update: 77	Next Scheduled EDR Contact: 08/02/2021
	Data Release Frequency: Semi-Annually

MADERA COUNTY:

CUPA MADERA: CUPA Facility List

A listing of sites included in the county's Certified Unified Program Agency database. California's Secretary for Environmental Protection established the unified hazardous materials and hazardous waste regulatory program as required by chapter 6.11 of the California Health and Safety Code. The Unified Program consolidates the administration, permits, inspections, and enforcement activities.

Date of Government Version: 08/10/2020	Source: Madera County Environmental Health
Date Data Arrived at EDR: 08/12/2020	Telephone: 559-675-7823
Date Made Active in Reports: 10/23/2020	Last EDR Contact: 05/12/2021
Number of Days to Update: 72	Next Scheduled EDR Contact: 08/30/2021
	Data Release Frequency: Varies

MARIN COUNTY:

UST MARIN: Underground Storage Tank Sites
Currently permitted USTs in Marin County.

Date of Government Version: 09/26/2018	Source: Public Works Department Waste Management
Date Data Arrived at EDR: 10/04/2018	Telephone: 415-473-6647
Date Made Active in Reports: 11/02/2018	Last EDR Contact: 03/25/2021
Number of Days to Update: 29	Next Scheduled EDR Contact: 07/12/2021
	Data Release Frequency: Semi-Annually

MENDOCINO COUNTY:

UST MENDOCINO: Mendocino County UST Database
A listing of underground storage tank locations in Mendocino County.

Date of Government Version: 12/21/2020	Source: Department of Public Health
Date Data Arrived at EDR: 12/21/2020	Telephone: 707-463-4466
Date Made Active in Reports: 03/10/2021	Last EDR Contact: 05/18/2021
Number of Days to Update: 79	Next Scheduled EDR Contact: 09/06/2021
	Data Release Frequency: Annually

MERCED COUNTY:

CUPA MERCED: CUPA Facility List
CUPA facility list.

Date of Government Version: 02/04/2021	Source: Merced County Environmental Health
Date Data Arrived at EDR: 02/09/2021	Telephone: 209-381-1094
Date Made Active in Reports: 02/18/2021	Last EDR Contact: 05/12/2021
Number of Days to Update: 9	Next Scheduled EDR Contact: 08/30/2021
	Data Release Frequency: Varies

MONO COUNTY:

GOVERNMENT RECORDS SEARCHED / DATA CURRENCY TRACKING

CUPA MONO: CUPA Facility List CUPA Facility List

Date of Government Version: 02/22/2021
Date Data Arrived at EDR: 03/02/2021
Date Made Active in Reports: 05/19/2021
Number of Days to Update: 78

Source: Mono County Health Department
Telephone: 760-932-5580
Last EDR Contact: 06/02/2021
Next Scheduled EDR Contact: 09/06/3021
Data Release Frequency: Varies

MONTEREY COUNTY:

CUPA MONTEREY: CUPA Facility Listing

CUPA Program listing from the Environmental Health Division.

Date of Government Version: 01/08/2021
Date Data Arrived at EDR: 01/12/2021
Date Made Active in Reports: 03/25/2021
Number of Days to Update: 72

Source: Monterey County Health Department
Telephone: 831-796-1297
Last EDR Contact: 03/25/2021
Next Scheduled EDR Contact: 07/12/2021
Data Release Frequency: Varies

NAPA COUNTY:

LUST NAPA: Sites With Reported Contamination

A listing of leaking underground storage tank sites located in Napa county.

Date of Government Version: 01/09/2017
Date Data Arrived at EDR: 01/11/2017
Date Made Active in Reports: 03/02/2017
Number of Days to Update: 50

Source: Napa County Department of Environmental Management
Telephone: 707-253-4269
Last EDR Contact: 05/18/2021
Next Scheduled EDR Contact: 09/06/2021
Data Release Frequency: No Update Planned

UST NAPA: Closed and Operating Underground Storage Tank Sites

Underground storage tank sites located in Napa county.

Date of Government Version: 09/05/2019
Date Data Arrived at EDR: 09/09/2019
Date Made Active in Reports: 10/31/2019
Number of Days to Update: 52

Source: Napa County Department of Environmental Management
Telephone: 707-253-4269
Last EDR Contact: 05/18/2021
Next Scheduled EDR Contact: 09/06/2021
Data Release Frequency: No Update Planned

NEVADA COUNTY:

CUPA NEVADA: CUPA Facility List

CUPA facility list.

Date of Government Version: 02/03/2021
Date Data Arrived at EDR: 02/04/2021
Date Made Active in Reports: 04/23/2021
Number of Days to Update: 78

Source: Community Development Agency
Telephone: 530-265-1467
Last EDR Contact: 04/21/2021
Next Scheduled EDR Contact: 08/09/2021
Data Release Frequency: Varies

ORANGE COUNTY:

IND_SITE ORANGE: List of Industrial Site Cleanups

Petroleum and non-petroleum spills.

GOVERNMENT RECORDS SEARCHED / DATA CURRENCY TRACKING

Date of Government Version: 02/01/2021
Date Data Arrived at EDR: 02/04/2021
Date Made Active in Reports: 04/23/2021
Number of Days to Update: 78

Source: Health Care Agency
Telephone: 714-834-3446
Last EDR Contact: 04/29/2021
Next Scheduled EDR Contact: 08/16/2021
Data Release Frequency: Annually

LUST ORANGE: List of Underground Storage Tank Cleanups
Orange County Underground Storage Tank Cleanups (LUST).

Date of Government Version: 03/01/2021
Date Data Arrived at EDR: 05/03/2021
Date Made Active in Reports: 05/12/2021
Number of Days to Update: 9

Source: Health Care Agency
Telephone: 714-834-3446
Last EDR Contact: 04/29/2021
Next Scheduled EDR Contact: 08/16/2021
Data Release Frequency: Quarterly

UST ORANGE: List of Underground Storage Tank Facilities
Orange County Underground Storage Tank Facilities (UST).

Date of Government Version: 02/01/2021
Date Data Arrived at EDR: 02/02/2021
Date Made Active in Reports: 04/20/2021
Number of Days to Update: 77

Source: Health Care Agency
Telephone: 714-834-3446
Last EDR Contact: 04/30/2021
Next Scheduled EDR Contact: 08/16/2021
Data Release Frequency: Quarterly

PLACER COUNTY:

MS PLACER: Master List of Facilities

List includes aboveground tanks, underground tanks and cleanup sites.

Date of Government Version: 05/25/2021
Date Data Arrived at EDR: 05/26/2021
Date Made Active in Reports: 06/01/2021
Number of Days to Update: 6

Source: Placer County Health and Human Services
Telephone: 530-745-2363
Last EDR Contact: 05/25/2021
Next Scheduled EDR Contact: 09/13/2021
Data Release Frequency: Semi-Annually

PLUMAS COUNTY:

CUPA PLUMAS: CUPA Facility List

Plumas County CUPA Program facilities.

Date of Government Version: 03/31/2019
Date Data Arrived at EDR: 04/23/2019
Date Made Active in Reports: 06/26/2019
Number of Days to Update: 64

Source: Plumas County Environmental Health
Telephone: 530-283-6355
Last EDR Contact: 04/14/2021
Next Scheduled EDR Contact: 08/02/2021
Data Release Frequency: Varies

RIVERSIDE COUNTY:

LUST RIVERSIDE: Listing of Underground Tank Cleanup Sites
Riverside County Underground Storage Tank Cleanup Sites (LUST).

Date of Government Version: 01/13/2021
Date Data Arrived at EDR: 01/14/2021
Date Made Active in Reports: 03/10/2021
Number of Days to Update: 55

Source: Department of Environmental Health
Telephone: 951-358-5055
Last EDR Contact: 06/08/2021
Next Scheduled EDR Contact: 09/27/2021
Data Release Frequency: Quarterly

GOVERNMENT RECORDS SEARCHED / DATA CURRENCY TRACKING

UST RIVERSIDE: Underground Storage Tank Tank List

Underground storage tank sites located in Riverside county.

Date of Government Version: 01/13/2021
Date Data Arrived at EDR: 01/14/2021
Date Made Active in Reports: 03/10/2021
Number of Days to Update: 55

Source: Department of Environmental Health
Telephone: 951-358-5055
Last EDR Contact: 06/07/2021
Next Scheduled EDR Contact: 09/26/2021
Data Release Frequency: Quarterly

SACRAMENTO COUNTY:

CS SACRAMENTO: Toxic Site Clean-Up List

List of sites where unauthorized releases of potentially hazardous materials have occurred.

Date of Government Version: 02/18/2020
Date Data Arrived at EDR: 03/31/2020
Date Made Active in Reports: 06/15/2020
Number of Days to Update: 76

Source: Sacramento County Environmental Management
Telephone: 916-875-8406
Last EDR Contact: 03/31/2021
Next Scheduled EDR Contact: 07/12/2021
Data Release Frequency: Quarterly

ML SACRAMENTO: Master Hazardous Materials Facility List

Any business that has hazardous materials on site - hazardous material storage sites, underground storage tanks, waste generators.

Date of Government Version: 02/24/2020
Date Data Arrived at EDR: 03/31/2020
Date Made Active in Reports: 06/17/2020
Number of Days to Update: 78

Source: Sacramento County Environmental Management
Telephone: 916-875-8406
Last EDR Contact: 04/01/2021
Next Scheduled EDR Contact: 07/12/2021
Data Release Frequency: Quarterly

SAN BENITO COUNTY:

CUPA SAN BENITO: CUPA Facility List

Cupa facility list

Date of Government Version: 04/28/2021
Date Data Arrived at EDR: 04/29/2021
Date Made Active in Reports: 05/03/2021
Number of Days to Update: 4

Source: San Benito County Environmental Health
Telephone: N/A
Last EDR Contact: 04/27/2021
Next Scheduled EDR Contact: 08/16/2021
Data Release Frequency: Varies

SAN BERNARDINO COUNTY:

PERMITS SAN BERNARDINO: Hazardous Material Permits

This listing includes underground storage tanks, medical waste handlers/generators, hazardous materials handlers, hazardous waste generators, and waste oil generators/handlers.

Date of Government Version: 05/19/2021
Date Data Arrived at EDR: 05/19/2021
Date Made Active in Reports: 06/07/2021
Number of Days to Update: 19

Source: San Bernardino County Fire Department Hazardous Materials Division
Telephone: 909-387-3041
Last EDR Contact: 05/03/2021
Next Scheduled EDR Contact: 08/16/2021
Data Release Frequency: Quarterly

SAN DIEGO COUNTY:

GOVERNMENT RECORDS SEARCHED / DATA CURRENCY TRACKING

HMMD SAN DIEGO: Hazardous Materials Management Division Database

The database includes: HE58 - This report contains the business name, site address, business phone number, establishment 'H' permit number, type of permit, and the business status. HE17 - In addition to providing the same information provided in the HE58 listing, HE17 provides inspection dates, violations received by the establishment, hazardous waste generated, the quantity, method of storage, treatment/disposal of waste and the hauler, and information on underground storage tanks. Unauthorized Release List - Includes a summary of environmental contamination cases in San Diego County (underground tank cases, non-tank cases, groundwater contamination, and soil contamination are included.)

Date of Government Version: 03/02/2021
Date Data Arrived at EDR: 03/03/2021
Date Made Active in Reports: 05/21/2021
Number of Days to Update: 79

Source: Hazardous Materials Management Division
Telephone: 619-338-2268
Last EDR Contact: 05/28/2021
Next Scheduled EDR Contact: 09/13/2021
Data Release Frequency: Quarterly

LF SAN DIEGO: Solid Waste Facilities

San Diego County Solid Waste Facilities.

Date of Government Version: 10/01/2020
Date Data Arrived at EDR: 11/23/2020
Date Made Active in Reports: 02/08/2021
Number of Days to Update: 77

Source: Department of Health Services
Telephone: 619-338-2209
Last EDR Contact: 05/21/2021
Next Scheduled EDR Contact: 08/02/2021
Data Release Frequency: Varies

SAN DIEGO CO LOP: Local Oversight Program Listing

A listing of all LOP release sites that are or were under the County of San Diego's jurisdiction. Included are closed or transferred cases, open cases, and cases that did not have a case type indicated. The cases without a case type are mostly complaints; however, some of them could be LOP cases.

Date of Government Version: 07/14/2020
Date Data Arrived at EDR: 07/16/2020
Date Made Active in Reports: 09/29/2020
Number of Days to Update: 75

Source: Department of Environmental Health
Telephone: 858-505-6874
Last EDR Contact: 04/14/2021
Next Scheduled EDR Contact: 08/02/2021
Data Release Frequency: Varies

SAN DIEGO CO SAM: Environmental Case Listing

The listing contains all underground tank release cases and projects pertaining to properties contaminated with hazardous substances that are actively under review by the Site Assessment and Mitigation Program.

Date of Government Version: 03/23/2010
Date Data Arrived at EDR: 06/15/2010
Date Made Active in Reports: 07/09/2010
Number of Days to Update: 24

Source: San Diego County Department of Environmental Health
Telephone: 619-338-2371
Last EDR Contact: 05/25/2021
Next Scheduled EDR Contact: 09/13/2021
Data Release Frequency: No Update Planned

SAN FRANCISCO COUNTY:

CUPA SAN FRANCISCO CO: CUPA Facility Listing

Cupa facilities

Date of Government Version: 02/11/2021
Date Data Arrived at EDR: 02/11/2021
Date Made Active in Reports: 05/05/2021
Number of Days to Update: 83

Source: San Francisco County Department of Environmental Health
Telephone: 415-252-3896
Last EDR Contact: 04/27/2021
Next Scheduled EDR Contact: 08/16/2021
Data Release Frequency: Varies

LUST SAN FRANCISCO: Local Oversight Facilities

A listing of leaking underground storage tank sites located in San Francisco county.

GOVERNMENT RECORDS SEARCHED / DATA CURRENCY TRACKING

Date of Government Version: 09/19/2008
Date Data Arrived at EDR: 09/19/2008
Date Made Active in Reports: 09/29/2008
Number of Days to Update: 10

Source: Department Of Public Health San Francisco County
Telephone: 415-252-3920
Last EDR Contact: 04/27/2021
Next Scheduled EDR Contact: 08/16/2021
Data Release Frequency: No Update Planned

UST SAN FRANCISCO: Underground Storage Tank Information

Underground storage tank sites located in San Francisco county.

Date of Government Version: 02/11/2021
Date Data Arrived at EDR: 02/11/2021
Date Made Active in Reports: 05/05/2021
Number of Days to Update: 83

Source: Department of Public Health
Telephone: 415-252-3920
Last EDR Contact: 04/27/2021
Next Scheduled EDR Contact: 08/16/2021
Data Release Frequency: Quarterly

SAN JOAQUIN COUNTY:

UST SAN JOAQUIN: San Joaquin Co. UST

A listing of underground storage tank locations in San Joaquin county.

Date of Government Version: 06/22/2018
Date Data Arrived at EDR: 06/26/2018
Date Made Active in Reports: 07/11/2018
Number of Days to Update: 15

Source: Environmental Health Department
Telephone: N/A
Last EDR Contact: 06/08/2021
Next Scheduled EDR Contact: 09/27/2021
Data Release Frequency: Semi-Annually

SAN LUIS OBISPO COUNTY:

CUPA SAN LUIS OBISPO: CUPA Facility List

Cupa Facility List.

Date of Government Version: 05/07/2021
Date Data Arrived at EDR: 05/11/2021
Date Made Active in Reports: 05/14/2021
Number of Days to Update: 3

Source: San Luis Obispo County Public Health Department
Telephone: 805-781-5596
Last EDR Contact: 05/06/2021
Next Scheduled EDR Contact: 08/30/2021
Data Release Frequency: Varies

SAN MATEO COUNTY:

BI SAN MATEO: Business Inventory

List includes Hazardous Materials Business Plan, hazardous waste generators, and underground storage tanks.

Date of Government Version: 02/20/2020
Date Data Arrived at EDR: 02/20/2020
Date Made Active in Reports: 04/24/2020
Number of Days to Update: 64

Source: San Mateo County Environmental Health Services Division
Telephone: 650-363-1921
Last EDR Contact: 03/12/2021
Next Scheduled EDR Contact: 06/21/2021
Data Release Frequency: Annually

LUST SAN MATEO: Fuel Leak List

A listing of leaking underground storage tank sites located in San Mateo county.

Date of Government Version: 03/29/2019
Date Data Arrived at EDR: 03/29/2019
Date Made Active in Reports: 05/29/2019
Number of Days to Update: 61

Source: San Mateo County Environmental Health Services Division
Telephone: 650-363-1921
Last EDR Contact: 06/02/2021
Next Scheduled EDR Contact: 09/20/2021
Data Release Frequency: Semi-Annually

SANTA BARBARA COUNTY:

GOVERNMENT RECORDS SEARCHED / DATA CURRENCY TRACKING

CUPA SANTA BARBARA: CUPA Facility Listing

CUPA Program Listing from the Environmental Health Services division.

Date of Government Version: 09/08/2011
Date Data Arrived at EDR: 09/09/2011
Date Made Active in Reports: 10/07/2011
Number of Days to Update: 28

Source: Santa Barbara County Public Health Department
Telephone: 805-686-8167
Last EDR Contact: 05/12/2021
Next Scheduled EDR Contact: 08/30/2021
Data Release Frequency: No Update Planned

SANTA CLARA COUNTY:

CUPA SANTA CLARA: Cupa Facility List

Cupa facility list

Date of Government Version: 02/24/2021
Date Data Arrived at EDR: 02/26/2021
Date Made Active in Reports: 05/19/2021
Number of Days to Update: 28

Source: Department of Environmental Health
Telephone: 408-918-1973
Last EDR Contact: 05/12/2021
Next Scheduled EDR Contact: 08/30/2021
Data Release Frequency: Varies

HIST LUST SANTA CLARA: HIST LUST - Fuel Leak Site Activity Report

A listing of open and closed leaking underground storage tanks. This listing is no longer updated by the county. Leaking underground storage tanks are now handled by the Department of Environmental Health.

Date of Government Version: 03/29/2005
Date Data Arrived at EDR: 03/30/2005
Date Made Active in Reports: 04/21/2005
Number of Days to Update: 22

Source: Santa Clara Valley Water District
Telephone: 408-265-2600
Last EDR Contact: 03/23/2009
Next Scheduled EDR Contact: 06/22/2009
Data Release Frequency: No Update Planned

LUST SANTA CLARA: LOP Listing

A listing of leaking underground storage tanks located in Santa Clara county.

Date of Government Version: 03/03/2014
Date Data Arrived at EDR: 03/05/2014
Date Made Active in Reports: 03/18/2014
Number of Days to Update: 13

Source: Department of Environmental Health
Telephone: 408-918-3417
Last EDR Contact: 05/18/2021
Next Scheduled EDR Contact: 09/06/2021
Data Release Frequency: No Update Planned

SAN JOSE HAZMAT: Hazardous Material Facilities

Hazardous material facilities, including underground storage tank sites.

Date of Government Version: 11/03/2020
Date Data Arrived at EDR: 11/05/2020
Date Made Active in Reports: 01/26/2021
Number of Days to Update: 82

Source: City of San Jose Fire Department
Telephone: 408-535-7694
Last EDR Contact: 05/21/2021
Next Scheduled EDR Contact: 08/16/2021
Data Release Frequency: Annually

SANTA CRUZ COUNTY:

CUPA SANTA CRUZ: CUPA Facility List

CUPA facility listing.

Date of Government Version: 01/21/2017
Date Data Arrived at EDR: 02/22/2017
Date Made Active in Reports: 05/23/2017
Number of Days to Update: 90

Source: Santa Cruz County Environmental Health
Telephone: 831-464-2761
Last EDR Contact: 05/12/2021
Next Scheduled EDR Contact: 08/30/2021
Data Release Frequency: Varies

SHASTA COUNTY:

GOVERNMENT RECORDS SEARCHED / DATA CURRENCY TRACKING

CUPA SHASTA: CUPA Facility List Cupa Facility List.

Date of Government Version: 06/15/2017
Date Data Arrived at EDR: 06/19/2017
Date Made Active in Reports: 08/09/2017
Number of Days to Update: 51

Source: Shasta County Department of Resource Management
Telephone: 530-225-5789
Last EDR Contact: 05/12/2021
Next Scheduled EDR Contact: 08/30/2021
Data Release Frequency: Varies

SOLANO COUNTY:

LUST SOLANO: Leaking Underground Storage Tanks

A listing of leaking underground storage tank sites located in Solano county.

Date of Government Version: 06/04/2019
Date Data Arrived at EDR: 06/06/2019
Date Made Active in Reports: 08/13/2019
Number of Days to Update: 68

Source: Solano County Department of Environmental Management
Telephone: 707-784-6770
Last EDR Contact: 05/25/2021
Next Scheduled EDR Contact: 09/13/2021
Data Release Frequency: Quarterly

UST SOLANO: Underground Storage Tanks

Underground storage tank sites located in Solano county.

Date of Government Version: 12/03/2020
Date Data Arrived at EDR: 12/03/2020
Date Made Active in Reports: 02/18/2021
Number of Days to Update: 77

Source: Solano County Department of Environmental Management
Telephone: 707-784-6770
Last EDR Contact: 06/08/2021
Next Scheduled EDR Contact: 09/12/2021
Data Release Frequency: Quarterly

SONOMA COUNTY:

CUPA SONOMA: Cupa Facility List Cupa Facility list

Date of Government Version: 12/15/2020
Date Data Arrived at EDR: 12/16/2020
Date Made Active in Reports: 12/23/2020
Number of Days to Update: 7

Source: County of Sonoma Fire & Emergency Services Department
Telephone: 707-565-1174
Last EDR Contact: 03/19/2021
Next Scheduled EDR Contact: 07/05/2021
Data Release Frequency: Varies

LUST SONOMA: Leaking Underground Storage Tank Sites

A listing of leaking underground storage tank sites located in Sonoma county.

Date of Government Version: 01/05/2021
Date Data Arrived at EDR: 01/06/2021
Date Made Active in Reports: 03/18/2021
Number of Days to Update: 71

Source: Department of Health Services
Telephone: 707-565-6565
Last EDR Contact: 03/19/2021
Next Scheduled EDR Contact: 07/05/2021
Data Release Frequency: Quarterly

STANISLAUS COUNTY:

CUPA STANISLAUS: CUPA Facility List Cupa facility list

Date of Government Version: 02/09/2021
Date Data Arrived at EDR: 02/11/2021
Date Made Active in Reports: 05/05/2021
Number of Days to Update: 83

Source: Stanislaus County Department of Environmental Protection
Telephone: 209-525-6751
Last EDR Contact: 04/21/2021
Next Scheduled EDR Contact: 07/26/2021
Data Release Frequency: Varies

SUTTER COUNTY:

GOVERNMENT RECORDS SEARCHED / DATA CURRENCY TRACKING

UST SUTTER: Underground Storage Tanks

Underground storage tank sites located in Sutter county.

Date of Government Version: 03/01/2021
Date Data Arrived at EDR: 03/02/2021
Date Made Active in Reports: 05/19/2021
Number of Days to Update: 78

Source: Sutter County Environmental Health Services
Telephone: 530-822-7500
Last EDR Contact: 05/25/2021
Next Scheduled EDR Contact: 09/13/2021
Data Release Frequency: Semi-Annually

TEHAMA COUNTY:

CUPA TEHAMA: CUPA Facility List

Cupa facilities

Date of Government Version: 01/13/2021
Date Data Arrived at EDR: 01/14/2021
Date Made Active in Reports: 04/06/2021
Number of Days to Update: 82

Source: Tehama County Department of Environmental Health
Telephone: 530-527-8020
Last EDR Contact: 04/27/2021
Next Scheduled EDR Contact: 08/16/2021
Data Release Frequency: Varies

TRINITY COUNTY:

CUPA TRINITY: CUPA Facility List

Cupa facility list

Date of Government Version: 01/19/2021
Date Data Arrived at EDR: 01/20/2021
Date Made Active in Reports: 04/08/2021
Number of Days to Update: 78

Source: Department of Toxic Substances Control
Telephone: 760-352-0381
Last EDR Contact: 04/14/2021
Next Scheduled EDR Contact: 08/02/2021
Data Release Frequency: Varies

TULARE COUNTY:

CUPA TULARE: CUPA Facility List

Cupa program facilities

Date of Government Version: 02/02/2021
Date Data Arrived at EDR: 02/04/2021
Date Made Active in Reports: 04/23/2021
Number of Days to Update: 78

Source: Tulare County Environmental Health Services Division
Telephone: 559-624-7400
Last EDR Contact: 04/27/2021
Next Scheduled EDR Contact: 08/16/2021
Data Release Frequency: Varies

TUOLUMNE COUNTY:

CUPA TUOLUMNE: CUPA Facility List

Cupa facility list

Date of Government Version: 04/23/2018
Date Data Arrived at EDR: 04/25/2018
Date Made Active in Reports: 06/25/2018
Number of Days to Update: 61

Source: Division of Environmental Health
Telephone: 209-533-5633
Last EDR Contact: 04/14/2021
Next Scheduled EDR Contact: 08/02/2021
Data Release Frequency: Varies

VENTURA COUNTY:

GOVERNMENT RECORDS SEARCHED / DATA CURRENCY TRACKING

BWT VENTURA: Business Plan, Hazardous Waste Producers, and Operating Underground Tanks

The BWT list indicates by site address whether the Environmental Health Division has Business Plan (B), Waste Producer (W), and/or Underground Tank (T) information.

Date of Government Version: 12/28/2020	Source: Ventura County Environmental Health Division
Date Data Arrived at EDR: 01/29/2021	Telephone: 805-654-2813
Date Made Active in Reports: 04/22/2021	Last EDR Contact: 04/19/2021
Number of Days to Update: 83	Next Scheduled EDR Contact: 08/02/2021
	Data Release Frequency: Quarterly

LF VENTURA: Inventory of Illegal Abandoned and Inactive Sites

Ventura County Inventory of Closed, Illegal Abandoned, and Inactive Sites.

Date of Government Version: 12/01/2011	Source: Environmental Health Division
Date Data Arrived at EDR: 12/01/2011	Telephone: 805-654-2813
Date Made Active in Reports: 01/19/2012	Last EDR Contact: 03/25/2021
Number of Days to Update: 49	Next Scheduled EDR Contact: 07/12/2021
	Data Release Frequency: No Update Planned

LUST VENTURA: Listing of Underground Tank Cleanup Sites

Ventura County Underground Storage Tank Cleanup Sites (LUST).

Date of Government Version: 05/29/2008	Source: Environmental Health Division
Date Data Arrived at EDR: 06/24/2008	Telephone: 805-654-2813
Date Made Active in Reports: 07/31/2008	Last EDR Contact: 05/05/2021
Number of Days to Update: 37	Next Scheduled EDR Contact: 08/23/2021
	Data Release Frequency: No Update Planned

MED WASTE VENTURA: Medical Waste Program List

To protect public health and safety and the environment from potential exposure to disease causing agents, the Environmental Health Division Medical Waste Program regulates the generation, handling, storage, treatment and disposal of medical waste throughout the County.

Date of Government Version: 03/29/2021	Source: Ventura County Resource Management Agency
Date Data Arrived at EDR: 04/21/2021	Telephone: 805-654-2813
Date Made Active in Reports: 04/23/2021	Last EDR Contact: 04/19/2021
Number of Days to Update: 2	Next Scheduled EDR Contact: 08/02/2021
	Data Release Frequency: Quarterly

UST VENTURA: Underground Tank Closed Sites List

Ventura County Operating Underground Storage Tank Sites (UST)/Underground Tank Closed Sites List.

Date of Government Version: 03/01/2021	Source: Environmental Health Division
Date Data Arrived at EDR: 03/09/2021	Telephone: 805-654-2813
Date Made Active in Reports: 03/31/2021	Last EDR Contact: 06/04/2021
Number of Days to Update: 22	Next Scheduled EDR Contact: 09/20/2021
	Data Release Frequency: Quarterly

YOLO COUNTY:

UST YOLO: Underground Storage Tank Comprehensive Facility Report

Underground storage tank sites located in Yolo county.

Date of Government Version: 12/21/2020	Source: Yolo County Department of Health
Date Data Arrived at EDR: 12/23/2020	Telephone: 530-666-8646
Date Made Active in Reports: 01/04/2021	Last EDR Contact: 03/26/2021
Number of Days to Update: 12	Next Scheduled EDR Contact: 07/12/2021
	Data Release Frequency: Annually

YUBA COUNTY:

GOVERNMENT RECORDS SEARCHED / DATA CURRENCY TRACKING

CUPA YUBA: CUPA Facility List

CUPA facility listing for Yuba County.

Date of Government Version: 04/21/2021
Date Data Arrived at EDR: 04/22/2021
Date Made Active in Reports: 05/12/2021
Number of Days to Update: 20

Source: Yuba County Environmental Health Department
Telephone: 530-749-7523
Last EDR Contact: 04/24/2021
Next Scheduled EDR Contact: 08/09/2021
Data Release Frequency: Varies

OTHER DATABASE(S)

Depending on the geographic area covered by this report, the data provided in these specialty databases may or may not be complete. For example, the existence of wetlands information data in a specific report does not mean that all wetlands in the area covered by the report are included. Moreover, the absence of any reported wetlands information does not necessarily mean that wetlands do not exist in the area covered by the report.

CT MANIFEST: Hazardous Waste Manifest Data

Facility and manifest data. Manifest is a document that lists and tracks hazardous waste from the generator through transporters to a tsd facility.

Date of Government Version: 10/05/2020
Date Data Arrived at EDR: 02/17/2021
Date Made Active in Reports: 05/10/2021
Number of Days to Update: 82

Source: Department of Energy & Environmental Protection
Telephone: 860-424-3375
Last EDR Contact: 05/11/2021
Next Scheduled EDR Contact: 08/23/2021
Data Release Frequency: No Update Planned

NJ MANIFEST: Manifest Information

Hazardous waste manifest information.

Date of Government Version: 12/31/2018
Date Data Arrived at EDR: 04/10/2019
Date Made Active in Reports: 05/16/2019
Number of Days to Update: 36

Source: Department of Environmental Protection
Telephone: N/A
Last EDR Contact: 04/09/2021
Next Scheduled EDR Contact: 07/19/2021
Data Release Frequency: Annually

NY MANIFEST: Facility and Manifest Data

Manifest is a document that lists and tracks hazardous waste from the generator through transporters to a TSD facility.

Date of Government Version: 01/01/2019
Date Data Arrived at EDR: 04/29/2020
Date Made Active in Reports: 07/10/2020
Number of Days to Update: 72

Source: Department of Environmental Conservation
Telephone: 518-402-8651
Last EDR Contact: 04/30/2021
Next Scheduled EDR Contact: 08/09/2021
Data Release Frequency: Quarterly

PA MANIFEST: Manifest Information

Hazardous waste manifest information.

Date of Government Version: 06/30/2018
Date Data Arrived at EDR: 07/19/2019
Date Made Active in Reports: 09/10/2019
Number of Days to Update: 53

Source: Department of Environmental Protection
Telephone: 717-783-8990
Last EDR Contact: 04/09/2021
Next Scheduled EDR Contact: 07/26/2021
Data Release Frequency: Annually

RI MANIFEST: Manifest information

Hazardous waste manifest information

Date of Government Version: 12/31/2019
Date Data Arrived at EDR: 02/11/2021
Date Made Active in Reports: 02/24/2021
Number of Days to Update: 13

Source: Department of Environmental Management
Telephone: 401-222-2797
Last EDR Contact: 05/13/2021
Next Scheduled EDR Contact: 08/30/2021
Data Release Frequency: Annually

GOVERNMENT RECORDS SEARCHED / DATA CURRENCY TRACKING

WI MANIFEST: Manifest Information

Hazardous waste manifest information.

Date of Government Version: 05/31/2018
Date Data Arrived at EDR: 06/19/2019
Date Made Active in Reports: 09/03/2019
Number of Days to Update: 76

Source: Department of Natural Resources
Telephone: N/A
Last EDR Contact: 06/03/2021
Next Scheduled EDR Contact: 09/20/2021
Data Release Frequency: Annually

Oil/Gas Pipelines

Source: Endeavor Business Media

Petroleum Bundle (Crude Oil, Refined Products, Petrochemicals, Gas Liquids (LPG/NGL), and Specialty Gases (Miscellaneous)) N = Natural Gas Bundle (Natural Gas, Gas Liquids (LPG/NGL), and Specialty Gases (Miscellaneous)). This map includes information copyrighted by Endeavor Business Media. This information is provided on a best effort basis and Endeavor Business Media does not guarantee its accuracy nor warrant its fitness for any particular purpose. Such information has been reprinted with the permission of Endeavor Business Media.

Electric Power Transmission Line Data

Source: Endeavor Business Media

This map includes information copyrighted by Endeavor Business Media. This information is provided on a best effort basis and Endeavor Business Media does not guarantee its accuracy nor warrant its fitness for any particular purpose. Such information has been reprinted with the permission of Endeavor Business Media.

Sensitive Receptors: There are individuals deemed sensitive receptors due to their fragile immune systems and special sensitivity to environmental discharges. These sensitive receptors typically include the elderly, the sick, and children. While the location of all sensitive receptors cannot be determined, EDR indicates those buildings and facilities - schools, daycares, hospitals, medical centers, and nursing homes - where individuals who are sensitive receptors are likely to be located.

AHA Hospitals:

Source: American Hospital Association, Inc.
Telephone: 312-280-5991

The database includes a listing of hospitals based on the American Hospital Association's annual survey of hospitals.

Medical Centers: Provider of Services Listing

Source: Centers for Medicare & Medicaid Services
Telephone: 410-786-3000

A listing of hospitals with Medicare provider number, produced by Centers of Medicare & Medicaid Services, a federal agency within the U.S. Department of Health and Human Services.

Nursing Homes

Source: National Institutes of Health
Telephone: 301-594-6248

Information on Medicare and Medicaid certified nursing homes in the United States.

Public Schools

Source: National Center for Education Statistics
Telephone: 202-502-7300

The National Center for Education Statistics' primary database on elementary and secondary public education in the United States. It is a comprehensive, annual, national statistical database of all public elementary and secondary schools and school districts, which contains data that are comparable across all states.

Private Schools

Source: National Center for Education Statistics
Telephone: 202-502-7300

The National Center for Education Statistics' primary database on private school locations in the United States.

Daycare Centers: Licensed Facilities

Source: Department of Social Services
Telephone: 916-657-4041

Flood Zone Data: This data was obtained from the Federal Emergency Management Agency (FEMA). It depicts 100-year and 500-year flood zones as defined by FEMA. It includes the National Flood Hazard Layer (NFHL) which incorporates Flood Insurance Rate Map (FIRM) data and Q3 data from FEMA in areas not covered by NFHL.

Source: FEMA
Telephone: 877-336-2627
Date of Government Version: 2003, 2015

GOVERNMENT RECORDS SEARCHED / DATA CURRENCY TRACKING

NWI: National Wetlands Inventory. This data, available in select counties across the country, was obtained by EDR in 2002, 2005 and 2010 from the U.S. Fish and Wildlife Service.

State Wetlands Data: Wetland Inventory
Source: Department of Fish and Wildlife
Telephone: 916-445-0411

Current USGS 7.5 Minute Topographic Map
Source: U.S. Geological Survey

STREET AND ADDRESS INFORMATION

© 2015 TomTom North America, Inc. All rights reserved. This material is proprietary and the subject of copyright protection and other intellectual property rights owned by or licensed to Tele Atlas North America, Inc. The use of this material is subject to the terms of a license agreement. You will be held liable for any unauthorized copying or disclosure of this material.

GEOCHECK[®] - PHYSICAL SETTING SOURCE ADDENDUM

TARGET PROPERTY ADDRESS

ORANGE PARK ACRES WELL REPLACEMENT PROJECT
678 NORTH GRAVIER STREET
ORANGE, CA 92869

TARGET PROPERTY COORDINATES

Latitude (North):	33.798158 - 33° 47' 53.37"
Longitude (West):	117.81472 - 117° 48' 52.99"
Universal Transverse Mercator:	Zone 11
UTM X (Meters):	424582.2
UTM Y (Meters):	3739881.0
Elevation:	298 ft. above sea level

USGS TOPOGRAPHIC MAP

Target Property Map:	5641308 ORANGE, CA
Version Date:	2012

EDR's GeoCheck Physical Setting Source Addendum is provided to assist the environmental professional in forming an opinion about the impact of potential contaminant migration.

Assessment of the impact of contaminant migration generally has two principle investigative components:

1. Groundwater flow direction, and
2. Groundwater flow velocity.

Groundwater flow direction may be impacted by surface topography, hydrology, hydrogeology, characteristics of the soil, and nearby wells. Groundwater flow velocity is generally impacted by the nature of the geologic strata.

GEOCHECK® - PHYSICAL SETTING SOURCE SUMMARY

GROUNDWATER FLOW DIRECTION INFORMATION

Groundwater flow direction for a particular site is best determined by a qualified environmental professional using site-specific well data. If such data is not reasonably ascertainable, it may be necessary to rely on other sources of information, such as surface topographic information, hydrologic information, hydrogeologic data collected on nearby properties, and regional groundwater flow information (from deep aquifers).

TOPOGRAPHIC INFORMATION

Surface topography may be indicative of the direction of surficial groundwater flow. This information can be used to assist the environmental professional in forming an opinion about the impact of nearby contaminated properties or, should contamination exist on the target property, what downgradient sites might be impacted.

TARGET PROPERTY TOPOGRAPHY

General Topographic Gradient: General West

SURROUNDING TOPOGRAPHY: ELEVATION PROFILES

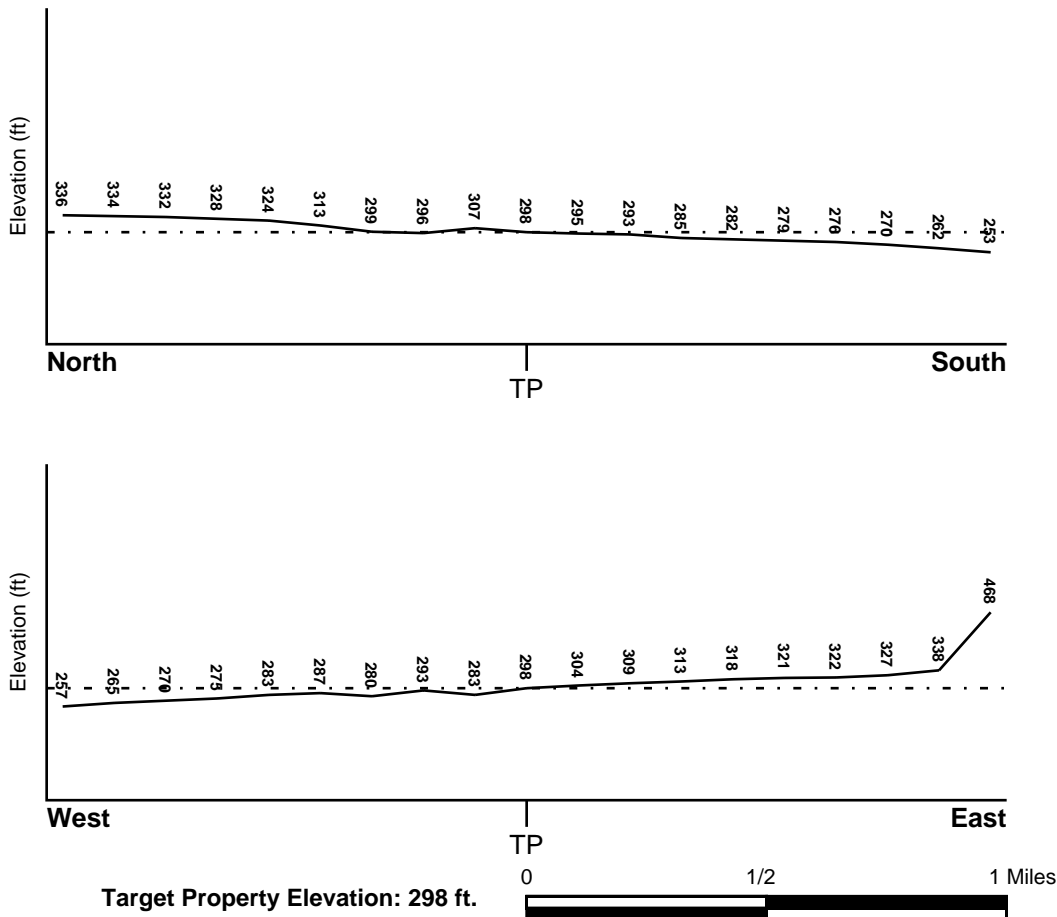

Source: Topography has been determined from the USGS 7.5' Digital Elevation Model and should be evaluated on a relative (not an absolute) basis. Relative elevation information between sites of close proximity should be field verified.

GEOCHECK® - PHYSICAL SETTING SOURCE SUMMARY

HYDROLOGIC INFORMATION

Surface water can act as a hydrologic barrier to groundwater flow. Such hydrologic information can be used to assist the environmental professional in forming an opinion about the impact of nearby contaminated properties or, should contamination exist on the target property, what downgradient sites might be impacted.

Refer to the Physical Setting Source Map following this summary for hydrologic information (major waterways and bodies of water).

FEMA FLOOD ZONE

<u>Flood Plain Panel at Target Property</u>	<u>FEMA Source Type</u>
06059C0162J	FEMA FIRM Flood data
<u>Additional Panels in search area:</u>	<u>FEMA Source Type</u>
06059C0154J	FEMA FIRM Flood data
06059C0158J	FEMA FIRM Flood data
06059C0166J	FEMA FIRM Flood data

NATIONAL WETLAND INVENTORY

<u>NWI Quad at Target Property</u>	<u>NWI Electronic Data Coverage</u>
ORANGE	YES - refer to the Overview Map and Detail Map

HYDROGEOLOGIC INFORMATION

Hydrogeologic information obtained by installation of wells on a specific site can often be an indicator of groundwater flow direction in the immediate area. Such hydrogeologic information can be used to assist the environmental professional in forming an opinion about the impact of nearby contaminated properties or, should contamination exist on the target property, what downgradient sites might be impacted.

Site-Specific Hydrogeological Data*:

Search Radius:	1.25 miles
Status:	Not found

AQUIFLOW®

Search Radius: 1.000 Mile.

EDR has developed the AQUIFLOW Information System to provide data on the general direction of groundwater flow at specific points. EDR has reviewed reports submitted by environmental professionals to regulatory authorities at select sites and has extracted the date of the report, groundwater flow direction as determined hydrogeologically, and the depth to water table.

<u>MAP ID</u>	<u>LOCATION FROM TP</u>	<u>GENERAL DIRECTION GROUNDWATER FLOW</u>
39	1/2 - 1 Mile SSW	NW
1G	1/2 - 1 Mile SSW	NW

For additional site information, refer to Physical Setting Source Map Findings.

GEOCHECK® - PHYSICAL SETTING SOURCE SUMMARY

GROUNDWATER FLOW VELOCITY INFORMATION

Groundwater flow velocity information for a particular site is best determined by a qualified environmental professional using site specific geologic and soil strata data. If such data are not reasonably ascertainable, it may be necessary to rely on other sources of information, including geologic age identification, rock stratigraphic unit and soil characteristics data collected on nearby properties and regional soil information. In general, contaminant plumes move more quickly through sandy-gravelly types of soils than silty-clayey types of soils.

GEOLOGIC INFORMATION IN GENERAL AREA OF TARGET PROPERTY

Geologic information can be used by the environmental professional in forming an opinion about the relative speed at which contaminant migration may be occurring.

ROCK STRATIGRAPHIC UNIT

Era:	Cenozoic
System:	Tertiary
Series:	Miocene
Code:	Tm (decoded above as Era, System & Series)

GEOLOGIC AGE IDENTIFICATION

Category: Stratified Sequence

Geologic Age and Rock Stratigraphic Unit Source: P.G. Schruben, R.E. Arndt and W.J. Bawiec, Geology of the Conterminous U.S. at 1:2,500,000 Scale - a digital representation of the 1974 P.B. King and H.M. Beikman Map, USGS Digital Data Series DDS - 11 (1994).

SSURGO SOIL MAP - 6531282.2s

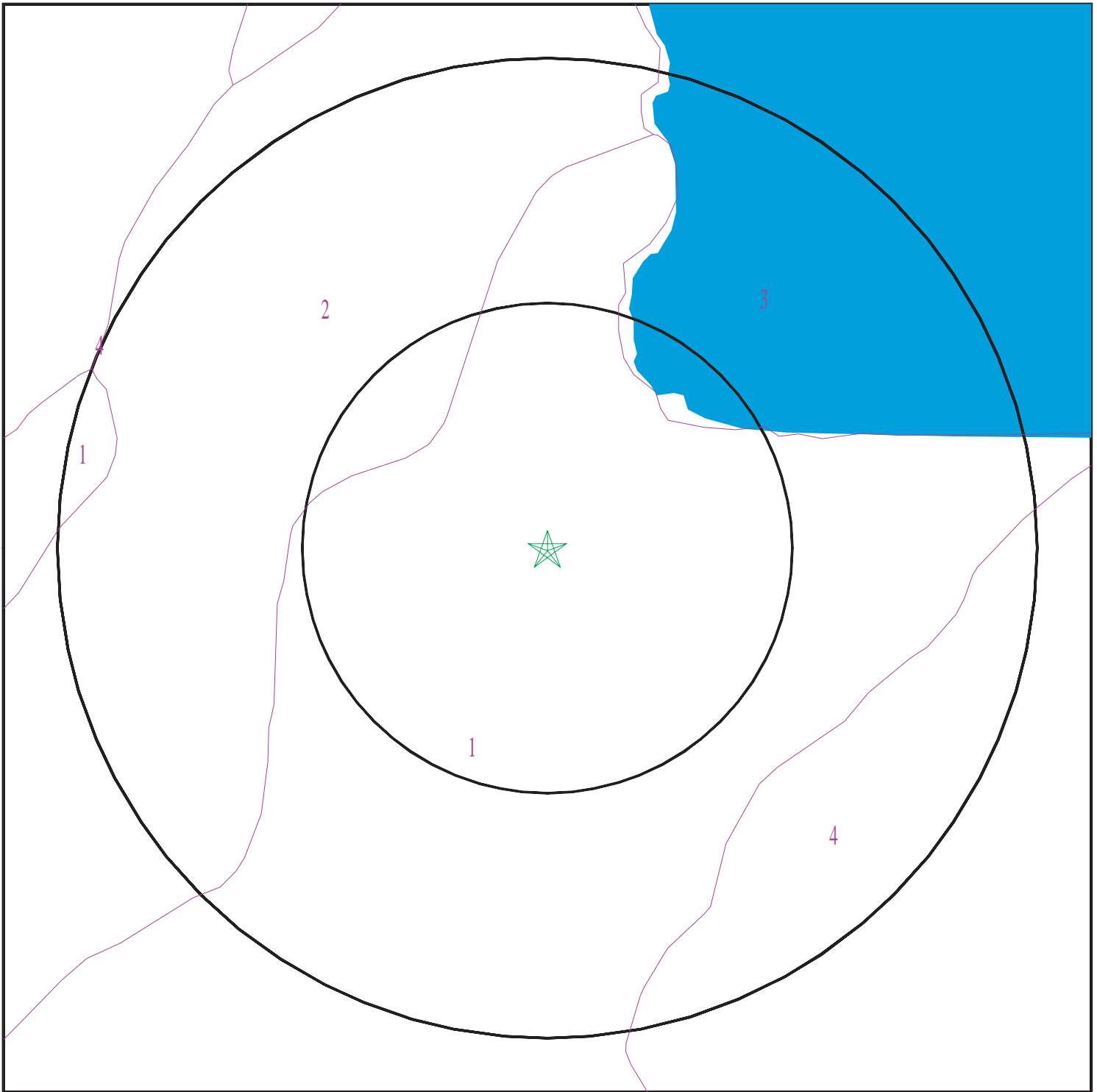

- ★ Target Property
- ∩ SSURGO Soil
- ∩ Water

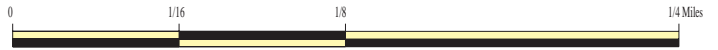

SITE NAME: Orange Park Acres Well Replacement Project
ADDRESS: 678 North Gravier Street
Orange CA 92869
LAT/LONG: 33.798158 / 117.81472

CLIENT: Psomas
CONTACT: Janet Powell
INQUIRY #: 6531282.2s
DATE: June 10, 2021 4:06 pm

GEOCHECK® - PHYSICAL SETTING SOURCE SUMMARY

DOMINANT SOIL COMPOSITION IN GENERAL AREA OF TARGET PROPERTY

The U.S. Department of Agriculture's (USDA) Soil Conservation Service (SCS) leads the National Cooperative Soil Survey (NCSS) and is responsible for collecting, storing, maintaining and distributing soil survey information for privately owned lands in the United States. A soil map in a soil survey is a representation of soil patterns in a landscape. The following information is based on Soil Conservation Service SSURGO data.

Soil Map ID: 1

Soil Component Name: SAN EMIGDIO

Soil Surface Texture: fine sandy loam

Hydrologic Group: Class B - Moderate infiltration rates. Deep and moderately deep, moderately well and well drained soils with moderately coarse textures.

Soil Drainage Class: Well drained

Hydric Status: Not hydric

Corrosion Potential - Uncoated Steel: High

Depth to Bedrock Min: > 0 inches

Depth to Watertable Min: > 0 inches

Soil Layer Information							
Layer	Boundary		Soil Texture Class	Classification		Saturated hydraulic conductivity micro m/sec	Soil Reaction (pH)
	Upper	Lower		AASHTO Group	Unified Soil		
1	0 inches	7 inches	fine sandy loam	Not reported	Not reported	Max: 42 Min: 14	Max: 8.4 Min: 7.9
2	7 inches	61 inches	stratified gravelly loamy coarse sand to very fine sandy loam	Not reported	Not reported	Max: 42 Min: 14	Max: 8.4 Min: 7.9

Soil Map ID: 2

Soil Component Name: PITS

Soil Surface Texture: extremely gravelly coarse sand

Hydrologic Group: Class A - High infiltration rates. Soils are deep, well drained to excessively drained sands and gravels.

Soil Drainage Class:

GEOCHECK® - PHYSICAL SETTING SOURCE SUMMARY

Hydric Status: Not hydric

Corrosion Potential - Uncoated Steel: Not Reported

Depth to Bedrock Min: > 0 inches

Depth to Watertable Min: > 0 inches

Soil Layer Information							
Layer	Boundary		Soil Texture Class	Classification		Saturated hydraulic conductivity micro m/sec	Soil Reaction (pH)
	Upper	Lower		AASHTO Group	Unified Soil		
1	0 inches	5 inches	extremely gravelly coarse sand	Not reported	Not reported	Max: 141 Min: 42	Max: Min:
2	5 inches	59 inches	extremely gravelly sand	Not reported	Not reported	Max: 141 Min: 42	Max: Min:

Soil Map ID: 3

Soil Component Name: Water

Soil Surface Texture: extremely gravelly coarse sand

Hydrologic Group: Class A - High infiltration rates. Soils are deep, well drained to excessively drained sands and gravels.

Soil Drainage Class:
Hydric Status: Not hydric

Corrosion Potential - Uncoated Steel: Not Reported

Depth to Bedrock Min: > 0 inches

Depth to Watertable Min: > 0 inches

No Layer Information available.

Soil Map ID: 4

Soil Component Name: MODJESKA

Soil Surface Texture: gravelly loam

Hydrologic Group: Class B - Moderate infiltration rates. Deep and moderately deep, moderately well and well drained soils with moderately coarse textures.

Soil Drainage Class: Well drained

GEOCHECK® - PHYSICAL SETTING SOURCE SUMMARY

Hydric Status: Not hydric

Corrosion Potential - Uncoated Steel: Low

Depth to Bedrock Min: > 0 inches

Depth to Watertable Min: > 0 inches

Soil Layer Information							
Layer	Boundary		Soil Texture Class	Classification		Saturated hydraulic conductivity micro m/sec	Soil Reaction (pH)
	Upper	Lower		AASHTO Group	Unified Soil		
1	0 inches	14 inches	gravelly loam	Not reported	Not reported	Max: 141 Min: 141	Max: 6.5 Min: 6.1
2	14 inches	62 inches	very cobbly loam	Not reported	Not reported	Max: 141 Min: 141	Max: 6.5 Min: 6.1
3	62 inches	70 inches	very gravelly loamy sand	Not reported	Not reported	Max: 141 Min: 141	Max: 6.5 Min: 6.1

LOCAL / REGIONAL WATER AGENCY RECORDS

EDR Local/Regional Water Agency records provide water well information to assist the environmental professional in assessing sources that may impact ground water flow direction, and in forming an opinion about the impact of contaminant migration on nearby drinking water wells.

WELL SEARCH DISTANCE INFORMATION

<u>DATABASE</u>	<u>SEARCH DISTANCE (miles)</u>
Federal USGS	1.000
Federal FRDS PWS	Nearest PWS within 1 mile
State Database	1.000

FEDERAL USGS WELL INFORMATION

<u>MAP ID</u>	<u>WELL ID</u>	<u>LOCATION FROM TP</u>
E22	USGS40000138296	1/4 - 1/2 Mile WNW
H33	USGS40000138191	1/2 - 1 Mile SW
H38	USGS40000138190	1/2 - 1 Mile SW
J49	USGS40000138359	1/2 - 1 Mile NNW

FEDERAL FRDS PUBLIC WATER SUPPLY SYSTEM INFORMATION

<u>MAP ID</u>	<u>WELL ID</u>	<u>LOCATION FROM TP</u>
---------------	----------------	-------------------------

GEOCHECK® - PHYSICAL SETTING SOURCE SUMMARY

FEDERAL FRDS PUBLIC WATER SUPPLY SYSTEM INFORMATION

MAP ID	WELL ID	LOCATION FROM TP
No PWS System Found		

Note: PWS System location is not always the same as well location.

STATE DATABASE WELL INFORMATION

MAP ID	WELL ID	LOCATION FROM TP
A1	CAPFAS000000144	0 - 1/8 Mile North
A2	CADDW0000010038	0 - 1/8 Mile North
A3	CADDW0000014515	0 - 1/8 Mile ENE
A4	CADDW0000006264	0 - 1/8 Mile ENE
5	CADWR0000008432	1/8 - 1/4 Mile SE
B6	CADDW0000000899	1/8 - 1/4 Mile NW
7	CADWR0000032353	1/8 - 1/4 Mile SW
B8	CADWR0000017663	1/8 - 1/4 Mile NW
C9	CADWR0000007242	1/8 - 1/4 Mile West
10	CADDW0000022070	1/8 - 1/4 Mile NNE
B11	5045	1/8 - 1/4 Mile NW
B12	5046	1/8 - 1/4 Mile NW
B13	5044	1/8 - 1/4 Mile NW
C14	CADWR8000005576	1/8 - 1/4 Mile West
D15	CADDW0000008242	1/4 - 1/2 Mile SW
D16	CAPFAS000001375	1/4 - 1/2 Mile SW
17	5048	1/4 - 1/2 Mile SW
E18	CAPFAS000001325	1/4 - 1/2 Mile WNW
E19	CADDW0000012501	1/4 - 1/2 Mile WNW
E20	CAUSGSN00011008	1/4 - 1/2 Mile WNW
E21	CALLNL000001292	1/4 - 1/2 Mile WNW
23	CADWR0000027580	1/2 - 1 Mile SW
F24	CADWR8000005616	1/2 - 1 Mile NE
F25	CADWR8000005617	1/2 - 1 Mile NE
G26	CADWR8000005634	1/2 - 1 Mile North
H27	CADWR0000014458	1/2 - 1 Mile SSW
G28	CADWR0000015617	1/2 - 1 Mile North
H29	CAPFAS000001364	1/2 - 1 Mile SSW
H30	CADDW0000001063	1/2 - 1 Mile SSW
H31	CAPFAS000000722	1/2 - 1 Mile SSW
H32	CADDW0000006265	1/2 - 1 Mile SSW
H34	CAUSGSN00014090	1/2 - 1 Mile SW
H35	CALLNL000000939	1/2 - 1 Mile SW
H36	CALLNL000001116	1/2 - 1 Mile SW
H37	CADWR0000035928	1/2 - 1 Mile SW
G40	CADWR8000005637	1/2 - 1 Mile North
I41	CAEDF0000118625	1/2 - 1 Mile SSE
I42	CAEDF0000114811	1/2 - 1 Mile SSE
I43	CAEDF0000110342	1/2 - 1 Mile SSE
44	CADPR0000000041	1/2 - 1 Mile SE
J45	CAPFAS000000542	1/2 - 1 Mile NNW
J46	CADDW0000011800	1/2 - 1 Mile NNW
J47	CAUSGS000002258	1/2 - 1 Mile NNW

GEOCHECK® - PHYSICAL SETTING SOURCE SUMMARY

STATE DATABASE WELL INFORMATION

<u>MAP ID</u>	<u>WELL ID</u>	<u>LOCATION FROM TP</u>
J48	CAUSGSN00003132	1/2 - 1 Mile NNW
50	CADWR0000028779	1/2 - 1 Mile WSW
51	5043	1/2 - 1 Mile East
J52	CAPFAS000000949	1/2 - 1 Mile North
J53	CADDW0000016600	1/2 - 1 Mile North
K54	CAEDF0000132165	1/2 - 1 Mile SSW
K55	CAEDF0000045816	1/2 - 1 Mile SSW
56	5040	1/2 - 1 Mile North
K57	CAEDF0000117440	1/2 - 1 Mile SSW
58	CADWR8000005540	1/2 - 1 Mile SW
L59	CADPR0000000040	1/2 - 1 Mile NNE
60	CADDW0000000377	1/2 - 1 Mile NNE
L61	5039	1/2 - 1 Mile NNE
L62	CADPR0000001473	1/2 - 1 Mile NNE
63	CADPR0000002842	1/2 - 1 Mile WSW

PHYSICAL SETTING SOURCE MAP - 6531282.2s



- County Boundary
- Major Roads
- Contour Lines
- Earthquake Fault Lines
- Earthquake epicenter, Richter 5 or greater
- Water Wells
- Public Water Supply Wells
- Cluster of Multiple Icons

- Groundwater Flow Direction
- Indeterminate Groundwater Flow at Location
- Groundwater Flow Varies at Location
- Closest Hydrogeological Data
- Oil, gas or related wells

SITE NAME: Orange Park Acres Well Replacement Project
 ADDRESS: 678 North Gravier Street
 Orange CA 92869
 LAT/LONG: 33.798158 / 117.81472

CLIENT: Psomas
 CONTACT: Janet Powell
 INQUIRY #: 6531282.2s
 DATE: June 10, 2021 4:06 pm

GEOCHECK® - PHYSICAL SETTING SOURCE MAP FINDINGS

Map ID
Direction
Distance
Elevation

Database EDR ID Number

A1
North
0 - 1/8 Mile
Higher

CA WELLS CAPFAS000000144

Well ID:	3010092-077	Well Type:	MUNICIPAL
Source:	Department of Health Services		
Other Name:	WELL OPA-1 - INACTIVE	GAMA PFAS Testing:	Yes
Groundwater Quality Data:	https://gamagroundwater.waterboards.ca.gov/gama/gamamap/public/GamaDataDisplay.asp?dataset=DHS&samp_date=&global_id=&assigned_name=3010092-077&store_num=		
GeoTracker Data:	Not Reported		

A2
North
0 - 1/8 Mile
Higher

CA WELLS CADDW0000010038

Well ID:	3010092-077	Well Type:	MUNICIPAL
Source:	Department of Health Services		
Other Name:	WELL OPA-1 - INACTIVE	GAMA PFAS Testing:	Not Reported
Groundwater Quality Data:	https://gamagroundwater.waterboards.ca.gov/gama/gamamap/public/GamaDataDisplay.asp?dataset=DHS&samp_date=&global_id=&assigned_name=3010092-077&store_num=		
GeoTracker Data:	Not Reported		

A3
ENE
0 - 1/8 Mile
Higher

CA WELLS CADDW0000014515

Well ID:	3010092-061	Well Type:	MUNICIPAL
Source:	Department of Health Services		
Other Name:	OPA WELL 03 - DESTROYED	GAMA PFAS Testing:	Not Reported
Groundwater Quality Data:	https://gamagroundwater.waterboards.ca.gov/gama/gamamap/public/GamaDataDisplay.asp?dataset=DHS&samp_date=&global_id=&assigned_name=3010092-061&store_num=		
GeoTracker Data:	Not Reported		

A4
ENE
0 - 1/8 Mile
Higher

CA WELLS CADDW0000006264

Well ID:	3010028-003	Well Type:	MUNICIPAL
Source:	Department of Health Services		
Other Name:	WELL 03 - INACTIVE	GAMA PFAS Testing:	Not Reported
Groundwater Quality Data:	https://gamagroundwater.waterboards.ca.gov/gama/gamamap/public/GamaDataDisplay.asp?dataset=DHS&samp_date=&global_id=&assigned_name=3010028-003&store_num=		
GeoTracker Data:	Not Reported		

GEOCHECK® - PHYSICAL SETTING SOURCE MAP FINDINGS

Map ID
Direction
Distance
Elevation

Database EDR ID Number

5
SE
1/8 - 1/4 Mile
Higher

CA WELLS CADWR0000008432

Well ID:	04S09W27F001S	Well Type:	UNK
Source:	Department of Water Resources		
Other Name:	04S09W27F001S	GAMA PFAS Testing:	Not Reported
Groundwater Quality Data:	https://gamagroundwater.waterboards.ca.gov/gama/gamamap/public/GamaDataDisplay.asp?dataset=DWR&samp_date=&global_id=&assigned_name=04S09W27F001S&store_num=		
GeoTracker Data:	Not Reported		

B6
NW
1/8 - 1/4 Mile
Lower

CA WELLS CADDW0000000899

Well ID:	3010028-001	Well Type:	MUNICIPAL
Source:	Department of Health Services		
Other Name:	WELL 01 - DESTROYED	GAMA PFAS Testing:	Not Reported
Groundwater Quality Data:	https://gamagroundwater.waterboards.ca.gov/gama/gamamap/public/GamaDataDisplay.asp?dataset=DHS&samp_date=&global_id=&assigned_name=3010028-001&store_num=		
GeoTracker Data:	Not Reported		

7
SW
1/8 - 1/4 Mile
Lower

CA WELLS CADWR00000032353

Well ID:	04S09W27E004S	Well Type:	UNK
Source:	Department of Water Resources		
Other Name:	04S09W27E004S	GAMA PFAS Testing:	Not Reported
Groundwater Quality Data:	https://gamagroundwater.waterboards.ca.gov/gama/gamamap/public/GamaDataDisplay.asp?dataset=DWR&samp_date=&global_id=&assigned_name=04S09W27E004S&store_num=		
GeoTracker Data:	Not Reported		

B8
NW
1/8 - 1/4 Mile
Higher

CA WELLS CADWR00000017663

Well ID:	04S09W27D001S	Well Type:	UNK
Source:	Department of Water Resources		
Other Name:	04S09W27D001S	GAMA PFAS Testing:	Not Reported
Groundwater Quality Data:	https://gamagroundwater.waterboards.ca.gov/gama/gamamap/public/GamaDataDisplay.asp?dataset=DWR&samp_date=&global_id=&assigned_name=04S09W27D001S&store_num=		
GeoTracker Data:	Not Reported		

GEOCHECK® - PHYSICAL SETTING SOURCE MAP FINDINGS

Map ID
Direction
Distance
Elevation

Database EDR ID Number

C9
West
1/8 - 1/4 Mile
Lower

CA WELLS CADWR0000007242

Well ID:	04S09W28H002S	Well Type:	UNK
Source:	Department of Water Resources		
Other Name:	04S09W28H002S	GAMA PFAS Testing:	Not Reported
Groundwater Quality Data:	https://gamagroundwater.waterboards.ca.gov/gama/gamamap/public/GamaDataDisplay.asp?dataset=DWR&samp_date=&global_id=&assigned_name=04S09W28H002S&store_num=		
GeoTracker Data:	Not Reported		

10
NNE
1/8 - 1/4 Mile
Lower

CA WELLS CADDW0000022070

Well ID:	3010027-010	Well Type:	MUNICIPAL
Source:	Department of Health Services		
Other Name:	WELL 10 - DESTROYED	GAMA PFAS Testing:	Not Reported
Groundwater Quality Data:	https://gamagroundwater.waterboards.ca.gov/gama/gamamap/public/GamaDataDisplay.asp?dataset=DHS&samp_date=&global_id=&assigned_name=3010027-010&store_num=		
GeoTracker Data:	Not Reported		

B11
NW
1/8 - 1/4 Mile
Lower

CA WELLS 5045

Seq:	5045	Prim sta c:	04S/09W-27E05 S
Frds no:	3010028002	County:	30
District:	08	User id:	TEE
System no:	3010028	Water type:	G
Source nam:	WELL 02 - DESTROYED	Station ty:	WELL/AMBNT/MUN/INTAKE/SUPPLY
Latitude:	334800.0	Longitude:	1174900.0
Precision:	8	Status:	DS
Comment 1:	Not Reported	Comment 2:	Not Reported
Comment 3:	Not Reported	Comment 4:	Not Reported
Comment 5:	Not Reported	Comment 6:	Not Reported
Comment 7:	Not Reported		

System no:	3010028	System nam:	Orange Park Acres Mwc
Hqname:	Not Reported	Address:	678 NORTH PROSPECT ST
City:	ORANGE	State:	Not Reported
Zip:	92669	Zip ext:	Not Reported
Pop serv:	1850	Connection:	505
Area serve:	ORANGE-EAST		

B12
NW
1/8 - 1/4 Mile
Lower

CA WELLS 5046

Seq:	5046	Prim sta c:	04S/09W-27E07 S
Frds no:	3010028003	County:	30

GEOCHECK® - PHYSICAL SETTING SOURCE MAP FINDINGS

District:	08	User id:	TEE
System no:	3010028	Water type:	G
Source nam:	WELL 03	Station ty:	WELL/AMBNT/MUN/INTAKE
Latitude:	334800.0	Longitude:	1174900.0
Precision:	5	Status:	AU
Comment 1:	ORANGE N/O CHAPMAN.	Comment 2:	Not Reported
Comment 3:	Not Reported	Comment 4:	Not Reported
Comment 5:	Not Reported	Comment 6:	Not Reported
Comment 7:	Not Reported		

System no:	3010028	System nam:	Orange Park Acres Mwc
Hqname:	Not Reported	Address:	678 NORTH PROSPECT ST
City:	ORANGE	State:	Not Reported
Zip:	92669	Zip ext:	Not Reported
Pop serv:	1850	Connection:	505
Area serve:	ORANGE-EAST		

**B13
NW
1/8 - 1/4 Mile
Lower**

CA WELLS 5044

Seq:	5044	Prim sta c:	04S/09W-27E04 S
Frds no:	3010028001	County:	30
District:	08	User id:	TEE
System no:	3010028	Water type:	G
Source nam:	WELL 01 - DESTROYED	Station ty:	WELL/AMBNT/MUN/INTAKE/SUPPLY
Latitude:	334800.0	Longitude:	1174900.0
Precision:	8	Status:	DS
Comment 1:	Not Reported	Comment 2:	Not Reported
Comment 3:	Not Reported	Comment 4:	Not Reported
Comment 5:	Not Reported	Comment 6:	Not Reported
Comment 7:	Not Reported		

System no:	3010028	System nam:	Orange Park Acres Mwc
Hqname:	Not Reported	Address:	678 NORTH PROSPECT ST
City:	ORANGE	State:	Not Reported
Zip:	92669	Zip ext:	Not Reported
Pop serv:	1850	Connection:	505
Area serve:	ORANGE-EAST		

**C14
West
1/8 - 1/4 Mile
Lower**

CA WELLS CADWR8000005576

State Well #:	04S09W28H002S	Station ID:	26230
Well Name:	Not Reported	Well Use:	Unknown
Well Type:	Unknown	Well Depth:	0
Basin Name:	Coastal Plain Of Orange County		
Well Completion Rpt #:	Not Reported		

GEOCHECK® - PHYSICAL SETTING SOURCE MAP FINDINGS

Map ID
Direction
Distance
Elevation

Database EDR ID Number

D15
SW
1/4 - 1/2 Mile
Lower

CA WELLS CADDW000008242

Well ID:	3010027-020	Well Type:	MUNICIPAL
Source:	Department of Health Services		
Other Name:	WELL 23	GAMA PFAS Testing:	Not Reported
Groundwater Quality Data:	https://gamagroundwater.waterboards.ca.gov/gama/gamamap/public/GamaDataDisplay.asp?dataset=DHS&samp_date=&global_id=&assigned_name=3010027-020&store_num=		
GeoTracker Data:	Not Reported		

D16
SW
1/4 - 1/2 Mile
Lower

CA WELLS CAPFAS000001375

Well ID:	3010027-020	Well Type:	MUNICIPAL
Source:	Department of Health Services		
Other Name:	WELL 23	GAMA PFAS Testing:	Yes
Groundwater Quality Data:	https://gamagroundwater.waterboards.ca.gov/gama/gamamap/public/GamaDataDisplay.asp?dataset=DHS&samp_date=&global_id=&assigned_name=3010027-020&store_num=		
GeoTracker Data:	Not Reported		

17
SW
1/4 - 1/2 Mile
Lower

CA WELLS 5048

Seq:	5048	Prim sta c:	04S/09W-28J02 S
Frds no:	3010027020	County:	30
District:	08	User id:	TEE
System no:	3010027	Water type:	G
Source nam:	WELL 23	Station ty:	WELL/AMBNT/MUN/INTAKE/SUPPLY
Latitude:	334738.0	Longitude:	1174909.0
Precision:	5	Status:	AU
Comment 1:	LOCATED ALONG EAST SIDE OF SANTIAGO CR. ~ 250' WEST OF WALNUT AVE.		
Comment 2:	Not Reported	Comment 3:	Not Reported
Comment 4:	Not Reported	Comment 5:	Not Reported
Comment 6:	Not Reported	Comment 7:	Not Reported

System no:	3010027	System nam:	City Of Orange
Hqname:	Not Reported	Address:	P O BOX 449
City:	ORANGE	State:	Not Reported
Zip:	92666	Zip ext:	Not Reported
Pop serv:	116800	Connection:	30144
Area serve:	ORANGE		

Sample date:	06-MAR-18	Finding:	3.39
Chemical:	NITRATE (AS N)	Report units:	MG/L
Dir:	0.4		

Sample date:	06-MAR-18	Finding:	3.39
Chemical:	NITRATE + NITRITE (AS N)	Report units:	MG/L
Dir:	0.4		

GEOCHECK® - PHYSICAL SETTING SOURCE MAP FINDINGS

Sample date:	16-JAN-17	Finding:	3.33
Chemical:	NITRATE + NITRITE (AS N)	Report units:	MG/L
Dir:	0.4		
Sample date:	16-JAN-17	Finding:	3.33
Chemical:	NITRATE (AS N)	Report units:	MG/L
Dir:	0.4		
Sample date:	14-APR-16	Finding:	881.
Chemical:	SPECIFIC CONDUCTANCE	Report units:	US
Dir:	0.		
Sample date:	14-APR-16	Finding:	7.7
Chemical:	PH, LABORATORY	Report units:	Not Reported
Dir:	0.		
Sample date:	14-APR-16	Finding:	186.
Chemical:	ALKALINITY (TOTAL) AS CaCO ₃	Report units:	MG/L
Dir:	0.		
Sample date:	14-APR-16	Finding:	186.
Chemical:	BICARBONATE ALKALINITY	Report units:	MG/L
Dir:	0.		
Sample date:	14-APR-16	Finding:	2.11
Chemical:	NITRATE (AS N)	Report units:	MG/L
Dir:	0.4		
Sample date:	14-APR-16	Finding:	0.42
Chemical:	TOTAL ORGANIC CARBON (TOC)	Report units:	MG/L
Dir:	0.3		
Sample date:	14-APR-16	Finding:	330.
Chemical:	HARDNESS (TOTAL) AS CaCO ₃	Report units:	MG/L
Dir:	0.		
Sample date:	14-APR-16	Finding:	94.1
Chemical:	CALCIUM	Report units:	MG/L
Dir:	0.		
Sample date:	14-APR-16	Finding:	23.
Chemical:	MAGNESIUM	Report units:	MG/L
Dir:	0.		
Sample date:	14-APR-16	Finding:	58.3
Chemical:	SODIUM	Report units:	MG/L
Dir:	0.		
Sample date:	14-APR-16	Finding:	2.
Chemical:	POTASSIUM	Report units:	MG/L
Dir:	0.		
Sample date:	14-APR-16	Finding:	99.
Chemical:	CHLORIDE	Report units:	MG/L
Dir:	0.		
Sample date:	14-APR-16	Finding:	137.
Chemical:	SULFATE	Report units:	MG/L
Dir:	0.5		
Sample date:	14-APR-16	Finding:	0.17
Chemical:	FLUORIDE (F) (NATURAL-SOURCE)	Report units:	MG/L

GEOCHECK® - PHYSICAL SETTING SOURCE MAP FINDINGS

Dir:	0.1		
Sample date:	14-APR-16	Finding:	110.
Chemical:	BORON	Report units:	UG/L
Dir:	100.		
Sample date:	14-APR-16	Finding:	566.
Chemical:	TOTAL DISSOLVED SOLIDS	Report units:	MG/L
Dir:	0.		
Sample date:	14-APR-16	Finding:	0.25
Chemical:	TOTAL TRIHALOMETHANES	Report units:	UG/L
Dir:	0.		
Sample date:	14-APR-16	Finding:	0.2
Chemical:	BROMIDE	Report units:	MG/L
Dir:	0.		
Sample date:	14-APR-16	Finding:	2.12
Chemical:	NITRATE + NITRITE (AS N)	Report units:	MG/L
Dir:	0.4		
Sample date:	28-SEP-15	Finding:	0.7
Chemical:	TOTAL TRIHALOMETHANES	Report units:	UG/L
Dir:	0.		
Sample date:	28-SEP-15	Finding:	2080.
Chemical:	NITRATE + NITRITE (AS N)	Report units:	MG/L
Dir:	0.4		
Sample date:	28-SEP-15	Finding:	9.2
Chemical:	NITRATE (AS NO3)	Report units:	MG/L
Dir:	2.		
Sample date:	19-NOV-14	Finding:	0.9
Chemical:	TOTAL TRIHALOMETHANES	Report units:	UG/L
Dir:	0.		
Sample date:	19-NOV-14	Finding:	0.9
Chemical:	TOTAL TRIHALOMETHANES	Report units:	UG/L
Dir:	0.		
Sample date:	14-OCT-14	Finding:	0.25
Chemical:	TOTAL TRIHALOMETHANES	Report units:	UG/L
Dir:	0.		
Sample date:	14-OCT-14	Finding:	2370.
Chemical:	NITRATE + NITRITE (AS N)	Report units:	MG/L
Dir:	0.4		
Sample date:	27-AUG-14	Finding:	3620.
Chemical:	NITRATE + NITRITE (AS N)	Report units:	MG/L
Dir:	0.4		
Sample date:	13-MAY-14	Finding:	3450.
Chemical:	NITRATE + NITRITE (AS N)	Report units:	MG/L
Dir:	0.4		
Sample date:	13-MAR-14	Finding:	0.66
Chemical:	URANIUM COUNTING ERROR	Report units:	PCI/L
Dir:	0.		

GEOCHECK® - PHYSICAL SETTING SOURCE MAP FINDINGS

Sample date:	13-MAR-14	Finding:	1.11
Chemical:	GROSS ALPHA MDA95	Report units:	PCI/L
Dir:	0.		
Sample date:	13-MAR-14	Finding:	0.3
Chemical:	URANIUM MDA95	Report units:	PCI/L
Dir:	0.		
Sample date:	13-MAR-14	Finding:	0.253
Chemical:	RADIUM 228 MDA95	Report units:	PCI/L
Dir:	0.		
Sample date:	13-MAR-14	Finding:	0.119
Chemical:	RA-226 FOR CWS OR TOTAL RA FOR NTNC BY 903.0	Dir:	0.
Report units:	PCI/L		
Sample date:	13-MAR-14	Finding:	0.174
Chemical:	RA-226 OR TOTAL RA BY 903.0 C.E.	Report units:	PCI/L
Dir:	0.		
Sample date:	13-MAR-14	Finding:	0.418
Chemical:	RADIUM, TOTAL, MDA95-NTNC ONLY, BY 903.0	Dir:	0.
Report units:	PCI/L		
Sample date:	13-MAR-14	Finding:	3500.
Chemical:	NITRATE + NITRITE (AS N)	Report units:	MG/L
Dir:	0.4		
Sample date:	13-MAR-14	Finding:	1.16
Chemical:	GROSS ALPHA COUNTING ERROR	Report units:	PCI/L
Dir:	0.		
Sample date:	13-MAR-14	Finding:	0.436
Chemical:	RADIUM 228 COUNTING ERROR	Report units:	PCI/L
Dir:	0.		
Sample date:	06-NOV-13	Finding:	3670.
Chemical:	NITRATE + NITRITE (AS N)	Report units:	MG/L
Dir:	0.4		
Sample date:	26-AUG-13	Finding:	57.2
Chemical:	SODIUM	Report units:	MG/L
Dir:	0.		
Sample date:	26-AUG-13	Finding:	3760.
Chemical:	NITRATE + NITRITE (AS N)	Report units:	MG/L
Dir:	0.4		
Sample date:	26-AUG-13	Finding:	0.24
Chemical:	BROMIDE	Report units:	MG/L
Dir:	0.		
Sample date:	26-AUG-13	Finding:	0.2
Chemical:	TURBIDITY, LABORATORY	Report units:	NTU
Dir:	0.1		
Sample date:	26-AUG-13	Finding:	1010.
Chemical:	SPECIFIC CONDUCTANCE	Report units:	US
Dir:	0.		
Sample date:	26-AUG-13	Finding:	7.8
Chemical:	PH, LABORATORY	Report units:	Not Reported

GEOCHECK® - PHYSICAL SETTING SOURCE MAP FINDINGS

Dir:	0.		
Sample date:	26-AUG-13	Finding:	184.
Chemical:	ALKALINITY (TOTAL) AS CaCO3	Report units:	MG/L
Dir:	0.		
Sample date:	26-AUG-13	Finding:	225.
Chemical:	BICARBONATE ALKALINITY	Report units:	MG/L
Dir:	0.		
Sample date:	26-AUG-13	Finding:	0.53
Chemical:	TOTAL ORGANIC CARBON (TOC)	Report units:	MG/L
Dir:	0.3		
Sample date:	26-AUG-13	Finding:	354.
Chemical:	HARDNESS (TOTAL) AS CaCO3	Report units:	MG/L
Dir:	0.		
Sample date:	26-AUG-13	Finding:	102.
Chemical:	CALCIUM	Report units:	MG/L
Dir:	0.		
Sample date:	26-AUG-13	Finding:	24.
Chemical:	MAGNESIUM	Report units:	MG/L
Dir:	0.		
Sample date:	26-AUG-13	Finding:	2.
Chemical:	POTASSIUM	Report units:	MG/L
Dir:	0.		
Sample date:	26-AUG-13	Finding:	96.8
Chemical:	CHLORIDE	Report units:	MG/L
Dir:	0.		
Sample date:	26-AUG-13	Finding:	135.
Chemical:	SULFATE	Report units:	MG/L
Dir:	0.5		
Sample date:	26-AUG-13	Finding:	0.14
Chemical:	FLUORIDE (F) (NATURAL-SOURCE)	Report units:	MG/L
Dir:	0.1		
Sample date:	26-AUG-13	Finding:	110.
Chemical:	BORON	Report units:	UG/L
Dir:	100.		
Sample date:	26-AUG-13	Finding:	608.
Chemical:	TOTAL DISSOLVED SOLIDS	Report units:	MG/L
Dir:	0.		
Sample date:	21-MAY-13	Finding:	3860.
Chemical:	NITRATE + NITRITE (AS N)	Report units:	MG/L
Dir:	0.4		
Sample date:	06-MAR-13	Finding:	3800.
Chemical:	NITRATE + NITRITE (AS N)	Report units:	MG/L
Dir:	0.4		
Sample date:	27-NOV-12	Finding:	3630.
Chemical:	NITRATE + NITRITE (AS N)	Report units:	MG/L
Dir:	0.4		

GEOCHECK® - PHYSICAL SETTING SOURCE MAP FINDINGS

Sample date:	27-FEB-12	Finding:	3890.
Chemical:	NITRATE + NITRITE (AS N)	Report units:	MG/L
Dir:	0.4		

**E18
WNW
1/4 - 1/2 Mile
Higher**

CA WELLS CAPFAS000001325

Well ID:	3010027-022	Well Type:	MUNICIPAL
Source:	Department of Health Services		
Other Name:	WELL 24	GAMA PFAS Testing:	Yes
Groundwater Quality Data:	https://gamagroundwater.waterboards.ca.gov/gama/gamamap/public/GamaDataDisplay.asp?dataset=DHS&samp_date=&global_id=&assigned_name=3010027-022&store_num=		
GeoTracker Data:	Not Reported		

**E19
WNW
1/4 - 1/2 Mile
Higher**

CA WELLS CADDW0000012501

Well ID:	3010027-022	Well Type:	MUNICIPAL
Source:	Department of Health Services		
Other Name:	WELL 24	GAMA PFAS Testing:	Not Reported
Groundwater Quality Data:	https://gamagroundwater.waterboards.ca.gov/gama/gamamap/public/GamaDataDisplay.asp?dataset=DHS&samp_date=&global_id=&assigned_name=3010027-022&store_num=		
GeoTracker Data:	Not Reported		

**E20
WNW
1/4 - 1/2 Mile
Lower**

CA WELLS CAUSGSN00011008

Well ID:	USGS-334806117492001	Well Type:	UNK
Source:	United States Geological Survey		
Other Name:	USGS-334806117492001	GAMA PFAS Testing:	Not Reported
Groundwater Quality Data:	https://gamagroundwater.waterboards.ca.gov/gama/gamamap/public/GamaDataDisplay.asp?dataset=USGSNEW&samp_date=&global_id=&assigned_name=USGS-334806117492001&store_num=		
GeoTracker Data:	Not Reported		

**E21
WNW
1/4 - 1/2 Mile
Lower**

CA WELLS CALLNL000001292

Well ID:	100719	Well Type:	MUNICIPAL
Source:	Lawrence Livermore National Laboratory		
Other Name:	04S/09W-28A01 S	GAMA PFAS Testing:	Not Reported
Groundwater Quality Data:	Not Reported		
GeoTracker Data:	Not Reported		

Chemical:	Krypton	Results:	.000000105682
Units:	cm3STP/g	Date:	09/06/2001

GEOCHECK® - PHYSICAL SETTING SOURCE MAP FINDINGS

Chemical:	Argon	Results:	.000494265
Units:	cm3STP/g	Date:	09/06/2001
Chemical:	Tritium (Hydrogen 3)	Results:	13.62
Units:	pCi/L	Date:	10/10/2001
Chemical:	Helium-4	Results:	.000000220366
Units:	cm3STP/g	Date:	09/06/2001
Chemical:	Neon	Results:	.000000748216
Units:	cm3STP/g	Date:	09/06/2001
Chemical:	Xenon	Results:	.0000000830167
Units:	cm3STP/g	Date:	09/06/2001
Chemical:	Helium-3/Helium-4	Results:	.00000151179
Units:	atom ratio	Date:	09/06/2001

**E22
WNW
1/4 - 1/2 Mile
Lower**

FED USGS USGS40000138296

Organization ID:	USGS-CA		
Organization Name:	USGS California Water Science Center		
Monitor Location:	004S009W28A001S	Type:	Well
Description:	Not Reported	HUC:	Not Reported
Drainage Area:	Not Reported	Drainage Area Units:	Not Reported
Contrib Drainage Area:	Not Reported	Contrib Drainage Area Units:	Not Reported
Aquifer:	California Coastal Basin aquifers		
Formation Type:	Not Reported	Aquifer Type:	Not Reported
Construction Date:	19940425	Well Depth:	820
Well Depth Units:	ft	Well Hole Depth:	826
Well Hole Depth Units:	ft		

Ground water levels,Number of Measurements:	1	Level reading date:	1994-05-05
Feet below surface:	191	Feet to sea level:	Not Reported
Note:	Other conditions existed that would affect the measured water level.		

**23
SW
1/2 - 1 Mile
Lower**

CA WELLS CADWR0000027580

Well ID:	04S09W28J001S	Well Type:	UNK
Source:	Department of Water Resources		
Other Name:	04S09W28J001S	GAMA PFAS Testing:	Not Reported
Groundwater Quality Data:	https://gamagroundwater.waterboards.ca.gov/gama/gamamap/public/GamaDataDisplay.asp?dataset=DWR&samp_date=&global_id=&assigned_name=04S09W28J001S&store_num=		
GeoTracker Data:	Not Reported		

GEOCHECK® - PHYSICAL SETTING SOURCE MAP FINDINGS

Map ID
Direction
Distance
Elevation

Database EDR ID Number

F24
NE
1/2 - 1 Mile
Higher

CA WELLS CADWR8000005616

State Well #:	04S09W22Q002S	Station ID:	47351
Well Name:	SCS-2/MP1	Well Use:	Observation
Well Type:	Part of a nested/multi-completion well		
Well Depth:	375	Basin Name:	Coastal Plain Of Orange County
Well Completion Rpt #:	255947		

F25
NE
1/2 - 1 Mile
Higher

CA WELLS CADWR8000005617

State Well #:	Not Reported	Station ID:	47352
Well Name:	SCS-2/MP5	Well Use:	Observation
Well Type:	Part of a nested/multi-completion well		
Well Depth:	375	Basin Name:	Coastal Plain Of Orange County
Well Completion Rpt #:	255947		

G26
North
1/2 - 1 Mile
Higher

CA WELLS CADWR8000005634

State Well #:	04S09W22M002S	Station ID:	3602
Well Name:	Not Reported	Well Use:	Unknown
Well Type:	Unknown	Well Depth:	0
Basin Name:	Coastal Plain Of Orange County		
Well Completion Rpt #:	Not Reported		

H27
SSW
1/2 - 1 Mile
Lower

CA WELLS CADWR0000014458

Well ID:	04S09W28R002S	Well Type:	UNK
Source:	Department of Water Resources		
Other Name:	04S09W28R002S	GAMA PFAS Testing:	Not Reported
Groundwater Quality Data:	https://gamagroundwater.waterboards.ca.gov/gama/gamamap/public/GamaDataDisplay.asp?dataset=DWR&samp_date=&global_id=&assigned_name=04S09W28R002S&store_num=		
GeoTracker Data:	Not Reported		

G28
North
1/2 - 1 Mile
Higher

CA WELLS CADWR0000015617

Well ID:	04S09W22M002S	Well Type:	UNK
Source:	Department of Water Resources		

GEOCHECK® - PHYSICAL SETTING SOURCE MAP FINDINGS

Other Name:	04S09W22M002S	GAMA PFAS Testing:	Not Reported
Groundwater Quality Data:	https://gamagroundwater.waterboards.ca.gov/gama/gamamap/public/GamaDataDisplay.asp?dataset=DWR&samp_date=&global_id=&assigned_name=04S09W22M002S&store_num=		
GeoTracker Data:	Not Reported		

**H29
SSW
1/2 - 1 Mile
Lower**

CA WELLS CAPFAS000001364

Well ID:	3010068-001	Well Type:	MUNICIPAL
Source:	Department of Health Services		
Other Name:	EAST WELL		
Groundwater Quality Data:	https://gamagroundwater.waterboards.ca.gov/gama/gamamap/public/GamaDataDisplay.asp?dataset=DHS&samp_date=&global_id=&assigned_name=3010068-001&store_num=		
GeoTracker Data:	Not Reported		

**H30
SSW
1/2 - 1 Mile
Lower**

CA WELLS CADDW0000001063

Well ID:	3010068-001	Well Type:	MUNICIPAL
Source:	Department of Health Services		
Other Name:	EAST WELL		
Groundwater Quality Data:	https://gamagroundwater.waterboards.ca.gov/gama/gamamap/public/GamaDataDisplay.asp?dataset=DHS&samp_date=&global_id=&assigned_name=3010068-001&store_num=		
GeoTracker Data:	Not Reported		

**H31
SSW
1/2 - 1 Mile
Lower**

CA WELLS CAPFAS000000722

Well ID:	3010068-002	Well Type:	MUNICIPAL
Source:	Department of Health Services		
Other Name:	WEST WELL		
Groundwater Quality Data:	https://gamagroundwater.waterboards.ca.gov/gama/gamamap/public/GamaDataDisplay.asp?dataset=DHS&samp_date=&global_id=&assigned_name=3010068-002&store_num=		
GeoTracker Data:	Not Reported		

**H32
SSW
1/2 - 1 Mile
Lower**

CA WELLS CADDW0000006265

Well ID:	3010068-002	Well Type:	MUNICIPAL
Source:	Department of Health Services		
Other Name:	WEST WELL		
Groundwater Quality Data:	https://gamagroundwater.waterboards.ca.gov/gama/gamamap/public/GamaDataDisplay.asp?dataset=DHS&samp_date=&global_id=&assigned_name=3010068-002&store_num=		
GeoTracker Data:	Not Reported		

GEOCHECK® - PHYSICAL SETTING SOURCE MAP FINDINGS

Map ID
 Direction
 Distance
 Elevation

Database EDR ID Number

H33
SW
 1/2 - 1 Mile
 Lower

FED USGS USGS40000138191

Organization ID:	USGS-CA	Type:	Well
Organization Name:	USGS California Water Science Center	HUC:	Not Reported
Monitor Location:	004S009W28R002S	Drainage Area Units:	Not Reported
Description:	Not Reported	Contrib Drainage Area Unts:	Not Reported
Drainage Area:	Not Reported	Aquifer Type:	Unconfined single aquifer
Contrib Drainage Area:	Not Reported	Well Depth:	504
Aquifer:	California Coastal Basin aquifers	Well Hole Depth:	504
Formation Type:	Not Reported		
Construction Date:	Not Reported		
Well Depth Units:	ft		
Well Hole Depth Units:	ft		

Ground water levels,Number of Measurements:	1	Level reading date:	2000-10-23
Feet below surface:	249	Feet to sea level:	Not Reported
Note:	Not Reported		

H34
SW
 1/2 - 1 Mile
 Lower

CA WELLS CAUSGSN00014090

Well ID:	USGS-334722117491901	Well Type:	UNK
Source:	United States Geological Survey		
Other Name:	USGS-334722117491901	GAMA PFAS Testing:	Not Reported
Groundwater Quality Data:	https://gamagroundwater.waterboards.ca.gov/gama/gamamap/public/GamaDataDisplay.asp?dataset=USGSNEW&amp_date=&global_id=&assigned_name=USGS-334722117491901&store_num=		
GeoTracker Data:	Not Reported		

H35
SW
 1/2 - 1 Mile
 Lower

CA WELLS CALLNL000000939

Well ID:	101123	Well Type:	MUNICIPAL
Source:	Lawrence Livermore National Laboratory		
Other Name:	04S/09W-28R02 S	GAMA PFAS Testing:	Not Reported
Groundwater Quality Data:	Not Reported		
GeoTracker Data:	Not Reported		

Chemical:	Argon	Results:	.000542288
Units:	cm3STP/g	Date:	04/03/2002

Chemical:	Helium-3/Helium-4	Results:	.00000176855
Units:	atom ratio	Date:	04/03/2002

Chemical:	Tritium (Hydrogen 3)	Results:	14.29
Units:	pCi/L	Date:	04/15/2002

GEOCHECK® - PHYSICAL SETTING SOURCE MAP FINDINGS

Chemical:	Helium-4	Results:	.00000016258
Units:	cm3STP/g	Date:	04/03/2002

**H36
SW
1/2 - 1 Mile
Lower**

CA WELLS CALLNL000001116

Well ID:	100651	Well Type:	MUNICIPAL
Source:	Lawrence Livermore National Laboratory		
Other Name:	04S/09W-28R02 S	GAMA PFAS Testing:	Not Reported
Groundwater Quality Data:	Not Reported		
GeoTracker Data:	Not Reported		

Chemical:	Helium-3/Helium-4	Results:	.00000165559
Units:	atom ratio	Date:	10/19/2001

Chemical:	Helium-4	Results:	.000000179913
Units:	cm3STP/g	Date:	10/19/2001

Chemical:	Neon	Results:	.000000584625
Units:	cm3STP/g	Date:	10/19/2001

Chemical:	Tritium (Hydrogen 3)	Results:	14.01
Units:	pCi/L	Date:	08/30/2001

Chemical:	Argon	Results:	.000494967
Units:	cm3STP/g	Date:	10/19/2001

**H37
SW
1/2 - 1 Mile
Lower**

CA WELLS CADWR0000035928

Well ID:	04S09W28R001S	Well Type:	UNK
Source:	Department of Water Resources		
Other Name:	04S09W28R001S	GAMA PFAS Testing:	Not Reported
Groundwater Quality Data:	https://gamagroundwater.waterboards.ca.gov/gama/gamamap/public/GamaDataDisplay.asp?dataset=DWR&samp_date=&global_id=&assigned_name=04S09W28R001S&store_num=		
GeoTracker Data:	Not Reported		

**H38
SW
1/2 - 1 Mile
Lower**

FED USGS USGS40000138190

Organization ID:	USGS-CA		
Organization Name:	USGS California Water Science Center		
Monitor Location:	004S009W28R001S	Type:	Well
Description:	Not Reported	HUC:	18070106
Drainage Area:	Not Reported	Drainage Area Units:	Not Reported

GEOCHECK® - PHYSICAL SETTING SOURCE MAP FINDINGS

Contrib Drainage Area:	Not Reported	Contrib Drainage Area Unts:	Not Reported
Aquifer:	California Coastal Basin aquifers	Aquifer Type:	Not Reported
Formation Type:	Not Reported	Well Depth:	Not Reported
Construction Date:	19260101	Well Hole Depth:	800
Well Depth Units:	Not Reported		
Well Hole Depth Units:	ft		

Ground water levels, Number of Measurements:	39	Level reading date:	1986-08-29
Feet below surface:	243.89	Feet to sea level:	Not Reported
Note:	Not Reported		

Level reading date:	1986-05-06	Feet below surface:	236.50
Feet to sea level:	Not Reported	Note:	Not Reported

Level reading date:	1986-02-11	Feet below surface:	229.49
Feet to sea level:	Not Reported	Note:	Not Reported

Level reading date:	1985-11-06	Feet below surface:	237.08
Feet to sea level:	Not Reported	Note:	Not Reported

Level reading date:	1985-08-22	Feet below surface:	242.45
Feet to sea level:	Not Reported		
Note:	A nearby site that taps the same aquifer was being pumped.		

Level reading date:	1985-05-09	Feet below surface:	225.69
Feet to sea level:	Not Reported	Note:	Not Reported

Level reading date:	1985-02-13	Feet below surface:	219.40
Feet to sea level:	Not Reported		
Note:	A nearby site that taps the same aquifer had been pumped recently.		

Level reading date:	1984-10-30	Feet below surface:	232.75
Feet to sea level:	Not Reported		
Note:	A nearby site that taps the same aquifer was being pumped.		

Level reading date:	1984-08-30	Feet below surface:	231.52
Feet to sea level:	Not Reported		
Note:	A nearby site that taps the same aquifer was being pumped.		

Level reading date:	1984-05-18	Feet below surface:	208.32
Feet to sea level:	Not Reported	Note:	Not Reported

Level reading date:	1984-02-15	Feet below surface:	201.30
Feet to sea level:	Not Reported	Note:	Not Reported

Level reading date:	1983-11-02	Feet below surface:	195.72
Feet to sea level:	Not Reported	Note:	Not Reported

Level reading date:	1983-08-12	Feet below surface:	204.06
Feet to sea level:	Not Reported		
Note:	A nearby site that taps the same aquifer was being pumped.		

Level reading date:	1983-05-11	Feet below surface:	201.42
Feet to sea level:	Not Reported		
Note:	A nearby site that taps the same aquifer was being pumped.		

Level reading date:	1983-02-09	Feet below surface:	232.09
Feet to sea level:	Not Reported		
Note:	A nearby site that taps the same aquifer had been pumped recently.		

Level reading date:	1982-11-04	Feet below surface:	232.60
---------------------	------------	---------------------	--------

GEOCHECK® - PHYSICAL SETTING SOURCE MAP FINDINGS

Feet to sea level:	Not Reported	Note:	Not Reported
Level reading date:	1982-07-28	Feet below surface:	229.89
Feet to sea level:	Not Reported		
Note:	A nearby site that taps the same aquifer had been pumped recently.		
Level reading date:	1982-04-29	Feet below surface:	221.26
Feet to sea level:	Not Reported	Note:	Not Reported
Level reading date:	1982-01-25	Feet below surface:	222.75
Feet to sea level:	Not Reported	Note:	Not Reported
Level reading date:	1981-11-04	Feet below surface:	233.25
Feet to sea level:	Not Reported	Note:	Not Reported
Level reading date:	1981-07-30	Feet below surface:	218.41
Feet to sea level:	Not Reported	Note:	Not Reported
Level reading date:	1981-02-05	Feet below surface:	199.32
Feet to sea level:	Not Reported	Note:	Not Reported
Level reading date:	1980-10-28	Feet below surface:	199.49
Feet to sea level:	Not Reported	Note:	Not Reported
Level reading date:	1980-08-29	Feet below surface:	180.54
Feet to sea level:	Not Reported	Note:	Not Reported
Level reading date:	1979-11-14	Feet below surface:	236.17
Feet to sea level:	Not Reported	Note:	Not Reported
Level reading date:	1979-05-01	Feet below surface:	215.97
Feet to sea level:	Not Reported	Note:	Not Reported
Level reading date:	1977-10-28	Feet below surface:	271.61
Feet to sea level:	Not Reported	Note:	Not Reported
Level reading date:	1977-03-10	Feet below surface:	259.10
Feet to sea level:	Not Reported	Note:	Not Reported
Level reading date:	1976-05-04	Feet below surface:	249.60
Feet to sea level:	Not Reported	Note:	Not Reported
Level reading date:	1976-03-08	Feet below surface:	253.60
Feet to sea level:	Not Reported	Note:	Not Reported
Level reading date:	1975-11-24	Feet below surface:	256.10
Feet to sea level:	Not Reported	Note:	Not Reported
Level reading date:	1972-07-06	Feet below surface:	258.50
Feet to sea level:	Not Reported	Note:	Not Reported
Level reading date:	1972-02-29	Feet below surface:	241.00
Feet to sea level:	Not Reported	Note:	Not Reported
Level reading date:	1971-04-30	Feet below surface:	218.50
Feet to sea level:	Not Reported	Note:	Not Reported
Level reading date:	1971-04-08	Feet below surface:	225.10
Feet to sea level:	Not Reported	Note:	Not Reported
Level reading date:	1971-03-02	Feet below surface:	219.80
Feet to sea level:	Not Reported	Note:	Not Reported

GEOCHECK® - PHYSICAL SETTING SOURCE MAP FINDINGS

Level reading date:	1970-12-10	Feet below surface:	219.50
Feet to sea level:	Not Reported	Note:	Not Reported
Level reading date:	1970-11-02	Feet below surface:	220.50
Feet to sea level:	Not Reported	Note:	Not Reported
Level reading date:	1970-10-05	Feet below surface:	218.60
Feet to sea level:	Not Reported	Note:	Not Reported

39 SSW 1/2 - 1 Mile Lower	Site ID: 083002014T		AQUIFLOW 68248
	Groundwater Flow: NW		
	Shallow Water Depth: 21.19		
	Deep Water Depth: 37.97		
	Average Water Depth: Not Reported		
	Date: 12/31/1998		

G40 North 1/2 - 1 Mile Higher			CA WELLS CADWR8000005637
State Well #:	04S09W22M003S	Station ID:	3603
Well Name:	Not Reported	Well Use:	Unknown
Well Type:	Unknown	Well Depth:	0
Basin Name:	Coastal Plain Of Orange County		
Well Completion Rpt #:	Not Reported		

I41 SSE 1/2 - 1 Mile Lower			CA WELLS CAEDF0000118625
Well ID:	T0605901353-MW-4	Well Type:	MONITORING
Source:	EDF	Other Name:	MW-4
GAMA PFAS Testing:	Not Reported		
Groundwater Quality Data:	https://gamagroundwater.waterboards.ca.gov/gama/gamamap/public/GamaDataDisplay.asp?dataset=EDF&samp_date=&global_id=T0605901353&assigned_name=MW-4&store_num=		
GeoTracker Data:	https://geotracker.waterboards.ca.gov/profile_report.asp?cmd=MWEDFResults&global_id=T0605901353&assigned_name=MW-4		

I42 SSE 1/2 - 1 Mile Lower			CA WELLS CAEDF0000114811
Well ID:	T0605901353-MW-1	Well Type:	MONITORING
Source:	EDF	Other Name:	MW-1
GAMA PFAS Testing:	Not Reported		
Groundwater Quality Data:	https://gamagroundwater.waterboards.ca.gov/gama/gamamap/public/GamaDataDisplay.asp?dataset=EDF&samp_date=&global_id=T0605901353&assigned_name=MW-1&store_num=		
GeoTracker Data:	https://geotracker.waterboards.ca.gov/profile_report.asp?cmd=MWEDFResults&global_id=T0605901353&assigned_name=MW-1		

GEOCHECK® - PHYSICAL SETTING SOURCE MAP FINDINGS

Map ID
Direction
Distance
Elevation

Database EDR ID Number

I43
SSE
1/2 - 1 Mile
Lower

CA WELLS CAEDF0000110342

Well ID:	T0605901353-MW-2	Well Type:	MONITORING
Source:	EDF	Other Name:	MW-2
GAMA PFAS Testing:	Not Reported		
Groundwater Quality Data:	https://gamagroundwater.waterboards.ca.gov/gama/gamamap/public/GamaDataDisplay.asp?dataset=EDF&samp_date=&global_id=T0605901353&assigned_name=MW-2&store_num=		
GeoTracker Data:	https://geotracker.waterboards.ca.gov/profile_report.asp?cmd=MWEDFResults&global_id=T0605901353&assigned_name=MW-2		

44
SE
1/2 - 1 Mile
Higher

CA WELLS CADPR0000000041

Well ID:	79763	Well Type:	UNK
Source:	Department of Pesticide Regulation		
Other Name:	79763	GAMA PFAS Testing:	Not Reported
Groundwater Quality Data:	https://gamagroundwater.waterboards.ca.gov/gama/gamamap/public/GamaDataDisplay.asp?dataset=DPR&samp_date=&global_id=&assigned_name=79763&store_num=		
GeoTracker Data:	Not Reported		

J45
NNW
1/2 - 1 Mile
Higher

CA WELLS CAPFAS0000000542

Well ID:	3010082-005	Well Type:	MUNICIPAL
Source:	Department of Health Services		
Other Name:	WELL 03 009	GAMA PFAS Testing:	Yes
Groundwater Quality Data:	https://gamagroundwater.waterboards.ca.gov/gama/gamamap/public/GamaDataDisplay.asp?dataset=DHS&samp_date=&global_id=&assigned_name=3010082-005&store_num=		
GeoTracker Data:	Not Reported		

J46
NNW
1/2 - 1 Mile
Higher

CA WELLS CADDW0000011800

Well ID:	3010082-005	Well Type:	MUNICIPAL
Source:	Department of Health Services		
Other Name:	WELL 03 009	GAMA PFAS Testing:	Not Reported
Groundwater Quality Data:	https://gamagroundwater.waterboards.ca.gov/gama/gamamap/public/GamaDataDisplay.asp?dataset=DHS&samp_date=&global_id=&assigned_name=3010082-005&store_num=		
GeoTracker Data:	Not Reported		

GEOCHECK® - PHYSICAL SETTING SOURCE MAP FINDINGS

Map ID
Direction
Distance
Elevation

Database EDR ID Number

J47
NNW
1/2 - 1 Mile
Higher

CA WELLS CAUSGS000002258

Well ID:	CLABOC-24	Well Type:	MUNICIPAL
Source:	United States Geological Survey		
Other Name:	CLABOC-24	GAMA PFAS Testing:	Not Reported
Groundwater Quality Data:	https://gamagroundwater.waterboards.ca.gov/gama/gamamap/public/GamaDataDisplay.asp?dataset=USGS&samp_date=&global_id=&assigned_name=CLABOC-24&store_num=		
GeoTracker Data:	Not Reported		

J48
NNW
1/2 - 1 Mile
Higher

CA WELLS CAUSGSN00003132

Well ID:	USGS-334833117490301	Well Type:	UNK
Source:	United States Geological Survey		
Other Name:	USGS-334833117490301	GAMA PFAS Testing:	Not Reported
Groundwater Quality Data:	https://gamagroundwater.waterboards.ca.gov/gama/gamamap/public/GamaDataDisplay.asp?dataset=USGSNEW&samp_date=&global_id=&assigned_name=USGS-334833117490301&store_num=		
GeoTracker Data:	Not Reported		

J49
NNW
1/2 - 1 Mile
Higher

FED USGS USGS40000138359

Organization ID:	USGS-CA		
Organization Name:	USGS California Water Science Center		
Monitor Location:	004S009W22M001S	Type:	Well
Description:	Not Reported	HUC:	18070203
Drainage Area:	Not Reported	Drainage Area Units:	Not Reported
Contrib Drainage Area:	Not Reported	Contrib Drainage Area Unts:	Not Reported
Aquifer:	California Coastal Basin aquifers		
Formation Type:	Alluvium	Aquifer Type:	Unconfined single aquifer
Construction Date:	19200101	Well Depth:	604
Well Depth Units:	ft	Well Hole Depth:	604
Well Hole Depth Units:	ft		

Ground water levels,Number of Measurements:	2	Level reading date:	2004-03-31
Feet below surface:	285	Feet to sea level:	Not Reported
Note:	Not Reported		
Level reading date:	1999-03-29	Feet below surface:	233.17
Feet to sea level:	Not Reported	Note:	Not Reported

GEOCHECK® - PHYSICAL SETTING SOURCE MAP FINDINGS

Map ID
Direction
Distance
Elevation

Database EDR ID Number

50
WSW
1/2 - 1 Mile
Lower

CA WELLS CADWR0000028779

Well ID:	04S09W28X001S	Well Type:	UNK
Source:	Department of Water Resources		
Other Name:	04S09W28X001S	GAMA PFAS Testing:	Not Reported
Groundwater Quality Data:	https://gamagroundwater.waterboards.ca.gov/gama/gamamap/public/GamaDataDisplay.asp?dataset=DWR&samp_date=&global_id=&assigned_name=04S09W28X001S&store_num=		
GeoTracker Data:	Not Reported		

51
East
1/2 - 1 Mile
Higher

CA WELLS 5043

Seq:	5043	Prim sta c:	04S/09W-27C01 S
Frds no:	3010027010	County:	30
District:	08	User id:	TEE
System no:	3010027	Water type:	G
Source nam:	WELL 10	Station ty:	WELL/AMBNT/MUN/INTAKE/SUPPLY
Latitude:	334800.0	Longitude:	1174800.0
Precision:	8	Status:	AU
Comment 1:	Not Reported	Comment 2:	Not Reported
Comment 3:	Not Reported	Comment 4:	Not Reported
Comment 5:	Not Reported	Comment 6:	Not Reported
Comment 7:	Not Reported		
System no:	3010027	System nam:	City Of Orange
Hqname:	Not Reported	Address:	P O BOX 449
City:	ORANGE	State:	Not Reported
Zip:	92666	Zip ext:	Not Reported
Pop serv:	116800	Connection:	30144
Area serve:	ORANGE		

J52
North
1/2 - 1 Mile
Higher

CA WELLS CAPFAS000000949

Well ID:	3010082-007	Well Type:	MUNICIPAL
Source:	Department of Health Services		
Other Name:	WELL 05 011	GAMA PFAS Testing:	Yes
Groundwater Quality Data:	https://gamagroundwater.waterboards.ca.gov/gama/gamamap/public/GamaDataDisplay.asp?dataset=DHS&samp_date=&global_id=&assigned_name=3010082-007&store_num=		
GeoTracker Data:	Not Reported		

J53
North
1/2 - 1 Mile
Higher

CA WELLS CADDW0000016600

Well ID:	3010082-007	Well Type:	MUNICIPAL
Source:	Department of Health Services		

GEOCHECK® - PHYSICAL SETTING SOURCE MAP FINDINGS

Other Name:	WELL 05 011	GAMA PFAS Testing:	Not Reported
Groundwater Quality Data:	https://gamagroundwater.waterboards.ca.gov/gama/gamamap/public/GamaDataDisplay.asp?dataset=DHS&samp_date=&global_id=&assigned_name=3010082-007&store_num=		
GeoTracker Data:	Not Reported		

K54
SSW
1/2 - 1 Mile
Lower

CA WELLS CAEDF0000132165

Well ID:	T0605901781-MW-1	Well Type:	MONITORING
Source:	EDF	Other Name:	MW-1
GAMA PFAS Testing:	Not Reported		
Groundwater Quality Data:	https://gamagroundwater.waterboards.ca.gov/gama/gamamap/public/GamaDataDisplay.asp?dataset=EDF&samp_date=&global_id=T0605901781&assigned_name=MW-1&store_num=		
GeoTracker Data:	https://geotracker.waterboards.ca.gov/profile_report.asp?cmd=MWEDFResults&global_id=T0605901781&assigned_name=MW-1		

K55
SSW
1/2 - 1 Mile
Lower

CA WELLS CAEDF0000045816

Well ID:	T0605901781-MW-3	Well Type:	MONITORING
Source:	EDF	Other Name:	MW-3
GAMA PFAS Testing:	Not Reported		
Groundwater Quality Data:	https://gamagroundwater.waterboards.ca.gov/gama/gamamap/public/GamaDataDisplay.asp?dataset=EDF&samp_date=&global_id=T0605901781&assigned_name=MW-3&store_num=		
GeoTracker Data:	https://geotracker.waterboards.ca.gov/profile_report.asp?cmd=MWEDFResults&global_id=T0605901781&assigned_name=MW-3		

56
North
1/2 - 1 Mile
Higher

CA WELLS 5040

Seq:	5040	Prim sta c:	04S/09W-22M01 S
Frds no:	3010082005	County:	30
District:	08	User id:	TEE
System no:	3010082	Water type:	G
Source nam:	WELL 03	Station ty:	WELL/AMBNT/MUN/INTAKE/SUPPLY
Latitude:	334836.2	Longitude:	1174855.5
Precision:	2	Status:	AU
Comment 1:	Not Reported	Comment 2:	Not Reported
Comment 3:	Not Reported	Comment 4:	Not Reported
Comment 5:	Not Reported	Comment 6:	Not Reported
Comment 7:	Not Reported		
System no:	3010082	System nam:	Serrano Id
Hqname:	Not Reported	Address:	18021 EAST LINCOLN
City:	VILLA PARK	State:	Not Reported
Zip:	92667	Zip ext:	Not Reported
Pop serv:	6500	Connection:	2129
Area serve:	VILLA PARK CITY		
Sample date:	03-MAY-17	Finding:	1.21

GEOCHECK® - PHYSICAL SETTING SOURCE MAP FINDINGS

Chemical: Dir:	NITRATE + NITRITE (AS N) 0.4	Report units:	MG/L
Sample date: Chemical: Dir:	03-MAY-17 NITRATE (AS N) 0.4	Finding: Report units:	1.2 MG/L
Sample date: Chemical: Dir:	08-AUG-16 NITRATE (AS N) 0.4	Finding: Report units:	1.41 MG/L
Sample date: Chemical: Dir:	08-AUG-16 NITRATE + NITRITE (AS N) 0.4	Finding: Report units:	1.42 MG/L
Sample date: Chemical: Dir:	14-JUN-16 NITRATE (AS N) 0.4	Finding: Report units:	1.31 MG/L
Sample date: Chemical: Dir:	14-JUN-16 NITRATE + NITRITE (AS N) 0.4	Finding: Report units:	1.31 MG/L
Sample date: Chemical: Dir:	17-MAR-16 NITRATE (AS N) 0.4	Finding: Report units:	1.48 MG/L
Sample date: Chemical: Dir:	17-MAR-16 TOTAL DISSOLVED SOLIDS 0.	Finding: Report units:	622. MG/L
Sample date: Chemical: Dir:	17-MAR-16 TURBIDITY, LABORATORY 0.1	Finding: Report units:	0.4 NTU
Sample date: Chemical: Dir:	17-MAR-16 NITRATE + NITRITE (AS N) 0.4	Finding: Report units:	1.48 MG/L
Sample date: Chemical: Dir:	17-MAR-16 NITRATE (AS N) 0.4	Finding: Report units:	1.48 MG/L
Sample date: Chemical: Dir:	17-MAR-16 TOTAL DISSOLVED SOLIDS 0.	Finding: Report units:	620. MG/L
Sample date: Chemical: Dir:	17-MAR-16 TURBIDITY, LABORATORY 0.1	Finding: Report units:	0.4 NTU
Sample date: Chemical: Dir:	17-MAR-16 NITRATE + NITRITE (AS N) 0.4	Finding: Report units:	1.49 MG/L
Sample date: Chemical: Dir:	06-MAY-15 PH, LABORATORY 0.	Finding: Report units:	7.8 Not Reported
Sample date: Chemical: Dir:	06-MAY-15 ALKALINITY (TOTAL) AS CaCO3 0.	Finding: Report units:	205. MG/L

GEOCHECK® - PHYSICAL SETTING SOURCE MAP FINDINGS

Sample date:	06-MAY-15	Finding:	250.
Chemical:	BICARBONATE ALKALINITY	Report units:	MG/L
Dir:	0.		
Sample date:	06-MAY-15	Finding:	0.56
Chemical:	TOTAL ORGANIC CARBON (TOC)	Report units:	MG/L
Dir:	0.3		
Sample date:	06-MAY-15	Finding:	335.
Chemical:	HARDNESS (TOTAL) AS CaCO ₃	Report units:	MG/L
Dir:	0.		
Sample date:	06-MAY-15	Finding:	87.2
Chemical:	CALCIUM	Report units:	MG/L
Dir:	0.		
Sample date:	06-MAY-15	Finding:	28.5
Chemical:	MAGNESIUM	Report units:	MG/L
Dir:	0.		
Sample date:	06-MAY-15	Finding:	74.8
Chemical:	SODIUM	Report units:	MG/L
Dir:	0.		
Sample date:	06-MAY-15	Finding:	1.7
Chemical:	POTASSIUM	Report units:	MG/L
Dir:	0.		
Sample date:	06-MAY-15	Finding:	101.
Chemical:	CHLORIDE	Report units:	MG/L
Dir:	0.		
Sample date:	06-MAY-15	Finding:	144.
Chemical:	SULFATE	Report units:	MG/L
Dir:	0.5		
Sample date:	06-MAY-15	Finding:	0.21
Chemical:	FLUORIDE (F) (NATURAL-SOURCE)	Report units:	MG/L
Dir:	0.1		
Sample date:	06-MAY-15	Finding:	180.
Chemical:	BORON	Report units:	UG/L
Dir:	100.		
Sample date:	06-MAY-15	Finding:	624.
Chemical:	TOTAL DISSOLVED SOLIDS	Report units:	MG/L
Dir:	0.		
Sample date:	06-MAY-15	Finding:	6.3
Chemical:	NITRATE (AS NO ₃)	Report units:	MG/L
Dir:	2.		
Sample date:	06-MAY-15	Finding:	0.3
Chemical:	TURBIDITY, LABORATORY	Report units:	NTU
Dir:	0.1		
Sample date:	06-MAY-15	Finding:	0.2
Chemical:	BROMIDE	Report units:	MG/L
Dir:	0.		
Sample date:	06-MAY-15	Finding:	1420.
Chemical:	NITRATE + NITRITE (AS N)	Report units:	MG/L

GEOCHECK® - PHYSICAL SETTING SOURCE MAP FINDINGS

Dir:	0.4		
Sample date:	06-MAY-15	Finding:	952.
Chemical:	SPECIFIC CONDUCTANCE	Report units:	US
Dir:	0.		
Sample date:	21-MAY-14	Finding:	6.1
Chemical:	NITRATE (AS NO3)	Report units:	MG/L
Dir:	2.		
Sample date:	21-MAY-14	Finding:	1370.
Chemical:	NITRATE + NITRITE (AS N)	Report units:	MG/L
Dir:	0.4		
Sample date:	21-MAY-14	Finding:	0.845
Chemical:	GROSS ALPHA COUNTING ERROR	Report units:	PCI/L
Dir:	0.		
Sample date:	21-MAY-14	Finding:	0.503
Chemical:	RADIUM 228 COUNTING ERROR	Report units:	PCI/L
Dir:	0.		
Sample date:	21-MAY-14	Finding:	0.322
Chemical:	RADIUM, TOTAL, MDA95-NTNC ONLY, BY 903.0		
Report units:	PCI/L	Dir:	0.
Sample date:	21-MAY-14	Finding:	1.11
Chemical:	GROSS ALPHA MDA95	Report units:	PCI/L
Dir:	0.		
Sample date:	21-MAY-14	Finding:	0.3
Chemical:	URANIUM MDA95	Report units:	PCI/L
Dir:	0.		
Sample date:	21-MAY-14	Finding:	0.2
Chemical:	RADIUM 228 MDA95	Report units:	PCI/L
Dir:	0.		
Sample date:	21-MAY-14	Finding:	0.111
Chemical:	RA-226 OR TOTAL RA BY 903.0 C.E.	Report units:	PCI/L
Dir:	0.		
Sample date:	21-MAY-14	Finding:	0.635
Chemical:	URANIUM COUNTING ERROR	Report units:	PCI/L
Dir:	0.		
Sample date:	03-SEP-13	Finding:	1010.
Chemical:	SPECIFIC CONDUCTANCE	Report units:	US
Dir:	0.		
Sample date:	05-JUN-13	Finding:	4.7
Chemical:	NITRATE (AS NO3)	Report units:	MG/L
Dir:	2.		
Sample date:	05-JUN-13	Finding:	1050.
Chemical:	NITRATE + NITRITE (AS N)	Report units:	MG/L
Dir:	0.4		
Sample date:	19-JUN-12	Finding:	1060.
Chemical:	SPECIFIC CONDUCTANCE	Report units:	US
Dir:	0.		

GEOCHECK® - PHYSICAL SETTING SOURCE MAP FINDINGS

Sample date:	19-JUN-12	Finding:	850.
Chemical:	NITRATE + NITRITE (AS N)	Report units:	MG/L
Dir:	0.4		
Sample date:	19-JUN-12	Finding:	219.
Chemical:	ALKALINITY (TOTAL) AS CaCO3	Report units:	MG/L
Dir:	0.		
Sample date:	19-JUN-12	Finding:	267.
Chemical:	BICARBONATE ALKALINITY	Report units:	MG/L
Dir:	0.		
Sample date:	19-JUN-12	Finding:	0.65
Chemical:	TOTAL ORGANIC CARBON (TOC)	Report units:	MG/L
Dir:	0.3		
Sample date:	19-JUN-12	Finding:	374.
Chemical:	HARDNESS (TOTAL) AS CaCO3	Report units:	MG/L
Dir:	0.		
Sample date:	19-JUN-12	Finding:	96.1
Chemical:	CALCIUM	Report units:	MG/L
Dir:	0.		
Sample date:	19-JUN-12	Finding:	32.6
Chemical:	MAGNESIUM	Report units:	MG/L
Dir:	0.		
Sample date:	19-JUN-12	Finding:	79.9
Chemical:	SODIUM	Report units:	MG/L
Dir:	0.		
Sample date:	19-JUN-12	Finding:	2.
Chemical:	POTASSIUM	Report units:	MG/L
Dir:	0.		
Sample date:	19-JUN-12	Finding:	112.
Chemical:	CHLORIDE	Report units:	MG/L
Dir:	0.		
Sample date:	19-JUN-12	Finding:	175.
Chemical:	SULFATE	Report units:	MG/L
Dir:	0.5		
Sample date:	19-JUN-12	Finding:	0.18
Chemical:	FLUORIDE (F) (NATURAL-SOURCE)	Report units:	MG/L
Dir:	0.1		
Sample date:	19-JUN-12	Finding:	200.
Chemical:	BORON	Report units:	UG/L
Dir:	100.		
Sample date:	19-JUN-12	Finding:	700.
Chemical:	TOTAL DISSOLVED SOLIDS	Report units:	MG/L
Dir:	0.		
Sample date:	19-JUN-12	Finding:	3.8
Chemical:	NITRATE (AS NO3)	Report units:	MG/L
Dir:	2.		
Sample date:	19-JUN-12	Finding:	0.21
Chemical:	BROMIDE	Report units:	MG/L

GEOCHECK® - PHYSICAL SETTING SOURCE MAP FINDINGS

Dir: 0.

Sample date: 19-JUN-12
 Chemical: PH, LABORATORY
 Dir: 0.

Finding: 8.
 Report units: Not Reported

K57
SSW
1/2 - 1 Mile
Lower

CA WELLS CAEDF0000117440

Well ID: T0605901781-MW-2 Well Type: MONITORING
 Source: EDF Other Name: MW-2
 GAMA PFAS Testing: Not Reported
 Groundwater Quality Data: https://gamagroundwater.waterboards.ca.gov/gama/gamamap/public/GamaDataDisplay.asp?dataset=EDF&samp_date=&global_id=T0605901781&assigned_name=MW-2&store_num=
 GeoTracker Data: https://geotracker.waterboards.ca.gov/profile_report.asp?cmd=MWEDFResults&global_id=T0605901781&assigned_name=MW-2

58
SW
1/2 - 1 Mile
Lower

CA WELLS CADWR8000005540

State Well #: 04S09W28Q001S Station ID: 47347
 Well Name: SC-4/MP8 Well Use: Observation
 Well Type: Part of a nested/multi-completion well
 Well Depth: 1148 Basin Name: Coastal Plain Of Orange County
 Well Completion Rpt #: 344373,74

L59
NNE
1/2 - 1 Mile
Higher

CA WELLS CADPR0000000040

Well ID: 79758 Well Type: UNK
 Source: Department of Pesticide Regulation
 Other Name: 79758 GAMA PFAS Testing: Not Reported
 Groundwater Quality Data: https://gamagroundwater.waterboards.ca.gov/gama/gamamap/public/GamaDataDisplay.asp?dataset=DPR&samp_date=&global_id=&assigned_name=79758&store_num=
 GeoTracker Data: Not Reported

60
NNE
1/2 - 1 Mile
Higher

CA WELLS CADDW0000000377

Well ID: 3010082-006 Well Type: MUNICIPAL
 Source: Department of Health Services
 Other Name: WELL 04 010 GAMA PFAS Testing: Not Reported
 Groundwater Quality Data: https://gamagroundwater.waterboards.ca.gov/gama/gamamap/public/GamaDataDisplay.asp?dataset=DHS&samp_date=&global_id=&assigned_name=3010082-006&store_num=
 GeoTracker Data: Not Reported

GEOCHECK® - PHYSICAL SETTING SOURCE MAP FINDINGS

Map ID
 Direction
 Distance
 Elevation

Database EDR ID Number

L61
NNE
1/2 - 1 Mile
Higher

CA WELLS 5039

Seq:	5039	Prim sta c:	04S/09W-22G01 S
Frds no:	3010082006	County:	30
District:	08	User id:	TEE
System no:	3010082	Water type:	G
Source nam:	WELL 04	Station ty:	WEL/AMBNT/MUN/INTAKE/SUPPLY
Latitude:	334839.9	Longitude:	1174829.9
Precision:	2	Status:	AU
Comment 1:	LOCATED ~140' E OF LEMON ST., & 65' S OF VILLA PARK DR.		
Comment 2:	Not Reported	Comment 3:	Not Reported
Comment 4:	Not Reported	Comment 5:	Not Reported
Comment 6:	Not Reported	Comment 7:	Not Reported

System no:	3010082	System nam:	Serrano Id
Hqname:	Not Reported	Address:	18021 EAST LINCOLN
City:	VILLA PARK	State:	Not Reported
Zip:	92667	Zip ext:	Not Reported
Pop serv:	6500	Connection:	2129
Area serve:	VILLA PARK CITY		

Sample date:	19-JUL-12	Finding:	480.
Chemical:	NITRATE + NITRITE (AS N)	Report units:	MG/L
Dir:	0.4		

Sample date:	19-JUL-12	Finding:	2.1
Chemical:	NITRATE (AS NO3)	Report units:	MG/L
Dir:	2.		

Sample date:	19-JUN-12	Finding:	2.1
Chemical:	NITRATE (AS NO3)	Report units:	MG/L
Dir:	2.		

Sample date:	19-JUN-12	Finding:	0.3
Chemical:	TURBIDITY, LABORATORY	Report units:	NTU
Dir:	0.1		

Sample date:	19-JUN-12	Finding:	0.23
Chemical:	BROMIDE	Report units:	MG/L
Dir:	0.		

Sample date:	19-JUN-12	Finding:	480.
Chemical:	NITRATE + NITRITE (AS N)	Report units:	MG/L
Dir:	0.4		

Sample date:	19-JUN-12	Finding:	190.
Chemical:	BORON	Report units:	UG/L
Dir:	100.		

Sample date:	19-JUN-12	Finding:	170.
Chemical:	IRON	Report units:	UG/L
Dir:	100.		

Sample date:	19-JUN-12	Finding:	1080.
Chemical:	TOTAL DISSOLVED SOLIDS	Report units:	MG/L
Dir:	0.		

GEOCHECK® - PHYSICAL SETTING SOURCE MAP FINDINGS

Sample date:	19-JUN-12	Finding:	0.21
Chemical:	FLUORIDE (F) (NATURAL-SOURCE)	Report units:	MG/L
Dir:	0.1		
Sample date:	19-JUN-12	Finding:	1120.
Chemical:	SPECIFIC CONDUCTANCE	Report units:	US
Dir:	0.		
Sample date:	19-JUN-12	Finding:	7.7
Chemical:	PH, LABORATORY	Report units:	Not Reported
Dir:	0.		
Sample date:	19-JUN-12	Finding:	225.
Chemical:	ALKALINITY (TOTAL) AS CaCO3	Report units:	MG/L
Dir:	0.		
Sample date:	19-JUN-12	Finding:	275.
Chemical:	BICARBONATE ALKALINITY	Report units:	MG/L
Dir:	0.		
Sample date:	19-JUN-12	Finding:	1.08
Chemical:	TOTAL ORGANIC CARBON (TOC)	Report units:	MG/L
Dir:	0.3		
Sample date:	19-JUN-12	Finding:	390.
Chemical:	HARDNESS (TOTAL) AS CaCO3	Report units:	MG/L
Dir:	0.		
Sample date:	19-JUN-12	Finding:	99.4
Chemical:	CALCIUM	Report units:	MG/L
Dir:	0.		
Sample date:	19-JUN-12	Finding:	34.4
Chemical:	MAGNESIUM	Report units:	MG/L
Dir:	0.		
Sample date:	19-JUN-12	Finding:	86.8
Chemical:	SODIUM	Report units:	MG/L
Dir:	0.		
Sample date:	19-JUN-12	Finding:	3.1
Chemical:	POTASSIUM	Report units:	MG/L
Dir:	0.		
Sample date:	19-JUN-12	Finding:	134.
Chemical:	CHLORIDE	Report units:	MG/L
Dir:	0.		
Sample date:	19-JUN-12	Finding:	190.
Chemical:	SULFATE	Report units:	MG/L
Dir:	0.5		
Sample date:	01-MAR-12	Finding:	5020.
Chemical:	NITRATE + NITRITE (AS N)	Report units:	MG/L
Dir:	0.4		
Sample date:	01-MAR-12	Finding:	22.18
Chemical:	NITRATE (AS NO3)	Report units:	MG/L
Dir:	2.		

GEOCHECK® - PHYSICAL SETTING SOURCE MAP FINDINGS

Map ID
Direction
Distance
Elevation

Database EDR ID Number

L62
NNE
1/2 - 1 Mile
Higher

CA WELLS CADPR000001473

Well ID:	79757	Well Type:	UNK
Source:	Department of Pesticide Regulation		
Other Name:	79757	GAMA PFAS Testing:	Not Reported
Groundwater Quality Data:	https://gamagroundwater.waterboards.ca.gov/gama/gamamap/public/GamaDataDisplay.asp?dataset=DPR&samp_date=&global_id=&assigned_name=79757&store_num=		
GeoTracker Data:	Not Reported		

63
WSW
1/2 - 1 Mile
Lower

CA WELLS CADPR000002842

Well ID:	79766	Well Type:	UNK
Source:	Department of Pesticide Regulation		
Other Name:	79766	GAMA PFAS Testing:	Not Reported
Groundwater Quality Data:	https://gamagroundwater.waterboards.ca.gov/gama/gamamap/public/GamaDataDisplay.asp?dataset=DPR&samp_date=&global_id=&assigned_name=79766&store_num=		
GeoTracker Data:	Not Reported		

1G
SSW
1/2 - 1 Mile
Lower

AQUIFLOW 68248

Site ID:	083002014T
Groundwater Flow:	NW
Shallow Water Depth:	21.19
Deep Water Depth:	37.97
Average Water Depth:	Not Reported
Date:	12/31/1998

GEOCHECK® - PHYSICAL SETTING SOURCE MAP FINDINGS RADON

AREA RADON INFORMATION

State Database: CA Radon

Radon Test Results

Zipcode	Num Tests	> 4 pCi/L
92869	37	1

Federal EPA Radon Zone for ORANGE County: 3

- Note: Zone 1 indoor average level > 4 pCi/L.
 : Zone 2 indoor average level >= 2 pCi/L and <= 4 pCi/L.
 : Zone 3 indoor average level < 2 pCi/L.

Federal Area Radon Information for ORANGE COUNTY, CA

Number of sites tested: 30

Area	Average Activity	% <4 pCi/L	% 4-20 pCi/L	% >20 pCi/L
Living Area - 1st Floor	0.763 pCi/L	100%	0%	0%
Living Area - 2nd Floor	Not Reported	Not Reported	Not Reported	Not Reported
Basement	Not Reported	Not Reported	Not Reported	Not Reported

PHYSICAL SETTING SOURCE RECORDS SEARCHED

TOPOGRAPHIC INFORMATION

USGS 7.5' Digital Elevation Model (DEM)

Source: United States Geologic Survey

EDR acquired the USGS 7.5' Digital Elevation Model in 2002 and updated it in 2006. The 7.5 minute DEM corresponds to the USGS 1:24,000- and 1:25,000-scale topographic quadrangle maps. The DEM provides elevation data with consistent elevation units and projection.

Current USGS 7.5 Minute Topographic Map

Source: U.S. Geological Survey

HYDROLOGIC INFORMATION

Flood Zone Data: This data was obtained from the Federal Emergency Management Agency (FEMA). It depicts 100-year and 500-year flood zones as defined by FEMA. It includes the National Flood Hazard Layer (NFHL) which incorporates Flood Insurance Rate Map (FIRM) data and Q3 data from FEMA in areas not covered by NFHL.

Source: FEMA

Telephone: 877-336-2627

Date of Government Version: 2003, 2015

NWI: National Wetlands Inventory. This data, available in select counties across the country, was obtained by EDR in 2002, 2005 and 2010 from the U.S. Fish and Wildlife Service.

State Wetlands Data: Wetland Inventory

Source: Department of Fish and Wildlife

Telephone: 916-445-0411

HYDROGEOLOGIC INFORMATION

AQUIFLOW^R Information System

Source: EDR proprietary database of groundwater flow information

EDR has developed the AQUIFLOW Information System (AIS) to provide data on the general direction of groundwater flow at specific points. EDR has reviewed reports submitted to regulatory authorities at select sites and has extracted the date of the report, hydrogeologically determined groundwater flow direction and depth to water table information.

GEOLOGIC INFORMATION

Geologic Age and Rock Stratigraphic Unit

Source: P.G. Schruben, R.E. Arndt and W.J. Bawiec, Geology of the Conterminous U.S. at 1:2,500,000 Scale - A digital representation of the 1974 P.B. King and H.M. Beikman Map, USGS Digital Data Series DDS - 11 (1994).

STATSGO: State Soil Geographic Database

Source: Department of Agriculture, Natural Resources Conservation Service (NRCS)

The U.S. Department of Agriculture's (USDA) Natural Resources Conservation Service (NRCS) leads the national Conservation Soil Survey (NCSS) and is responsible for collecting, storing, maintaining and distributing soil survey information for privately owned lands in the United States. A soil map in a soil survey is a representation of soil patterns in a landscape. Soil maps for STATSGO are compiled by generalizing more detailed (SSURGO) soil survey maps.

SSURGO: Soil Survey Geographic Database

Source: Department of Agriculture, Natural Resources Conservation Service (NRCS)

Telephone: 800-672-5559

SSURGO is the most detailed level of mapping done by the Natural Resources Conservation Service, mapping scales generally range from 1:12,000 to 1:63,360. Field mapping methods using national standards are used to construct the soil maps in the Soil Survey Geographic (SSURGO) database. SSURGO digitizing duplicates the original soil survey maps. This level of mapping is designed for use by landowners, townships and county natural resource planning and management.

PHYSICAL SETTING SOURCE RECORDS SEARCHED

LOCAL / REGIONAL WATER AGENCY RECORDS

FEDERAL WATER WELLS

PWS: Public Water Systems

Source: EPA/Office of Drinking Water

Telephone: 202-564-3750

Public Water System data from the Federal Reporting Data System. A PWS is any water system which provides water to at least 25 people for at least 60 days annually. PWSs provide water from wells, rivers and other sources.

PWS ENF: Public Water Systems Violation and Enforcement Data

Source: EPA/Office of Drinking Water

Telephone: 202-564-3750

Violation and Enforcement data for Public Water Systems from the Safe Drinking Water Information System (SDWIS) after August 1995. Prior to August 1995, the data came from the Federal Reporting Data System (FRDS).

USGS Water Wells: USGS National Water Inventory System (NWIS)

This database contains descriptive information on sites where the USGS collects or has collected data on surface water and/or groundwater. The groundwater data includes information on wells, springs, and other sources of groundwater.

OTHER STATE DATABASE INFORMATION

Groundwater Ambient Monitoring & Assessment Program

State Water Resources Control Board

Telephone: 916-341-5577

The GAMA Program is California's comprehensive groundwater quality monitoring program. GAMA collects data by testing the untreated, raw water in different types of wells for naturally-occurring and man-made chemicals. The GAMA data includes Domestic, Monitoring and Municipal well types from the following sources, Department of Water Resources, Department of Health Services, EDF, Agricultural Lands, Lawrence Livermore National Laboratory, Department of Pesticide Regulation, United States Geological Survey, Groundwater Ambient Monitoring and Assessment Program and Local Groundwater Projects.

Water Well Database

Source: Department of Water Resources

Telephone: 916-651-9648

California Drinking Water Quality Database

Source: Department of Public Health

Telephone: 916-324-2319

The database includes all drinking water compliance and special studies monitoring for the state of California since 1984. It consists of over 3,200,000 individual analyses along with well and water system information.

California Oil and Gas Well Locations

Source: Dept of Conservation, Geologic Energy Management Division

Telephone: 916-323-1779

Oil and Gas well locations in the state.

California Earthquake Fault Lines

Source: California Division of Mines and Geology

The fault lines displayed on EDR's Topographic map are digitized quaternary fault lines prepared in 1975 by the United State Geological Survey. Additional information (also from 1975) regarding activity at specific fault lines comes from California's Preliminary Fault Activity Map prepared by the California Division of Mines and Geology.

RADON

State Database: CA Radon

Source: Department of Public Health

Telephone: 916-210-8558

Radon Database for California

PHYSICAL SETTING SOURCE RECORDS SEARCHED

Area Radon Information

Source: USGS

Telephone: 703-356-4020

The National Radon Database has been developed by the U.S. Environmental Protection Agency (USEPA) and is a compilation of the EPA/State Residential Radon Survey and the National Residential Radon Survey. The study covers the years 1986 - 1992. Where necessary data has been supplemented by information collected at private sources such as universities and research institutions.

EPA Radon Zones

Source: EPA

Telephone: 703-356-4020

Sections 307 & 309 of IRRA directed EPA to list and identify areas of U.S. with the potential for elevated indoor radon levels.

OTHER

Airport Landing Facilities: Private and public use landing facilities

Source: Federal Aviation Administration, 800-457-6656

Epicenters: World earthquake epicenters, Richter 5 or greater

Source: Department of Commerce, National Oceanic and Atmospheric Administration

California Earthquake Fault Lines: The fault lines displayed on EDR's Topographic map are digitized quaternary fault lines, prepared in 1975 by the United State Geological Survey. Additional information (also from 1975) regarding activity at specific fault lines comes from California's Preliminary Fault Activity Map prepared by the California Division of Mines and Geology.

STREET AND ADDRESS INFORMATION

© 2015 TomTom North America, Inc. All rights reserved. This material is proprietary and the subject of copyright protection and other intellectual property rights owned by or licensed to Tele Atlas North America, Inc. The use of this material is subject to the terms of a license agreement. You will be held liable for any unauthorized copying or disclosure of this material.

APPENDIX C

GEOTECHNICAL BASELINE AND DESIGN REPORT



Converse Consultants

Geotechnical Engineering
Environmental & Groundwater Science
Inspection & Testing Services

GEOTECHNICAL INVESTIGATION REPORT

OCWD PFAS TREATMENT FACILITY
ORANGE PARK ACRES WELL NO. 1 WELLHEAD FACILITIES
678 NORTH GRAVIER STREET
CITY OF ORANGE, CALIFORNIA

CONVERSE PROJECT NO. 20-32-172-01

Prepared For:

AECOM

Mr. Alex Franchi, PhD, PE, BCEE
US West Region Water Process Practice Lead
999 Town and Country Road
Orange, California 92868

Presented By:

CONVERSE CONSULTANTS

717 South Myrtle Avenue
Monrovia, California 91016
626-930-1200

April 2, 2021



Converse Consultants

75 Years of Dedication in Geotechnical Engineering & Consulting, Environmental & Groundwater Science, Materials Testing & Inspection Services

April 2, 2021

Mr. Alex Franchi, PhD, PE, BCEE
US West Region Water Process Practice Lead
AECOM
999 Town and Country Road
Orange, California 92868

Subject: **GEOTECHNICAL INVESTIGATION REPORT**
OCWD PFAS Treatment Facility
Orange Park Acres Well No. 1 Wellhead Facilities
678 North Gravier Street
City of Orange, California
Converse Project No. 20-32-172-01

Dear Mr. Franchi:

Converse Consultants (Converse) has prepared this report to present the results of our geotechnical investigation conducted to assist with the design of the proposed OCWD PFAS Treatment Facility located at 678 North Gravier Street in the City of Orange, California. This report was prepared in accordance with our proposal dated November 24, 2020 and your subcontract with PO No. 131760 effective February 1, 2021.

Based on the results of our field exploration, laboratory testing and engineering analysis, we conclude that the site is suitable for the proposed development from a geotechnical standpoint provided the recommendations presented in this report are incorporated during the design and construction of the project.

We appreciate the opportunity to be of service to AECOM. Should you have any questions, please do not hesitate to contact us at (626) 930-1200.

Sincerely,

CONVERSE CONSULTANTS

A handwritten signature in blue ink that reads "Carlos V. Amante".

Carlos V. Amante, PE, GE
Principal Engineer/Managing Officer

PROFESSIONAL CERTIFICATION

This report has been prepared by the staff of Converse under the professional supervision of the individuals whose seals and signatures appear hereon.

The findings, recommendations, specifications, or professional opinions contained in this report were prepared in accordance with generally accepted professional engineering and engineering geologic principles and practice in this area of Southern California. There is no warranty, either expressed or implied.



Babak Abbasi, PhD, EIT
Senior Staff Engineer



Mark Schluter, PG, CEG, CHG
Senior Engineering Geologist



Carlos V. Amante, PE, GE
Principal Engineer/Managing Officer



EXECUTIVE SUMMARY

The following is a summary of our geotechnical investigation, conclusions and recommendations as presented in this report. Please refer to the pertinent section of this report for complete conclusions and recommendations. In the event of a conflict between this summary and the report, or an omission in the summary, the report shall prevail.

- The proposed PFAS treatment facility will be located at the existing house (660 North Gravier Street), south of Well No. 1 wellhead facilities, operated by IRWD. The site is surrounded to the west, and south by residential neighborhoods, and to the east by Gravier Street. The Santiago Creek Recharge Basin is located across East Bond Avenue immediately to the northeast of the project site. The Well No. 1 is presently occupied with chemical building, surge tank, Well No. 1 pump facility, electrical room, and electrical transformer. The existing house owned by IRWD will be demolished and the PFAS treatment facility will be constructed at the site. The surface elevation of the project site is approximately 290 feet above mean sea level (amsl).
- Based on information provided by Alex Franchi with AECOM, two options are proposed for the location of new PFAS treatment facility and associated improvements. For the first option, the PFSA facility will be located west of project site with a 34-foot-wide driveway at east side of facility. The water treatment system will be supported on an approximately 41 feet x 50 feet concrete pad. For the second option, the proposed PFAS facility will be located south of project site with a 30-foot-wide access driveway at north side of facility. The water treatment system will be supported on an approximately 41 feet x 49 feet concrete pad. For both options, the elevation of top of concrete pad will be approximately 10 feet below existing ground surface. The project also includes construction of a pipeline that runs from the treatment plant to Well No. 1 wellhead facilities. The maximum depth to pipe invert will be approximately 15 feet below existing ground surface.
- To investigate the subsurface conditions at the project site, two (2) exploratory borings (BH-1 and BH-2) were drilled on February 25, 2021 to the planed depth of 26.5 feet below ground surface (bgs). The approximate locations of the borings are shown on Drawing No. 2, *Boring Location Map*. A detailed discussion of the field exploration program and boring logs are presented in Appendix A, *Field Exploration*.
- The subsurface soil conditions consisted of artificial fill underlain by native alluvial deposits. Artificial fill was encountered in the borings to a maximum depth of 6.5 feet bgs. The fill material consists of poorly graded gravels with silt (GP-GM), possibly brought to the site during the previous site grading and development. The native alluvial sediments consisted of poorly graded gravels and silty sands. Gravel and cobbles up to 5.0 inches in largest dimension were encountered during



drilling. Broken pieces of rocks were also encountered, indicating that cobbles larger than 5.0 inches and possible boulders are present in the site subsurface.

- Groundwater was not encountered in any of our borings to a maximum explored depth of 26.5 feet bgs. Based on a regional database (SWRCB, 2020), groundwater levels at site location #L10009578462 in Well MW-4 located approximately 1.4 miles northeast of the project site, was measured to 19.45 feet bgs in May, 2020. The historical highest groundwater level contour at the site is reported to be between 25 and 30 feet bgs (CGS, 1997).
- The site is not located within a current State of California Earthquake Fault Zone. Based on review of available geologic information, no major surface fault crosses through or extends towards the site. The potential for surface rupture resulting from the movement of nearby major faults, or currently unknown faults, is not known with certainty but is considered low.
- The project site is located in an area designated as susceptible to potential liquefaction by the State of California (CGS, 1999). Based on liquefaction analysis, liquefaction of saturated soils at the project site is unlikely to occur. The potential for surface manifestations of liquefaction, such as sand boils and surface fissures are considered to be low.
- Seismic settlement due to densification of soil particles during ground shaking is in the order of 1.6 inches. The seismic differential settlement may be taken as equal to one-half of the total settlement over 30 horizontal feet.
- The risk to the site from lateral spreading, landslides, and tsunamis is considered to be low. Seiching in the Santiago Creek Recharge Basin, located across East Bond Avenue immediately northeast of the project site, could result in site flooding. The project site is located downstream approximately 3.6 miles from the Villa Park Dam and 7.5 miles from the Santiago Dam. Failure of either one of these dams during an earthquake may result in flooding of the project site.
- Mapped and site-specific seismic design parameters based on the current (2019) Building Code are presented in Table Nos. 2 and 3, respectively.
- The sulfate contents of the sampled soils correspond to American Concrete Institute (ACI) exposure category S0 for these sulfate concentrations. No concrete type restrictions are specified for exposure category S0. A minimum compressive strength of 2,500 psi is recommended. The chloride contents of the sampled soils correspond to American Concrete Institute (ACI) exposure category C1 (concrete is exposed to moisture, but not to external sources of chlorides). For exposure category C1, ACI provides concrete compressive strength of at least 2,500 psi and a maximum chloride content of 0.3 percent.



- Based on the soil corrosivity test results, the soils are considered moderately corrosive to concrete and ferrous metals. According to ACI 318-14, a minimum compressive strength of 2,500 psi and maximum chloride content of 0.3 percent are recommended for concrete based on sulfate and chloride exposure categories. Additional corrosion testing should be performed at the completion of grading or as recommended by a qualified corrosion consultant. Converse does not practice in the area of corrosion consulting. A qualified corrosion consultant should provide appropriate corrosion mitigation measures.
- Based on our subsurface exploration, we anticipate that the site soils will be excavatable with conventional heavy-duty earthmoving equipment. Gravels and cobbles were encountered in our borings and will be encountered during grading and construction. Boulders may also be encountered during construction. These oversized rocks may result in difficult excavation. As discussed in Section 8.4, Engineering Fill, oversized materials larger than 3 inches are not suitable for use in compacted fill and should be removed if the excavated soil is to be re-used as compacted fill. Oversized rocks should be disposed of offsite. Excavated onsite earth materials cleared of deleterious matter and oversize rock can be moisture conditioned and re-used as compacted fill.
- To provide uniform support for the proposed foundations, the existing soils should be over-excavated and replaced with engineered fill to a minimum depth of 3 feet below the bottom of foundations, or 5 feet below the lowest adjacent grade, whichever is deeper. The over-excavation and re-compaction should extend laterally at least 5 feet beyond the footprints of the foundations. The over-excavation and re-compaction should be deepened as needed to remove any existing fill, and any very soft or saturated soil. The bottom of excavation should be scarified to a depth of 8 inches and compacted to at least 90 percent of the laboratory maximum dry density as determined by ASTM D1557 test method.
- Fill soils should be placed on scarified and recompacted excavation bottoms, moisture conditioned, and compacted to at least 90 percent of the laboratory maximum dry density. A minimum of 12 inches of fill beneath pavement intended to support vehicle loads should be compacted to at least 95 percent of the laboratory maximum dry density.
- Shallow foundation and mat foundation design parameters and recommendations are presented in Sections 9.1 and 9.2, respectively.
- The settlement due to static loading of the foundations, designed as recommended above, from structural load-induced loads is anticipated to be less than one-half (0.5) inch. Differential settlement due to structural loadings is anticipated to be less than one quarter (0.25) inches. The site has a potential for seismic settlement of



1.6 inches. The seismic differential settlement may be estimated to be up to one-half of the total settlement in horizontal span of 30 feet. The static and seismic settlements should be considered cumulatively in the design of the onsite structures. The total static and seismic differential settlement is anticipated to be in order of one (1) inch in horizontal span of 30 feet.

- Recommendations on lateral earth pressures and resistance to lateral loads are presented in Section 9.3.

Based on our investigation, it is our professional opinion that the site is suitable for the construction of the proposed improvements provided the recommendations presented in this geotechnical investigation report are implemented in the planning, design, and construction of the project.



TABLE OF CONTENTS

1.0	INTRODUCTION-----	1
2.0	SITE AND PROJECT DESCRIPTION-----	1
3.0	SCOPE OF WORK-----	2
3.1	EXISTING DOCUMENT REVIEW-----	2
3.2	PROJECT SET-UP-----	2
3.3	SUBSURFACE EXPLORATION-----	2
3.4	LABORATORY TESTING-----	2
3.5	ENGINEERING ANALYSES AND GEOTECHNICAL REPORT PREPARATION-----	3
4.0	GEOLOGIC SETTING-----	3
4.1	REGIONAL GEOLOGY-----	3
4.2	SITE GEOLOGY-----	4
5.0	SUBSURFACE CONDITIONS-----	4
5.1	SUBSURFACE PROFILE-----	4
5.2	GROUNDWATER-----	4
5.3	SUBSURFACE VARIATIONS-----	5
5.4	EXCAVATABILITY-----	5
5.5	FLOODING-----	5
6.0	FAULTING AND SEISMICITY-----	5
6.1	FAULTING-----	5
6.2	HISTORIC SEISMICITY-----	7
6.3	SEISMIC HAZARD ANALYSIS-----	7
6.4	SECONDARY EFFECTS OF SEISMIC ACTIVITY-----	8
7.0	LABORATORY TEST RESULTS-----	11
7.1	PHYSICAL TESTING-----	11
7.2	CHEMICAL TESTING - CORROSIVITY EVALUATION-----	12
8.0	EARTHWORK RECOMMENDATIONS-----	12
8.1	GENERAL-----	13
8.2	REMEDIAL GRADING-----	13
8.3	BACKFILL RECOMMENDATIONS BEHIND WALL-----	14
8.4	ENGINEERED FILL-----	15
8.5	COMPACTED FILL PLACEMENT-----	15
8.6	SHRINKAGE AND SUBSIDENCE-----	16
8.7	SITE DRAINAGE-----	16
9.0	DESIGN RECOMMENDATIONS-----	16
9.1	SHALLOW FOUNDATION DESIGN PARAMETERS-----	16
9.2	MAT FOUNDATION DESIGN PARAMETERS-----	17
9.3	LATERAL EARTH PRESSURES AND RESISTANCE TO LATERAL LOADS-----	18
9.4	SETTLEMENT-----	19



9.5	SLABS-ON-GRADE	19
9.6	SOIL CORROSIVITY	21
9.7	CONCRETE FLATWORK	21
9.8	BEARING PRESSURE FOR ANCHOR AND THRUST BLOCKS	22
10.0	CONSTRUCTION RECOMMENDATIONS	22
10.1	GENERAL	22
10.2	TEMPORARY SLOPED EXCAVATIONS	23
10.3	SHORING DESIGN	23
11.0	GEOTECHNICAL SERVICES DURING CONSTRUCTION	24
12.0	CLOSURE	25
13.0	REFERENCES	26

Drawings

	Following Page Number
Drawing No. 1, Site Location Map	1
Drawing No. 2, Boring Location Map	2
Drawing No. 3, Regional Geologic Map	3
Drawing No. 4, Southern California Regional Fault Map	6
Drawing No. 5, Epicenter Map of Southern California Earthquakes (1800-1999)	7
Drawing No. 6, Seismic Hazard Zones Map	9
Drawing No. 7, Recommended Lateral Earth Pressure for Braced Excavation	24

Tables

	Page Number
Table No. 1, Summary of Regional Faults	6
Table No. 2, 2019 CBC Mapped Seismic Parameters	7
Table No. 3, 2019 CBC Site-Specific Seismic Parameters	8
Table No. 4, Recommended Foundation Design Parameters	17
Table No. 5, Recommended Lateral Earth Pressures	18
Table No. 6, Slope Ratios for Temporary Excavations	23

Appendices

Appendix A	Field Exploration
Appendix B	Laboratory Testing Program
Appendix C	Seismic Hazard Analysis Results
Appendix D	Liquefaction and Seismic Settlement Analysis Results



1.0 INTRODUCTION

This report presents the results of our geotechnical investigation performed for the OCWD PFAS Treatment Facility Project, located at 678 North Gravier Street, in the City of Orange, Orange County, California. The approximate location of facility is shown on Drawing No. 1, *Site Location Map*.

The purposes of this investigation were to determine the nature and engineering properties of the subsurface soils, to conduct a geohazard evaluation of the site, and provide recommendations for seismic design, site earthwork, and design and construction of foundations for the proposed development.

This report is prepared for the project described herein and is intended for use solely by AECOM, Irvine Ranch Water District (IRWD), and their authorized agents for design purposes. It should not be used as a bidding document but may be made available to the potential contractors for information on factual data only. For bidding purposes, the contractors should be responsible for making their own interpretation of the data contained in this report.

2.0 SITE AND PROJECT DESCRIPTION

The project site is located on the southwest side of the intersection of East Bond Avenue and North Gravier Street in the City of Orange, Orange County, California. The site is surrounded to the west and south by residential neighborhoods, and to the east by Gravier Street. The Santiago Creek Recharge Basin is located across East Bond Avenue immediately to the northeast of the project site. The proposed PFAS treatment facility will be located at the existing house (660 North Gravier Street), south of Well No. 1 wellhead facilities, operated by IRWD. The Well No. 1 is presently occupied with chemical building, surge tank, Well No. 1 pump facility, electrical room, and electrical transformer. The existing house owned by IRWD will be demolished and a new treatment facility will be constructed at the site. The surface elevation of the project site is approximately 290 feet above mean sea level (amsl).

Based on information provided by Alex Franchi with AECOM, two options are proposed for the location of new PFAS treatment facility and associated improvements. For the first option, the PFSA facility will be located west of project site with a 34-foot-wide driveway at east side of facility. The water treatment system will be supported on an approximately 41 feet x 50 feet concrete pad. For the second option, the proposed PFAS facility will be located south of project site with a 30-foot-wide access driveway at north side of facility. The water treatment system will be supported on an approximately 41 feet x 49 feet concrete pad. For both options, the elevation of top of concrete pad will be approximately 10 feet below existing ground surface. The project also includes construction of a pipeline



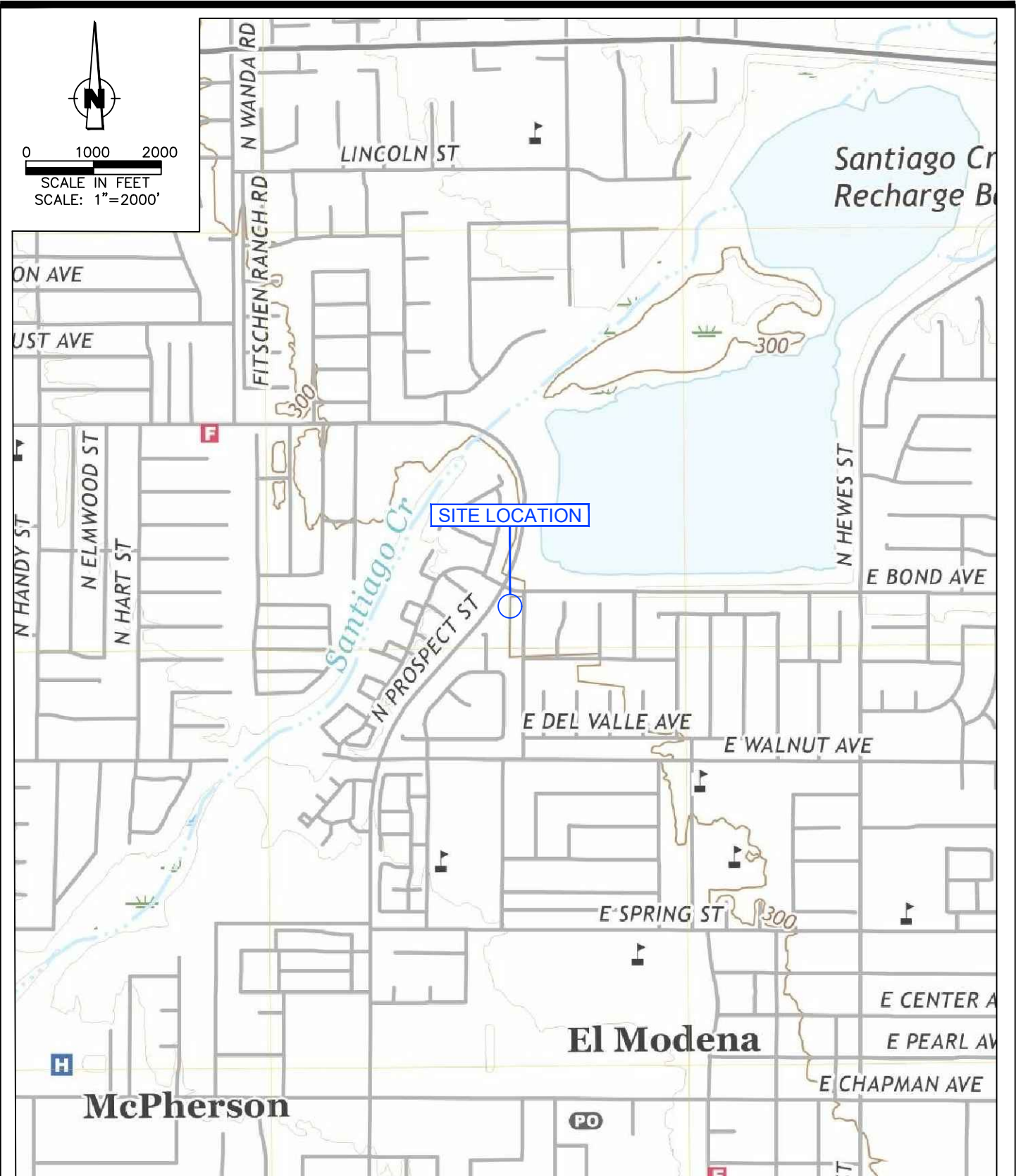

SITE LOCATION MAP

OCWD PFAS Treatment Facility
 Orange Park Acres Well No. 1 Wellhead Facilities
 678 N. Gravier Street
 City of Orange, California

Project No.
 20-32-172-01



Drawing No.

1

that runs from the treatment plant to Well No. 1 wellhead facilities. The maximum depth to pipe invert will be approximately 15 feet below existing ground surface.

3.0 SCOPE OF WORK

The scope of Converse's investigation included the tasks described in the following sections.

3.1 Existing Document Review

Converse reviewed available existing report and as-built utility plans for the project. Besides the existing report by Converse, we reviewed geohazard and groundwater maps to evaluate any impact on the design and construction of the proposed project.

3.2 Project Set-up

The project set-up consisted of the following tasks.

- Conducted a site reconnaissance and marked the exploration locations, such that equipment access to all the locations was available.
- Coordinated with the representative AECOM to clear the exploration locations for underground utilities.
- Notified Underground Service Alert (USA) at least 48 hours prior to field work to clear the exploration locations of any conflict with existing underground utilities.
- Engaged a California licensed drilling subcontractors.

3.3 Subsurface Exploration

To investigate the subsurface conditions at the project site, two (2) exploratory borings (BH-1 and BH-2) were drilled on February 25, 2021 to depth of 26.5 feet below ground surface (bgs). The approximate locations of the borings are shown on Drawing No. 2, *Boring Location Map*. A detailed discussion of the field exploration program and boring logs are presented in Appendix A, *Field Exploration*.

3.4 Laboratory Testing

Representative samples of the site soils were tested in the laboratory to aid in the classification and to evaluate relevant engineering properties. The tests performed included the following.

- *In Situ* Moisture Content and Dry Density (ASTM Standard D2216 and D7263)
- Soil Corrosivity (California Test 643, 422, and 417)
- Grain Size Distribution (ASTM Standard C136)





BORING LOCATION MAP

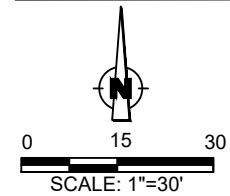

LEGEND

BH-1  APPROXIMATE BORING LOCATION



Converse Consultants

OCWD PFAS Treatment Facility
 Orange Park Acres Well No. 1 Wellhead Facilities
 678 N. Gravier Street
 City of Orange, California

PROJECT NO.
 20-32-172-01

DRAWING NO.
 2

- Maximum Dry Density and Optimum Moisture Content (ASTM Standard D1557)
- Direct Shear Strength (ASTM Standard D3080)
- Swell/Collapse (ASTM Standard D4546)
- Atterberg Limits (ASTM Standard D4318)

For *in situ* moisture and density data, see the Logs of Borings in Appendix A, *Field Exploration*. For a description of the other laboratory test methods and test results, see Appendix B, *Laboratory Testing Program*.

3.5 Engineering Analyses and Geotechnical Report Preparation

Data obtained from the field exploration and laboratory testing program was compiled and evaluated. Geotechnical analyses of the compiled data were performed, and this report was prepared to present our findings, conclusions, and recommendations for the proposed improvements.

4.0 GEOLOGIC SETTING

The regional and local geology are discussed in the following subsections.

4.1 Regional Geology

The project site is located within the Peninsular Ranges Geomorphic Province of California. The Peninsular Ranges province is characterized by northwest trending valleys and mountain ranges, which have formed in response to regional tectonic forces along the boundary between the Pacific and North American tectonic plates. The geologic structure is dominated by the northwest trending right-lateral faults, most notable, the San Andreas fault, San Jacinto fault, Elsinore fault, Whittier fault, and the Newport-Inglewood fault. The province extends southward from the Transverse Ranges province at the north end of the Los Angeles basin to the southern tip of the Baja California Peninsula.

The project site is situated on a broad alluvial basin along the eastern portion of the Orange County coastal plain. The coastal plain has been gradually filled with Quaternary-age sediments. The Santa Ana River, Santiago Creek and local drainage tributaries have deposited stream sediments across the coastal plain during Holocene time (0-11,000 years) to form a relatively flat and broad river flood plain. Most of the river and stream channel flows are now controlled by an extensive network of flood control channels and storm drains which drain to the Santiago Creek and Santa Ana River flood control channels and then to the Pacific Ocean. Please see Drawing No. 3, *Regional Geologic Map*.



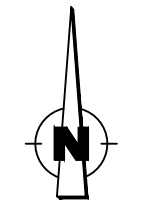

NOT TO SCALE

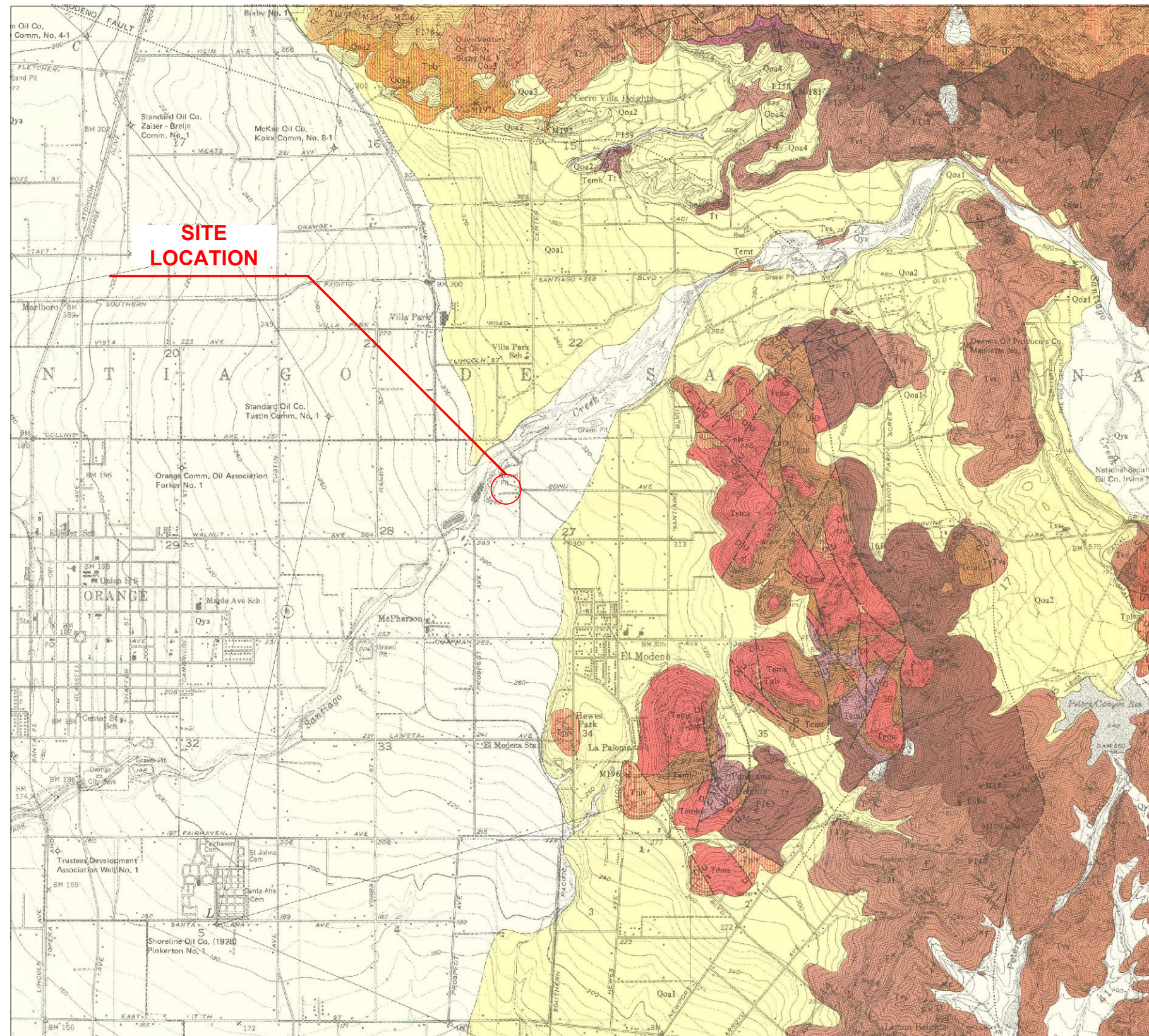

EXPLANATION	
<p>Qya Younger alluvium Gravel, sand, and silt</p>	
<p>Qoa1 Qoa2 Qoa3 Qoa4 Older alluvium Sand, gravel, and rubble, locally reddish brown in color. Terrace surfaces along Santiago Creek have been tentatively correlated, and each terrace is numbered in order of age: Qoa1, the youngest</p>	
<p>Qh La Habra Formation White massive poorly sorted pebbly sandstone, yellowish-brown, reddish-brown, and greenish-gray sandy mudstone, earthy sandstone and conglomerate; nonmarine. Exposed north of Santa Ana River, present in subsurface only south of river</p>	<p>Qda Deformed alluvial deposits Gray to reddish-brown rubble and gravel; faulted & folded</p>
<p>Ttu Upper member Brownish-yellow to greenish-gray conglomerate sandstone, and micaceous siltstone</p>	<p>Ts Brownish-yellow conglomerate and interbedded sandstone</p>
<p>Ttl Lower member Greenish-gray massive to moderately well bedded micaceous siltstone and sandstone with minor amounts of conglomerate</p>	
<p>Tps Sycamore Canyon Member Brownish-yellow to gray fine- to coarse-grained sandstone with interbedded gray micaceous siltstone</p>	
<p>Tpy Yorba Member Chocolate-brown to pinkish-gray massive to well-laminated siltstone, light-gray laminated siltstone and diatomaceous siltstone, yellowish-brown limy siltstone concretions, thin-bedded sandstone</p>	<p>Tso Oso Member White medium- to coarse-grained massive sandstone and</p>
<p>Tps Soquel Member Brownish-yellow to gray medium-grained to pebbly sandstone, interbedded gray micaceous siltstone, local conglomerate</p>	<p>Tpl La Vida and Yorba Members, undifferentiated Light-gray, chocolate-brown, and black siltstone, diatomaceous siltstone, thin-bedded sandstone</p>
<p>Tpl La Vida Member Chocolate-brown to black siltstone, locally contains phosphatic nodules and thin-bedded sandstone tu2, white vitric tuff in southeast corner of area ss, lenticular sandstone, conglomerate, and breccia tuff, buff sandy andesitic tuff or volcanic sandstone locally lying between Puente and Topanga Formations</p>	<p>Tm Monterey Shale White to gray punky siltstone and shale and thin-bedded</p>
<p>Tena Andesite flows and flow breccia Red, buff, and gray vesicular andesite flows and flow breccias; interbedded tuffaceous and limy breccias</p>	
<p>Temt Palagonite tuff and tuff-breccia Light-buff palagonite tuff and tuff-breccia of andesitic composition, in part water-laid</p>	
<p>Tem Basalt flows Gray to black vesicular porphyritic olivine basalt flows, locally overlain by thin-bedded limy organic siltstone</p>	<p>Tem El Modeno Volcanics, undifferentiated Interbedded andesite and basalt flows, flow breccias, palagonite tuff and tuff-breccia</p>

REFERENCE: THOMAS W. DIBBLE, Jr. (DF-91)
SANTA ANA QUADRANGLE 1999

REGIONAL GEOLOGIC MAP



OCWD PFAS Treatment Facility
Orange Park Acres Well No. 1 Wellhead Facilities
678 N. Gravier Street
City of Orange, California

Project No. Drawing No.

20-32-172-01 3

4.2 Site Geology

The project site is underlain by Pleistocene to Holocene unconsolidated alluvial fan deposits, which are primarily composed of mixtures of gravels, sands and silt (Morton and Miller, 2006). These deposits were derived from the weathering and erosion of the Santa Ana Mountains to the east, and then transported to the area via the Santiago Creek, which has a present day course approximately 0.2 miles northwest of the project site.

The near-surface alluvium is likely underlain by late to middle Pleistocene age old alluvial fan deposits.

5.0 SUBSURFACE CONDITIONS

A general description of the subsurface conditions and various materials encountered during our field exploration are presented in this section.

5.1 Subsurface Profile

5.1.1 Artificial Fill

Artificial fill was encountered in the borings to a maximum depth of 6.5 feet bgs. The fill material consists of poorly graded gravel with silt (GP-GM).

5.1.2 Alluvium

The alluvium materials encountered in the exploratory borings consisted predominantly of poorly graded gravel and silty sand. Gravel and cobbles up to 5.0 inches in largest dimension were encountered during drilling. Broken pieces of rocks were also encountered, indicating that cobbles larger than 5.0 inches and possible boulders are present in the site subsurface.

For a detailed description of the subsurface materials encountered in the exploratory borings, see Drawing Nos. A-3 and A-4, *Logs of Borings*, in Appendix A, *Field Exploration*.

5.2 Groundwater

Groundwater was not encountered in any of our borings to a maximum explored depth of 26.5 feet bgs. Based on a regional database (SWRCB, 2020), groundwater levels at site location #L10009578462 in well MW-4 located approximately 1.4 miles northeast of the project site, was measured to 19.45 feet bgs in May, 2020. The historical highest groundwater level contour at the site is reported to be between 25 and 30 feet bgs (CGS, 1997).



Groundwater is not expected to be encountered during the construction of this project. The groundwater level may vary depending upon the seasonal precipitation, infiltration from surface channels such as the nearby Santiago Creek, irrigation, and possible groundwater recharge and pumping activity in the site vicinity.

5.3 Subsurface Variations

Based on the results of subsurface exploration and our experience, some variations in the continuity and nature of subsurface conditions within the project site should be anticipated. Because of the uncertainties involved in the nature and depositional characteristics of the earth materials at the site, care should be exercised in interpolating or extrapolating subsurface conditions between or beyond the boring locations.

5.4 Excavatability

Based on our field exploration, the earth materials at the site should be excavatable with conventional heavy-duty earth moving and trenching equipment. Gravels and cobbles were encountered in our borings, and will be encountered during construction. Boulders may also be encountered during construction. These oversized rocks may result in difficult excavation. As discussed in Section 8.4, Fill Placement, oversized materials larger than 3 inches are not suitable for use in compacted fill and should be removed if the excavated soil is to be re-used as compacted fill. Oversized rocks should be disposed of offsite.

5.5 Flooding

Review of the Flood Insurance Rate Map (FEMA, 2009), Map Number 06059C0162J, dated December 3, 2009, from the FEMA Map Service Center Viewer, indicates that the site is in an area designated as Zone X, "Areas of 0.2% annual chance flood; areas of 1% annual chance flood with average depths less than 1 foot or with drainage areas less than 1 square mile." Due to the absence of groundwater at shallow depths, distance of the subject site from large bodies of water and regional flood control structures, the potential for flooding at the subject site is considered low.

6.0 FAULTING AND SEISMICITY

Discussion of faulting and seismicity is presented in the following sections.

6.1 Faulting

In California, the Alquist-Priolo Earthquake Fault Zoning Act regulates development in the vicinity of active faults. For purposes of the Act, California defines an active fault as one which has had surface displacement within Holocene time, or about the last 11,000 years.



The site is not located within a currently designated State of California Earthquake Fault Zone (CGS, 2007). Based on a review of existing geologic information no known active surface fault zone crosses or projects toward the site.

The proposed site is situated in a seismically active region. As is the case for most areas of Southern California, ground-shaking resulting from earthquakes associated with nearby and more distant faults may occur at the project site. During the life of the project, seismic activity associated with active faults can be expected to generate moderate to strong ground shaking at the site. The approximate locations of these local active faults with respect to the project site are shown on Drawing No. 4, *Southern California Regional Fault Map*.

The following table contains a list of active and potentially active faults within 50 kilometers of the subject site based on site coordinates of 33.7980 degrees North (latitude) and 117.8148 degrees West (longitude).

Table No. 1, Summary of Regional Faults

Fault Name and Section	Closest Distance (km)	Slip Sense	Length (km)	Slip Rate (mm/year)	Maximum Magnitude
Elsinore	11.63	strike slip	241	n/a	7.8
Puente Hills (Coyote Hills)	12.03	thrust	17	0.7	6.9
San Joaquin Hills	12.23	thrust	27	0.5	7.1
Chino, alt 2	19.5	strike slip	29	1	6.8
Chino, alt 1	19.55	strike slip	24	1	6.7
Elsinore;GI+T+J+CM	21.02	strike slip	195	n/a	7.7
Newport Inglewood Connected alt 2	21.4	strike slip	208	1.3	7.5
Newport Inglewood Connected alt 1	21.52	strike slip	208	1.3	7.5
Puente Hills (Santa Fe Springs)	23.94	thrust	11	0.7	6.7
Newport-Inglewood (Offshore)	24.77	strike slip	66	1.5	7.0
San Jose	27.42	strike slip	20	0.5	6.7
Puente Hills (LA)	34.52	thrust	22	0.7	7.0
Sierra Madre Connected	36.33	reverse	76	2	7.3
Cucamonga	37.14	thrust	28	5	6.7
Palos Verdes Connected	38.82	strike slip	285	3	7.7
Elysian Park (Upper)	39.97	reverse	20	1.3	6.7
Elsinore;T+J+CM	41.96	strike slip	169	n/a	7.6
Raymond	43.63	strike slip	22	1.5	6.5
Clamshell-Sawpit	45.44	reverse	16	0.5	6.5
Verdugo	48.48	reverse	29	0.5	6.7

(Source: https://earthquake.usgs.gov/cfusion/hazfaults_2008_search/)



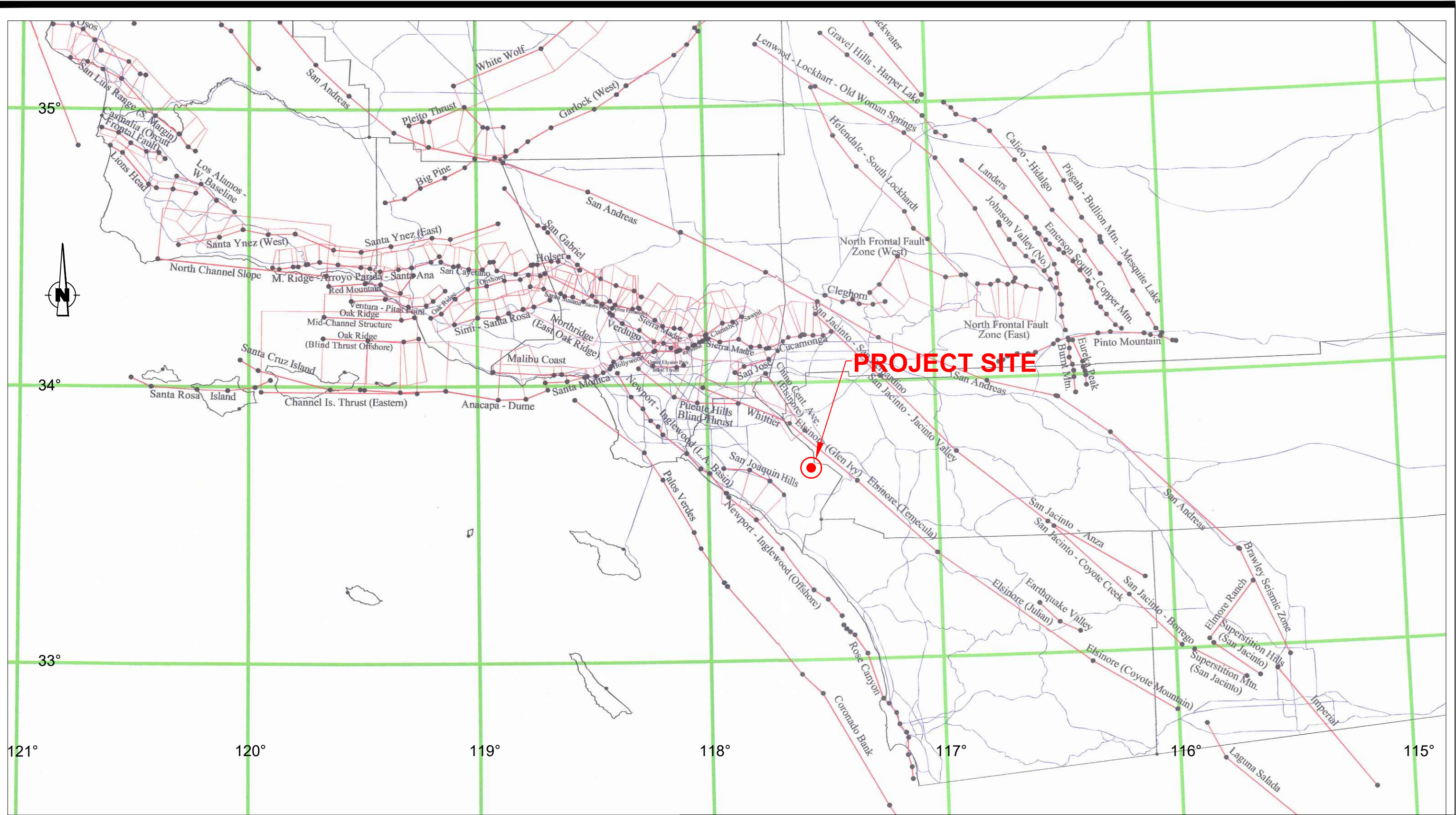

REFERENCE: PORTION OF CGS 2002 CALIFORNIA FAULT MODEL
 MODIFIED FOR USE WITH FRISKSP AND EQFAULT
 BY THOMAS F. BLAKE, AUGUST 2004

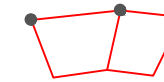
-  FAULT SOURCES
-  BLIND THRUST FAULT,
POLYGONS INDICATE RUPTURE
PLANES AND DIP DIRECTION

SOUTHERN CALIFORNIA REGIONAL FAULT MAP



Converse Consultants

OCWD PFAS Treatment Facility
Orange Park Acres Well No. 1 Wellhead Facilities
 678 N. Gravier Street
 City of Orange, California

Project No.
20-31-172-01

Drawing NO.
4

6.2 Historic Seismicity

We have reviewed California Geologic Survey Map Sheet 49; Epicenters and Areas Damaged by $M \geq 5$ California Earthquakes, 1800-1999, (CGS, Topozada et al., 2000). The mapped epicenters of earthquake with magnitude 5.0 or greater in Southern California during the past 200 years are shown on Drawing No. 5, *Epicenter Map of Southern California Earthquakes (1800-1999)*.

6.3 Seismic Hazard Analysis

6.3.1 Mapped Seismic Parameters

Seismic parameters based on the current edition of California Building Code (CBC, 2019) were determined using the Seismic Design Maps application (ATC, Hazards By Location Tool). The coordinates for the project site are approximately 33.7980 degrees North (latitude) and 117.81481 degrees West (longitude).

Table No. 2, 2019 CBC Mapped Seismic Parameters

Seismic Parameter	Value
Site Class	D
Mapped Spectral Accelerations for short periods, S_S	1.401 g
Mapped Spectral Accelerations for 1-sec period, S_1	0.499 g
Site Coefficient, F_a	1.0
Site Coefficient, F_v	*
⁽¹⁾ MCE_R (5%, damped) Spectral response acceleration for short periods adjusted for site class, S_{MS}	1.401 g
⁽¹⁾ MCE_R (5% damped) spectral response acceleration at 1-second period adjusted for site class, S_{M1}	*
Design spectral response acceleration (5% damped) at short periods, S_{DS}	0.934 g
Design Spectral response acceleration (5% damped) at 1-second period, S_{D1}	*
Site-Modified Peak Ground Acceleration, MCE_G PGA	0.641 g

Notes:

1. MCE_R stands for Risk-Targeted Maximum Considered Earthquake.
 2. MCE_G PGA stands for Maximum Considered Earthquake Geometric Mean Peak Ground Acceleration.
- * No value provided.

6.3.2 Site-Specific Seismic Parameters

Site-specific acceleration parameters were evaluated in accordance with the seismic provisions in Section 21 of ASCE 7-16 guidelines (ASCE, 2016), which were adopted in the 2019 California Building Code. These parameters were determined for the site coordinates and weighted average shear wave velocity from the boring data using the online calculator developed by the Utilization of Ground Motion Simulation (UGMS)



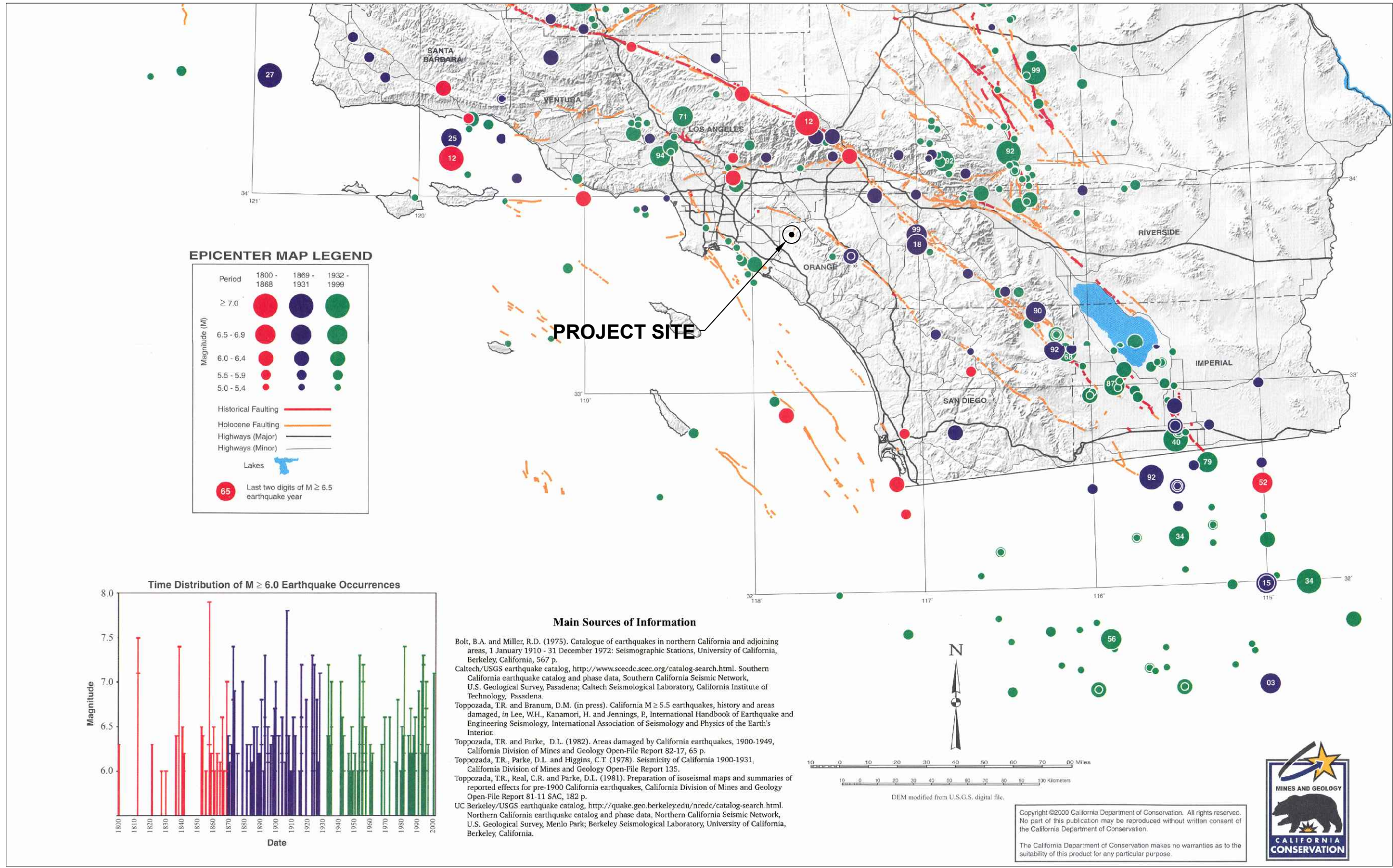

REFERENCE: PORTION OF EPICENTERS AND AREAS DAMAGED BY M≥5 CALIFORNIA EARTHQUAKES, 1800-1999 CALIFORNIA DEPARTMENT OF CONSERVATION, MAP SHEET 49 DATED 2000.

EPICENTER MAP OF SOUTHERN CALIFORNIA EARTHQUAKES (1800-1999)



OCWD PFAS Treatment Facility
 Orange Park Acres Well No. 1 Wellhead Facilities
 678 N. Gravier Street
 City of Orange, California

Project No.
 20-32-172-01

Drawing No.
 5

committee of the Southern California Earthquake Center (SCEC). The recommended site-specific risk-targeted Maximum Considered Earthquake (MCE_R) and design response spectra are presented in Appendix C, *Seismic Hazard Analysis Results*. The following table summarizes the recommended 2019 CBC site-specific seismic design parameters calculated using the UGMS online tool.

Table No. 3, 2019 CBC Site-Specific Seismic Parameters

Seismic Parameter	Value
⁽¹⁾ MCE_R (5%, damped) Spectral response acceleration for short periods adjusted for site class, S_{MS}	1.832 g
⁽¹⁾ MCE_R (5% damped) spectral response acceleration at 1-second period adjusted for site class, S_{M1}	1.155 g
Design spectral response acceleration (5% damped) at short periods, S_{DS}	1.222 g
Design Spectral response acceleration (5% damped) at 1-second period, S_{D1}	0.770 g
Site-Modified Peak Ground Acceleration, MCE_G PGA	0.675 g

Site Class D was determined based on the estimated average shear wave velocity of the site in the upper 30 meters (100 feet), V_{s30} of 276.0 m/sec (906 ft/sec), which was calculated using the SPTPROP software (InfraGEO, 2020) based on the correlations with SPT blow counts by Brandenberg, Bellana and Shantz (2010). Extrapolation of estimated shear wave velocities from 50-ft depth to 100-ft depth was performed using the method proposed by Boore (2004). The Modified California Sampler blow counts were converted to equivalent SPT blow counts by multiplying the value by 0.65 to account for end-area effects.

A seismic deaggregation analysis conducted using the USGS Unified Hazard online tool shows the magnitude 7.72 event located approximately 7.26 miles (11.69 km) from the project site contributes the most to the seismic hazard at the project site.

6.4 Secondary Effects of Seismic Activity

In general, secondary effects of seismic activity include surface fault rupture, soil liquefaction, landslides, lateral spreading, and differential settlement due to seismic shaking, tsunamis, seiches, and earthquake-induced flooding. The site-specific potential for each of these seismic hazards is discussed in the following sections.

6.4.1 Surface Fault Rupture

The site is not located within a State of California Earthquake Fault Zone (CGS, 1999). Based on review of available geologic information, no major surface fault crosses through or extends towards the site. The potential for surface rupture resulting from the movement



of nearby major faults, or currently unknown faults, is not known with certainty but is considered low.

6.4.2 Liquefaction

Liquefaction is defined as the phenomenon in which a cohesionless soil mass within the upper 50 feet of the ground surface, suffers a substantial reduction in its shear strength, due to the development of excess pore pressures. During earthquakes, excess pore pressures in saturated soil deposits may develop as a result of induced cyclic shear stresses, resulting in liquefaction.

Soil liquefaction generally occurs in submerged granular soils and non-plastic silts during or after strong ground shaking. There are several general requirements for liquefaction to occur. They are as follows:

- Soils must be submerged
- Soils must be primarily granular
- Soils must be loose to medium-dense
- Ground motion must be intense
- Duration of shaking must be sufficient for the soils to lose shear resistance

The site location is located in an area designated as susceptible to liquefaction by the State of California (CGS, 1999) as shown in Drawing No. 6, *Seismic Hazard Zones Map*. Groundwater was not encountered to the maximum explored depth of 26.5 feet bgs; neither it was encountered to depth of 50 feet bgs in the 2012 geotechnical investigation by Converse; however, the historical high groundwater level at the site was reported to be between 25 and 30 feet bgs (CGS, 1997).

The site was analyzed for liquefaction and consequent seismically induced settlement using the program SPTLIQ (InfraGEO Software, 2020) and data from BH-3 from the 2012 geotechnical investigation report by Converse. We used the method of Boulanger and Idriss (2014) for liquefaction triggering. The following parameters were used in the analysis:

- Historical high groundwater level of 30 feet bgs.
- Earthquake moment magnitude of M_w of 7.72.
- Peak ground acceleration (PGA) of 0.675g, where g is the acceleration due to gravity.

Based on a site-specific liquefaction analysis presented in Appendix D, *Liquefaction and Seismic Settlement Analysis Results*, liquefaction of saturated soil at the project site is unlikely to occur. The potential for surface manifestations of liquefaction, such as sand boils and surface fissures are considered to be low.





0 1000 2000

SCALE IN FEET
SCALE: 1"=1000'

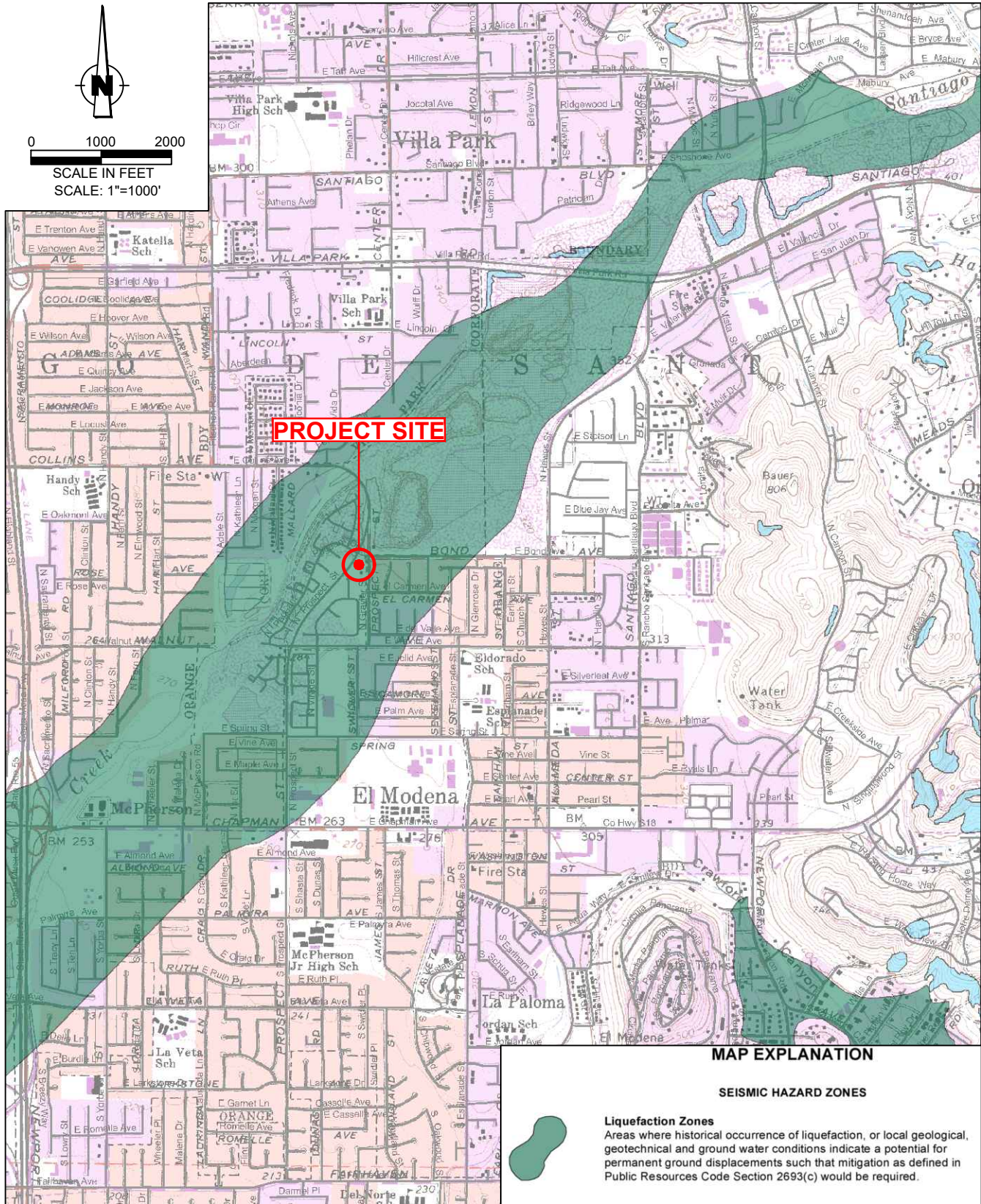

REFERENCE: ORANGE QUADRANGLE 1999
SEISMIC HAZARD ZONES STATE OF CALIFORNIA

SEISMIC HAZARD ZONES MAP



OCWD PFAS Treatment Facility
Orange Park Acres Well No. 1 Wellhead Facilities
678 N. Gravier Street
City of Orange, California

Project No.
20-31-214-01

Drawing No.
6

6.4.3 Seismic Settlement

Seismically induced ground settlement can occur with or without liquefaction which results from densification of loose soils due to strong seismic ground shaking. Seismic settlement includes both settlement of liquefied soil layers and settlement of non-liquefied, unsaturated, loose sandy sediments. We used the methods of Boulanger and Idriss (2014) using the SPT data for liquefaction triggering, Tokimatsu and Seed (1987) to estimate post-liquefaction seismic settlement, and Pradel (1998) to estimate seismic densification of dry sandy soils.

Seismically induced settlement due to densification of soil particles during ground shaking is in the order of 1.6 inches. The seismic differential settlement may be taken as equal to one-half of the total settlement over 30 horizontal feet. The results of our analysis are presented in Appendix D, *Liquefaction and Seismic Settlement Analysis Results*.

6.4.4 Lateral Spreading

Seismically induced lateral spreading involves primarily lateral movement of earth materials over underlying materials which are liquefied due to ground shaking. It differs from the slope failure in that complete ground failure involving large movement does not occur due to the relatively smaller gradient of the initial ground surface. Lateral spreading is demonstrated by near-vertical cracks with predominantly horizontal movement of the soil mass involved. Due to the relatively flat site topography, the site is not considered susceptible to lateral spreading.

6.4.5 Landslides

Seismically induced landslides and other slope failures are common occurrences during or soon after earthquakes. The site location is not located in an area designated as susceptible to landslides by the State of California (CGS, 2001). Due to the relatively flat nature of the project site, the potential for landslides is considered to be low.

6.4.6 Tsunamis

Tsunamis are large waves generated in open bodies of water by fault displacement or major ground movement. Due to the inland location of the site, tsunamis are not considered to be a risk.

6.4.7 Seiches

Seiches are large waves generated in enclosed bodies of water in response to ground shaking. Seiching in the Santiago Creek Recharge Basin, located immediately northeast of the project site, could result in site flooding.



6.4.8 Earthquake-Induced Flooding

Failure of dams or other water-retaining structures in earthquake event may result in flooding. The project site is located downstream approximately 3.6 miles from the Villa Park Dam and 7.5 miles from the Santiago Dam. Failure of either one of these dams during an earthquake may result in flooding of the project site.

7.0 LABORATORY TEST RESULTS

The physical and chemical test results are presented below.

7.1 Physical Testing

Results of the various laboratory tests are presented in Appendix B, *Laboratory Testing Program*, except for the results of *in situ* moisture and dry density tests which are presented on the Logs of Borings in Appendix A, *Field Exploration*. The results are also discussed below.

7.1.1 In-situ Moisture and Dry Density

Artificial fill

In-situ dry density and moisture content was measured for the artificial fill at a depth of 5.0 feet bgs in boring BH-2 where dry density was 117 pounds per cubic foot (pcf) and moisture content was 2 percent.

Alluvium

Results of *in-situ* moisture and dry density tests performed in accordance with ASTM Standard D2216 and D7263 are presented on the Logs of Borings in Appendix A, *Field Exploration*. Dry densities of upper 5 feet alluvium soils was 115.0 pcf with moisture contents of 3 percent at boring BH-1. Results are presented in the log of borings in Appendix A, *Field Exploration*.

7.1.2 Grain Size Analysis

One representative sample was tested to determine the relative grain size distribution in accordance with the ASTM Standard D6913. The test result is graphically presented in Drawing No. B-1, *Grain Size Distribution Result*. Based on the result, soil is classified as Poorly Graded Gravel with silt (GP-GM).

7.1.3 Atterberg Limits

One sample was tested for liquid limit and plastic limit in accordance with ASTM D4318. The plastic limit of 24 and liquid limit of 28 indicate liquid index of 4 for the sample acquired



at 20 feet bgs from boring BH-2. The soil passing sieve number 40 for this sample is classified as ML. Results are presented in Drawing No. B-2, *Atterberg Limits Test Result*.

7.1.4 Maximum Dry Density and Optimum Moisture Content

Typical moisture-density relationship test of one representative sample was tested in accordance with ASTM D1557. The test result is presented in Drawing No. B-3, *Moisture-Density Relationship Results*, in Appendix B, *Laboratory Testing Program*. The laboratory maximum dry densities was 131 pcf and the optimum moisture content was 6.7 percent.

7.1.5 Direct Shear

Two direct shear tests were performed in accordance with ASTM Standard D3080 on relatively undisturbed ring samples. The test results are presented in Drawing No. B-4, *Direct Shear Test Results* in Appendix B, *Laboratory Testing Program*.

7.1.6 Swell/Collapse

One swell/collapse test was performed on relatively undisturbed samples of the site soils, in accordance with ASTM Standard D4546. The test result is shown on Drawing No. B-5, *Swell/Collapse Test Result*, in Appendix B, *Laboratory Testing Program*.

For additional information on the subsurface conditions, see the Logs of Borings in Appendix A, *Field Exploration*.

7.2 Chemical Testing - Corrosivity Evaluation

One representative soil samples were tested to determine minimum electrical resistivity, pH, and chemical content, including soluble sulfate and chloride concentrations. The purpose of this test was to determine the corrosion potential of site soils when placed in contact with common construction materials. This test was performed by EGLab, Inc. (Arcadia, CA) in accordance with California Test Methods 643, 422, and 417. The test results are summarized below and are presented in Table No. B-1 in Appendix B, *Laboratory Testing Program*.

- The pH measurement of the sample was between 8.19.
- The sulfate content of the sample was 0.003 percent by weight.
- The chloride concentration of the sample was 210 ppm.
- The minimum electrical resistivity when saturated was 7,200 ohm-cm.

8.0 EARTHWORK RECOMMENDATIONS

Recommendations for site preparation and remedial grading and estimates of shrinkage and subsidence are provided in the following sections.



8.1 General

This section contains our general recommendations regarding earthwork and grading recommendations for the site. These recommendations are based on the results of our field exploration, laboratory testing, our experience with similar projects, and data evaluation as presented in the preceding sections. These recommendations may need to be modified based on observation of the actual field conditions during grading.

Prior to the start of any earthwork, the site should be cleared of all vegetation, grass, roots, debris, and trees (if any). If needed, existing building, foundations (if any), asphalt concrete (paving area) should be removed from the site. All materials resulting from clearing and grubbing should be removed from the site.

All underground existing utilities and appurtenances should be located at the project site. Such utilities should either be protected in-place or removed and replaced during construction as required by the project specifications. All excavations should be conducted in such a manner as not to cause loss of bearing and/or lateral support of existing structures or utilities.

The final bottom surfaces of all excavations should be observed and approved by the project geotechnical consultant prior to placing any fill. Based on these observations, removal of localized areas deeper than those documented may be required during grading. Therefore, some variations in the depth and lateral extent of excavation recommended in this report should be anticipated.

8.2 Remedial Grading

To provide uniform support for the proposed foundations, the existing soils should be over-excavated and replaced with engineered fill to a minimum depth of 3 feet below the bottom of foundations, or 5 feet below the lowest adjacent grade, whichever is deeper. The over-excavation and re-compaction should extend laterally at least 5 feet beyond the footprints of the foundations. The over-excavation and re-compaction should be deepened as needed to remove any existing fill, and any very soft or saturated soil. All undocumented fill should be removed and replaced with compacted fill. The bottom of excavation should be scarified to a depth of 8 inches and compacted to at least 90 percent of the laboratory maximum dry density as determined by ASTM D1557 test method.

Native soils below the pavement should be over-excavated and recompacted to a minimum depth of twelve (12) inches below the pavement subgrade. The bottoms of the excavations should be scarified to an additional six (6) inches below the over-excavation and recompacted to at least 90 percent of the laboratory maximum dry density. The upper 12 inches beneath pavement subgrade should be compacted to at least 95 percent of the laboratory maximum dry density. The over-excavation and re-compaction should extend to at least two (2) feet beyond the edge of the pavement.



Variations in the depths and lateral extent of over-excavations will be based on observations made by the geotechnical consultant during grading and should be anticipated. The final bottom surfaces of all excavations should be observed and approved by the project geotechnical consultant prior to placing any fill or structures. If isolated pockets of very soft, loose, or pumping subgrade are encountered, the over-excavation should be locally deepened, as needed, to expose undisturbed, firm, and unyielding soils. Over-excavation should not undermine adjacent off-site improvements or structures that are to remain and be protected in place.

If loose, soft, or yielding soil conditions are encountered at the excavation bottom, the following options can be considered:

1. Over-excavate until a firm bottom is reached.
2. Scarify or over-excavate an additional 18 inches deep, and then place at least 18-inch thick layer of compacted base material (CAB or equivalent) to bridge the soft bottom. Base material should be compacted to a minimum 95% relative compaction.
3. Over-excavate an additional 18-inches deep, and then place a layer of geotextile reinforcement (i.e., Mirafi HP570, or equivalent), place an 18-inch-thick layer of compacted base material (CAB or equivalent) to bridge the soft bottom. Base materials should be compacted to a minimum 95% relative compaction. An additional layer of geotextile reinforcement may be needed on top of the compacted base materials depending on the actual site conditions.

The actual depth of removal should be based on recommendations and observations made during grading by the project geotechnical engineer or his designated representative. Therefore, some variations in the depth and lateral extent of over-excavation recommended in this report should be anticipated.

8.3 Backfill Recommendations Behind Wall

Compaction of backfill adjacent to structural walls can produce excessive lateral pressures. Improper types and locations of compaction equipment and/or compaction techniques may damage the walls. The use of heavy compaction equipment should not be permitted within a horizontal distance of 5 feet from the wall. Backfill behind any structural walls within the recommended 5-foot zone should be compacted using lightweight construction equipment such as handheld compactors to avoid overstressing the walls. The compaction of wall backfill should be conducted in accordance with the procedure described in Section 9.5, *Compaction Fill Placement*.



8.4 Engineered Fill

No fill soils or aggregate base material should be placed until excavations and/or natural ground preparation have been observed and approved by the geotechnical consultant. The native granular soils encountered within the project site are generally considered suitable for re-use as compacted fill. Excavated soils should be processed, including removal of roots and debris, removal of oversized particles, mixed, and moisture conditioned, before placing as compacted fill. On-site soils used as fill should meet the following criteria.

- No particles larger than 3 inches in largest dimension.
- Rocks larger than 1 inch should not be placed within the upper 12 inches of subgrade soils.
- Free of all organic matter, debris, or other deleterious material.
- Expansion index of 20 or less.
- Contain less than 30 percent fines (passing #200 sieve).

Imported materials, if required, should meet the above criteria prior to being imported and used as compacted fill. Any imported fills should be tested and approved by geotechnical consultant prior to delivery to the site.

8.5 Compacted Fill Placement

All surfaces to receive structural fills should be scarified to a depth of 8 inches. The soil should be moisture conditioned to within ± 3 percent of optimum moisture content for coarse soils and 2 to 3 percent above optimum moisture content for fine soils. Fill soils should be evenly spread in horizontal lifts not exceeding 8 inches in uncompacted thickness. The scarified soils should be recompacted to at least 90 percent of the laboratory maximum dry density.

All fill placed at the site should be compacted to at least 90 percent of the laboratory maximum dry densities as determined by ASTM Standard D1557 test method unless a higher compaction is specified herein. At least the upper 12 inches of subgrade soils underneath pavements intended to support vehicle loads should be scarified, moisture conditioned, and compacted to at least 95 percent of the laboratory maximum dry density.

To reduce differential settlement, variations in the soil type, degree of compaction and thickness of the engineered fill placed underneath the foundations should be minimized.

Fill materials should not be placed, spread, or compacted during unfavorable weather conditions. When site grading is interrupted by heavy rain, filling operations should not resume until the geotechnical consultant approves the moisture and density conditions of the previously placed fill.



8.6 Shrinkage and Subsidence

The volume of excavated and recompacted soils will decrease as a result of grading. The shrinkage would depend on, among other factors, the depth of cut and/or fill, and the grading method and equipment utilized. For preliminary estimation, shrinkage factors for various units of earth material at the site may be taken as presented below.

- The shrinkage factor (defined as a percentage of soil volume reduction when moisture conditioned and compacted to the average of 92 percent relative compaction) for the upper 5 feet of soils (assumed similar in-situ dry density performed for below 5 feet soils) is estimated to range from 2 to 14 percent. An average value of 8 percent may be used for preliminary earthwork planning.
- Subsidence (defined as the settlement of native materials from the equipment load applied during grading) would depend on the construction methods including type of equipment utilized. Ground subsidence may be negligible as the site is previously graded for the existing structures and buildings.

Although these values are only approximate, they represent our best estimates of the factors to be used to calculate lost volume that may occur during grading. If more accurate shrinkage and subsidence factors are needed, it is recommended that field-testing using the actual equipment and grading techniques be conducted.

8.7 Site Drainage

Adequate positive drainage should be provided away from the structure to prevent ponding and to reduce percolation of water into structural backfill. A desirable slope for surface drainage is 2 percent in landscaped areas and one percent in paved areas. Planters and landscaped areas adjacent to the structure perimeter should be designed to minimize water infiltration into the subgrade soils. Gutters and downspouts should be installed on the roofs of the structures, and runoff should be directed to the storm drain through non-erosive devices.

9.0 DESIGN RECOMMENDATIONS

Recommendations for the design and construction of the proposed facility are presented in the following sections. The recommendations provided are based on the assumption that, in preparing the site, the above earthwork recommendations will be implemented.

9.1 Shallow Foundation Design Parameters

The proposed structures and retaining walls may be supported on continuous spread footing and/or isolated spread footings. Design of the shallow foundations, including



grade beams, should be based on the recommended parameters presented in the table below.

Table No. 4, Recommended Foundation Design Parameters

Parameter	Value
Minimum continuous spread footing width	18 inches
Minimum isolated footing width	24 inches
Minimum continuous or isolated footing depth of embedment below lowest adjacent grade	18 inches
Allowable net bearing capacity	2,500 psf

The allowable net bearing capacity is defined as the maximum allowable net bearing pressure on the ground. It is obtained by dividing the net ultimate bearing capacity by a safety factor. The ultimate bearing capacity is the bearing stress at which ground fails by shear or experiences a limiting amount of settlement at the foundation. The net ultimate bearing capacity is obtained by subtracting the total overburden pressure on a horizontal plane at the foundation level from the ultimate bearing capacity.

For the underground structures, in addition to the above total net bearing capacity, overburden pressure of the soil can be added to support footings. Overburden pressure to be added to support footings can be calculated by using a total unit weight of 60 pcf times the embedded depth. The maximum allowable bearing capacity should be limited to 4,000 psf.

The net allowable bearing values indicated above are for the dead load and frequently applied live loads and are obtained by applying a factor of safety of 3.0 to the net ultimate bearing capacity. If normal code requirements are applied for design, the above allowable bearing capacity may be increased by 33 percent for short duration loading, which will include loading induced by wind or seismic forces.

9.2 Mat Foundation Design Parameters

If mat foundations are utilized, the following recommendations should be followed.

For structural design of the mat, we recommend using a subgrade modulus that models the soil response under structure loads. The modulus of subgrade reaction (k) for design of flexible mat foundations may be estimated from the available soil compressibility data and published charts or from the following formula.

$$k = k_1 [(B+1)/2B]^2$$

Where:



k= vertical modulus of subgrade reaction for mat foundation, kips per cubic feet
 $k_1 = 300$ kcf, normalized modulus of subgrade reaction for 1 square foot footing
 B= foundation width, feet

If needed for structural analysis, following parameters may be used:

E= 4.0 ksi, Young's Modulus
 $\nu = 0.33$, Poisson's Ratio

Mat foundations with a minimum width of 5 feet and embedment depth of 2 feet below ground surface may be designed for allowable net bearing capacity of 2,500 psf for mat foundations founded on compacted native soil. The allowable net bearing capacity may be increased by 500 psf for each foot of depth to the maximum of 4,000 psf. The mat should be reinforced with top and bottom steel, as appropriate, to provide structural continuity and to permit spanning of local irregularities. The mat foundations dimensions and reinforcement should be based on structural design.

9.3 Lateral Earth Pressures and Resistance to Lateral Loads

In the following subsections, the lateral earth pressures and resistance to lateral loads are estimated by using on-site native soils strength parameters obtained from laboratory testing.

9.3.1 Lateral Earth Pressures

The active earth pressure behind any buried wall or foundations depends primarily on the allowable wall movement, type of backfill materials, backfill slopes, wall or foundation inclination, surcharges, and any hydrostatic pressures. The recommended lateral earth pressures for the site are presented in the following table.

Table No. 5, Recommended Lateral Earth Pressures

Loading Conditions	Static Lateral Earth Pressure	Seismic Lateral Earth Pressure
Active earth conditions (wall is free to deflect at least 0.001 radian)	40H psf (equiv. fluid pressure)	20H psf (equiv. fluid pressure)
At-rest (wall is rigid or restrained)	60H psf (equiv. fluid pressure)	NA

Note: psf = pounds per square foot; H = wall height in feet

These pressures assume a level ground surface behind the walls or foundations for a distance greater than the wall height, no surcharge and no hydrostatic pressure. If water pressure is allowed to build up behind the walls, the earth pressures should be reduced by 50 percent and added to a full hydrostatic pressure to compute the design pressures against the walls.



A backdrain or an equivalent system of backfill drainage should be incorporated into retaining wall design. Backfill immediately behind retaining structures should be a free-draining granular material. Water should not be allowed to pond near the tops of walls. To accomplish this, the final backfill surface should be such that all water is diverted away from retaining walls.

9.3.2 Resistance to Lateral Loads

Resistance to lateral loads can be assumed to be provided by friction acting at the base of foundations and by passive earth pressure. Coefficients of friction of 0.34 between mass concrete and soil, 0.30 between formed concrete and soil, and 0.25 between steel and soil may be used. A passive earth pressure of 240 psf per foot of depth may be used for the sides of footings poured against recompacted native soils. A safety factor of 1.5 was applied in calculating passive earth pressure. The maximum value of the passive earth pressure should be limited to 2,500 psf. Due to the low overburden stress of the soil at shallow depth, the upper one foot of passive resistance should be neglected unless the soil is confined by pavement or slab.

Vertical and lateral bearing values indicated above are for the total dead loads and frequently applied live loads. If normal code requirements are applied for design, the above vertical bearing and lateral resistance values may be increased by 33 percent for short duration loading, which will include the effect of wind or seismic forces.

9.4 Settlement

The settlement due to static loading of the foundations, designed as recommended above, from structural load-induced loads is anticipated to be less than one-half (0.5) inch. Differential settlement due to structural loadings is anticipated to be less than one quarter (0.25) inches.

As discussed in Appendix D, the site has a potential for seismic settlement of 1.6 inches. The seismic differential settlement may be estimated to be up to one-half of the total settlement in horizontal span of 30 feet.

The static and seismic settlements should be considered cumulatively in the design of the onsite structures. The total static and seismic differential settlement is anticipated to be in order of one (1) inch.

9.5 Slabs-on-Grade

Slabs-on-grade should be supported on properly compacted fill. Compacted fill used to support slabs-on-grade should be placed and compacted in accordance with Section 8.5, *Compacted Fill Placement*.



Slabs-on-grade should have a minimum thickness of 6 inches for support of nominal ground-floor live loads. Minimum reinforcement for slabs-on-grade should be No. 4 reinforcing bars, spaced at 18-inches on-center each way. Structural design elements of slabs-on-grade, including but not limited to thickness, reinforcement, joint spacing of more heavily loaded slabs will be dependent upon the anticipated loading conditions and the modulus of subgrade reaction of the supporting materials and should be designed by a structural engineer.

Slabs should be designed and constructed as promulgated by the American Concrete Institute (ACI) and the Portland Cement Association (PCA). Care should be taken during concrete placement to avoid slab curling. Prior to the pour of slabs, all utility trenches should be properly backfilled and compacted.

If moisture-sensitive flooring or environments are planned, slabs-on-grade should be protected by 15-mil-thick polyethylene vapor barriers. The subgrade surface should be free of all exposed rocks or other sharp objects prior to placement of the barrier. The barrier should be overlain by 2 inches of sand, to minimize punctures and to aid in the concrete curing. At the discretion of the structure engineer, the sand layer may be eliminated. Converse does not practice in the field of moisture vapor transmission evaluation/mitigation since this does not fall under the geotechnical disciplines. Therefore, we recommend that a qualified person, such as the flooring contractor, structural engineer, and/or architect be consulted to evaluate the general and specific moisture vapor transmission paths and any impact on the proposed construction.

Subgrade for slabs-on-grade should be firm and uniform. All loose or disturbed soils including under-slabs utility trench backfill should be recompacted.

In hot weather, the contractor should take appropriate curing precautions after placement of concrete to minimize cracking or curling of the slabs. The potential for slabs cracking may be lessened by the addition of fiber mesh to the concrete and/or control of the water/cement ratio.

Concrete should be cured by protecting it against loss of moisture and rapid temperature change for at least 7 days after placement. Moist curing, waterproof paper, white polyethylene sheeting, white liquid membrane compound, or a combination thereof may be used after finishing operations have been completed. The edge of concrete slabs exposed after removal of forms should be immediately protected to provide continuous curing.



9.6 Soil Corrosivity

One (1) representative site soil samples was evaluated for corrosivity with respect to common construction materials such as concrete and steel. The test results are presented in Table No. B-1 in Appendix B, *Laboratory Testing Program*.

The sulfate contents of the sampled soils correspond to American Concrete Institute (ACI) exposure category S0 for these sulfate concentrations (ACI 318-14, Table 19.3.1.1). No concrete type restrictions are specified for exposure category S0 (ACI 318-14, Table 19.3.2.1). A minimum compressive strength of 2,500 psi is recommended.

We anticipate that concrete structures such as footings, slab, and concrete pad will be exposed to moisture from precipitation and irrigation. Based on the site locations and the results of chloride testing of the sites soils, we do not anticipate that concrete structures will be exposed to external sources of chlorides, such as deicing chemicals, salt, brackish water, or seawater. ACI specifies exposure category C1 where concrete is exposed to moisture, but not to external sources of chlorides (ACI 318-14, Table 19.3.1.1). ACI provides concrete design recommendations in ACI 318-14, Table 19.3.2.1, including a compressive strength of at least 2,500 psi and a maximum chloride content of 0.3 percent.

The measured values of the minimum electrical resistivity of the samples when saturated was 7,200 Ohm-cm for the site. This indicates that the soils tested at the site are moderately corrosive to ferrous metals in contact with the soil (Romanoff, 1957).

This is a conservative assessment based on limited sampling. Additional corrosion testing should be performed at the completion of grading or as recommended by a qualified corrosion consultant.

Converse does not practice in the area of corrosion consulting. A qualified corrosion consultant should provide appropriate corrosion mitigation measures for any ferrous metals in contact with the site soils.

9.7 Concrete Flatwork

Except as modified herein, Portland cement concrete walks, driveways, access ramps, curb and gutters should be constructed in accordance with Section 303-5, *Concrete Curbs, Walks, Gutters, Cross-Gutters, Alley Intersections, Access Ramps, and Driveways*, of the Standard Specifications for Public Works Construction (Public Works Standards, 2018).

The subgrade soils under the above structures should consist of compacted fill placed as described in this report. Prior to placement of concrete, the upper 12 inches of subgrade soils should be moisture conditioned to between within 3 percent of optimum moisture content for coarse-grained soils and 2 and 3 percent above optimum for fine-grained soils.



Concrete flatwork subjected to pedestrian loading should be at least 5.0 inches thick, or as required by the civil or structural engineer. Transverse joints should be spaced 15 feet or less and should be cut to a depth of one-fourth the slab thickness.

Positive drainage should be provided away from all driveways and sidewalks to prevent seepage of surface and/or subsurface water into the concrete base and/or subgrade.

9.8 Bearing Pressure for Anchor and Thrust Blocks

An allowable net bearing pressure of 2,500 psf may be used for anchor and thrust block design against alluvial soils. Such thrust blocks should be at least 18 inches wide.

If normal code requirements are applied for design, the above recommended bearing capacity and passive resistances may be increased by 33 percent for short duration loading such as seismic loading.

10.0 CONSTRUCTION RECOMMENDATIONS

Temporary sloped excavation and shoring design recommendations are presented in the following sections.

10.1 General

Prior to the start of construction, all existing underground utilities should be located. Such utilities should either be protected in-place or removed and replaced during construction as required by the project specifications.

Vertical braced excavations are feasible at the project site. Sloped excavations may not be feasible in locations adjacent to existing utilities, structures, or other improvements. Recommendations pertaining to temporary excavations are presented in this section.

Depending on the sequence of construction, excavations may be required near existing structures, which may require vertical side wall excavation. Where the side of the excavation is a vertical cut, it should be adequately supported by temporary shoring to protect workers and any adjacent structures.

All applicable requirements of the California Construction and General Industry Safety Orders, the Occupational Safety and Health Act, and the Construction Safety Act should be met. The soils exposed in cuts should be observed during excavation by the geotechnical consultant and the competent person designated by the contractor. If potentially unstable soil conditions are encountered, modifications of slope ratios for temporary cuts may be required.



10.2 Temporary Sloped Excavations

Based on the materials encountered in the exploratory borings, sloped temporary excavations may be constructed according to the slope ratios presented in Table No. 6, *Slope Ratios for Temporary Excavation*. Any loose utility trench backfill or other fill encountered in excavations will be less stable than the native soils. Temporary cuts encountering loose fill or loose dry sand may have to be constructed at a flatter gradient than presented in table below.

Table No. 6, Slope Ratios for Temporary Excavations

Maximum Depth of Cut (feet)	Maximum Slope Ratio* (horizontal: vertical)
0 – 4	Vertical
4 – 8	1.5:1
8+	2:1

*Slope ratio assumed to be uniform from top to toe of slope.

For steeper temporary construction slopes or deeper excavations, or unstable soil encountered during the excavation, shoring or trench shields should be provided by the contractor to protect the workers in the excavation.

Surfaces exposed in slope excavations should be kept moist but not saturated to retard raveling and sloughing during construction. Adequate provisions should be made to protect the slopes from erosion during periods of rainfall. Surcharge loads, including construction materials, should not be placed within 5 feet of the unsupported slope edge. Stockpiled soils with a height higher than 6 feet will require greater distance from trench edges.

10.3 Shoring Design

The following recommendations are provided for use by the engineer during the design of the project to determine shoring requirements. The Contractor will be responsible for the design and certification of shoring considering site-specific excavation requirements.

Temporary shoring will be required where open cut excavations will not be feasible and where there are space limitations for sloped excavations or because of nearby existing structures or facilities. Temporary shoring may consist of conventional soldier piles and lagging, or interlocking sheet pile systems. The shoring may be cantilevered or may be laterally supported by walers and cross bracing. Drilled excavations for soldier piles will require the use of drilling fluids to prevent caving and to maintain an opened hole for pile installation.

In areas where sloped excavations are not feasible, but protection of existing structures is not a concern, a trench box may be used for worker safety in lieu of shoring.



Braced shoring should be designed to support a uniform rectangular lateral earth pressure of 27 psf, based on Drawing No. 7, *Recommended Lateral Earth Pressure for Braced Excavation*.

In addition to the lateral earth pressure, surcharge pressures due to miscellaneous loads, such as soil stockpiles, vehicular traffic or construction equipment located adjacent to the shoring, should be included in the design of the shoring. A uniform lateral pressure of 100 psf should be included in the upper 10 feet of the shoring to account for normal vehicular and construction traffic within 10 feet of the trench excavation. All shoring should be designed and installed in accordance with state and federal safety regulations.

For the design of soldier piles spaced at least two diameters on-center, the passive resistance of the soils adjacent to the piles may be assumed to be 360 psf/ft of embedment depth. Soldier pile members placed in drilled holes should be properly backfilled with a sand/cement slurry or lean concrete in order to develop the required passive resistance. For sheet piles, a passive resistance of 240 psf/ft of embedment, up to a maximum of 2,500 psf, may be used.

The lagging between the soldier piles may consist of pressure-treated wood members or solid steel sheets. In our opinion, steel sheeting is expected to be more expedient than wood lagging to install. Although soldier piles and any bracing used should be designed for the full-anticipated earth pressures and surcharge pressures, the pressures on the lagging are less because of the effect of arching between the soldier piles. Accordingly, the lagging between the piles may be designed for a nominal pressure of up to a maximum of 300 psf.

All applicable requirements of the California Construction and General Industry Safety Orders, the Occupational Safety and Health Act and current amendments, and the Construction Safety Act should be met. The soils exposed in cuts should be observed during excavation by a competent person employed by the contractor. If potentially unstable soil conditions are encountered, modifications of slope ratios for temporary cuts may be required.

11.0 GEOTECHNICAL SERVICES DURING CONSTRUCTION

The project geotechnical consultant should review plans and specifications as the project design progresses. Such review is necessary to identify design elements, assumptions, or new conditions which require revisions or additions to our geotechnical recommendations.

The project geotechnical consultant should be present to observe conditions during construction. Geotechnical observation and testing should be performed as needed to



TEMPORARY BRACED EXCAVATION LATERAL EARTH PRESSURE

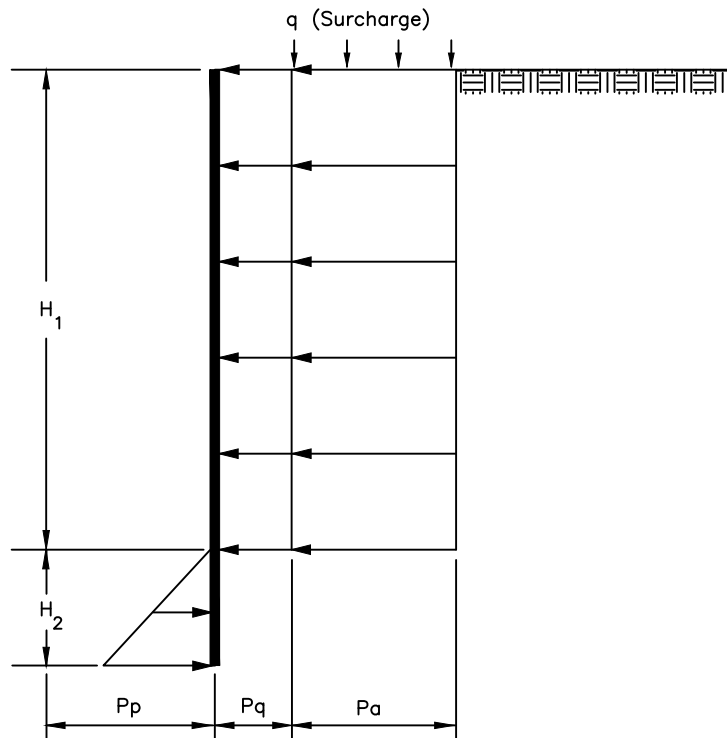

$$P = P_q + P_a$$

$$= 0.5q + 27H_1 \text{ (300 psf minimum)} - \text{active earth pressure}$$

$$P_p = 240 H_2 \leq 2500 \text{ psf} - \text{passive earth pressure (on native or compacted soils)}$$

$$\mu = 0.34 - \text{allowable friction coefficient between concrete and soil}$$

Notes:

1. All values of height (H) in feet, pressure (P) and surcharge (q) in pounds per square foot (psf).
2. P_p and P_a are the passive and active earth pressure respectively; P_q is the incremental surcharge earth pressure; and μ is the allowable friction coefficient, applied to dead normal loads acting on non-pile supported elements.
3. Earth pressures assume no hydrostatic pressures. If hydrostatic pressures are allowed to build up, the incremental earth pressures below the ground-water level should be reduced by 50 percent and added to hydrostatic pressure for total lateral pressure.
4. P_p includes a safety factor of 1.5.
5. Neglect the upper 1 foot for passive pressure unless the surface is confined by a pavement of slab.
6. For traffic surcharge, use a uniform pressure of 100 psf over the top 10 feet.

RECOMMENDED LATERAL EARTH PRESSURE FOR BRACED EXCAVATION

OCWD PFAS Treatment Facility
Orange Park Acres Well No. 1 Wellhead Facilities
678 N. Gravier Street
City of Orange, California

Project No.
20-32-172-01



Converse Consultants

Drawing No.
7

verify compliance with project specifications. Additional geotechnical recommendations may be required based on subsurface conditions encountered during construction.

12.0 CLOSURE

This report is prepared for the project described herein and is intended for use solely by AECOM, Irvine Ranch Water District (IRWD), and their authorized agents for design purposes. Our findings and recommendations were obtained in accordance with generally accepted professional principles practiced in geotechnical engineering. We make no other warranty, either expressed or implied.

Converse Consultants is not responsible or liable for any claims or damages associated with interpretation of available information provided to others. Site exploration identifies actual soil conditions only at those points where samples are taken, when they are taken. Data derived through sampling and laboratory testing is extrapolated by Converse employees who render an opinion about the overall soil conditions. Actual conditions in areas not sampled may differ. In the event that changes to the project occur, or additional, relevant information about the project is brought to our attention, the recommendations contained in this report may not be valid unless these changes and additional relevant information are reviewed and the recommendations of this report are modified or verified in writing. In addition, the recommendations can only be finalized by observing actual subsurface conditions revealed during construction. Converse cannot be held responsible for misinterpretation or changes to our recommendations made by others during construction.

As the project evolves, continued consultation and construction monitoring by a qualified geotechnical consultant should be considered an extension of geotechnical investigation services performed to date. The geotechnical consultant should review plans and specifications to verify that the recommendations presented herein have been appropriately interpreted, and that the design assumptions used in this report are valid. Where significant design changes occur, Converse may be required to augment or modify the recommendations presented herein. Subsurface conditions may differ in some locations from those encountered in the explorations, and may require additional analyses and, possibly, modified recommendations.

Design recommendations given in this report are based on the assumption that the recommendations contained in this report are implemented. Additional consultation may be prudent to interpret Converse's findings for contractors, or to possibly refine these recommendations based upon the review of the actual site conditions encountered during construction. If the scope of the project changes, if project completion is to be delayed, or if the report is to be used for another purpose, this office should be consulted.



13.0 REFERENCES

- AMERICAN CONCRETE INSTITUTE (ACI), 2014, Building Code Requirements for Structural Concrete (ACI 318-14) and Commentary, October 2014.
- AMERICAN SOCIETY OF CIVIL ENGINEERS (ASCE), 2016, Minimum Design Loads for Buildings and Other Structures, SEI/ASCE Standard No. 7-16, dated January 1, 2016.
- ASTM INTERNATIONAL, Annual Book of ASTM Standards, Current.
- BOORE, D.M., 2004, Estimating Vs(30) (or NEHRP Site Classes) from Shallow Velocity Models (Depths < 30m), Bulletin of Seismological Society of America, 94 (2), pp. 591-597.
- BOULANGER, R.W. AND IDRIS, I.M., 2014, CPT and SPT Based Liquefaction Triggering Procedures, University of California Davis, Center for Geotechnical Modeling Report No. UCD/CGM-14/01, 1-134.
- BRANDENBERG, S.J., BELLANA, N. and SHANTZ, T., 2010, Shear Wave Velocity as a Statistical Function of Standard Penetration Test Resistance and Vertical Effective Stress at Caltrans Bridge Sites, PEER Report 201/03.
- CALIFORNIA BUILDING STANDARDS COMMISSION (CBSC), 2019, California Building Code (CBC).
- CALIFORNIA DEPARTMENT OF TRANSPORTATION (Caltrans), 2017, Highway Design Manual, dated November 20, 2017.
- CALIFORNIA DEPARTMENT OF TRANSPORTATION (Caltrans), 1986, Method for Determining the Percolation Rate of Soils Using a 6-Inch-Diameter Test Hole, California Test 750, dated 1986.
- CALIFORNIA DEPARTMENT OF WATER RESOURCES (DWR), 2019, Dam Breach Inundation Map Web Publisher (https://fmds.water.ca.gov/webgis/?appid=dam_prototype_v2), accessed May 2019.
- CALIFORNIA GEOLOGICAL SURVEY (CGS), (formerly California Division of Mines and Geology), 1997, Seismic Hazard Zone Report for the Orange 7.5-minute Quadrangle, Orange County, California, Seismic Hazard Zone Report 11, dated 1997.
- CALIFORNIA GEOLOGICAL SURVEY (CGS) (formerly California Division of Mines and Geology), T. Topozada, D. Branum, M. Petersen, C. Hallstrom, C. Cramer, M. Rechle, 2000, Map Sheet 49, Epicenters of and Areas Damaged by $M \geq 5$ California Earthquakes, 1800-1999, scale varies, dated December 2000.
- CALIFORNIA GEOLOGICAL SURVEY (CGS), 2007, Fault-Rupture Hazard Zones in California, Alquist-Priolo Earthquake Faulting Zoning Act with Index to Earthquake Fault Zone Maps, Special Publication 42, revised 2007.



- CALIFORNIA GEOLOGICAL SURVEY (CGS), 2008, Guidelines for Evaluating and Mitigating Seismic Hazards in California, Special Publication 117A, dated September 11, 2008.
- CALIFORNIA GEOLOGICAL SURVEY (CGS), 2013, Note 48, Checklist for the Review of Engineering Geology and Seismology Reports for California Public Schools, Hospitals, and Essential Services Structures, dated October 2013.
- DAS, B.M., 2011, Principles of Foundation Engineering, Seventh Edition, published by Global Engineering, 2011.
- FEDERAL EMERGENCY MANAGEMENT AGENCY (FEMA), 2009, Flood Insurance Rate Map, Orange County, California and Incorporated Areas, Map No. 06059C259J, dated December 3, 2009.
- GEOTECHNICAL INVESTIGATION REPORT Orange Park Acres Well No. 1 Wellhead Facilities, Southwest of the Intersection of East Bond Avenue and North Gravier Street, City of Orange, Orange County, California. Converse Project No. 11-32-113-01, dated August 2, 2012.
- INFRAGEO SOFTWARE, 2015-2020, EPRESS: Analysis of Lateral Earth Loads and Resistance on a Retaining Wall.
- INFRAGEO SOFTWARE, 2015-2020, FTGCAP: Analysis of Bearing Capacity of a Rectangular Spread Footing.
- INFRAGEO SOFTWARE, 2015-2020, SPTLIQ: Simplified Liquefaction Hazards Assessment Using Standard Penetration Test (SPT) Data.
- INFRAGEO SOFTWARE, 2015-2020, SPTPROP: Simplified Evaluation of Site Class and Geotechnical Design Using Standard Penetration Test (SPT) Data.
- ISHIHARA, K. AND YOSHIMINE, M., 1992, Evaluation of Settlements in Sand Deposits Following Liquefaction During Earthquakes, Soils and Foundation, Japanese Geotechnical Society, 32 (1), pp. 173-188.
- MIKOLA, R.G. and SITAR, N., 2013, Seismic Earth Pressures on Retaining Structures in Cohesionless Soils, UC Berkeley Dept. of Civil and Env. Eng. Report No. UCB GT 13-01, March 2013.
- MORTON, D.M. and MILLER, F.K., 2006, Geologic Map of the San Bernardino and Santa Ana 30' x 60' Quadrangles, California, U.S. Geological Survey Open-File Report 2006-1217, scale 1:100,000.
- NINYO & MOORE, 2014, Updated Geotechnical Evaluation, Rancho Santiago Community College District, Orange Education Center Seismic Rehabilitation, dated September 16, 2014, Project No. 206144014.



ORANGE COUNTY WATERSHEDS PROGRAM (OCWP), 2013, Technical Guidance Document for the Preparation of Conceptual/Preliminary and/or Project Water Quality Management Plans, dated December 20, 2013.

PRADEL, D., 1998, Procedures to Evaluate Earthquake-Induced Settlements in Dry Sandy Soils, Journal of Geotechnical Engineering, ASCE 124 (4), pp. 364-368.

PUBLIC WORKS STANDARDS, INC., 2018, Standard Specifications for Public Works Construction (“Greenbook”), 2018.

ROMANOFF, MELVIN, 1957, Underground Corrosion, National Bureau of Standards Circular 579, dated April 1957.

UNITED STATES GEOLOGIC SURVEY, 2008 National Seismic Hazard Maps – Source Parameters, https://earthquake.usgs.gov/cfusion/hazfaults_2008_search.



GEOTECHNICAL INVESTIGATION

Appendix A

Field Exploration

APPENDIX A: FIELD EXPLORATION

Our field investigation included a site reconnaissance and a subsurface exploration program consisting of drilling soil borings. During the site reconnaissance, the surface conditions were noted, and the approximate locations of the test borings were established by reference to existing site and boundary features. The mapped locations should be considered accurate only to the degree implied by the method used to locate the borings in the field. The field exploration procedures is discussed in the following sections.

A.1 Exploratory Borings

To investigate the subsurface conditions at the project site, two (2) exploratory borings (BH-1 and BH-2) were drilled on February 25, 2021 to depth of 26.5 feet below ground surface (bgs). The approximate locations of the borings are shown on Drawing No. 2, *Boring Location Map*.

The borings were advanced using a truck-mounted drill rig equipped with 8-inch diameter hollow-stem augers for soils sampling. Encountered materials were continuously logged by a Converse geologist and classified in the field by visual classification in accordance with the Unified Soil Classification System. Where appropriate, the field descriptions and classifications have been modified to reflect laboratory test results.

Relatively undisturbed samples were obtained using California Modified Samplers (2.4 inches inside diameter and 3.0 inches outside diameter) lined with thin sample rings. The steel ring sampler was driven into the bottom of the borehole with successive drops of a 140-pound driving weight falling 30 inches. Blow counts at each sample interval are presented on the boring logs. Samples were retained in brass rings (2.4 inches inside diameter and 1.0 inch in height) and carefully sealed in waterproof plastic containers for shipment to the Converse laboratory. Bulk samples of typical soil types were also obtained.

Standard Penetration Testing (SPT) was performed in accordance with the ASTM Standard D1586 test method at 25 feet bgs in boring BH-2 using a standard (1.4 inches inside diameter and 2.0 inches outside diameter) split-barrel sampler. The mechanically driven hammer for the SPT sampler was 140 pounds, falling 30 inches for each blow. The recorded blow counts for every 6 inches for a total of 1.5 feet of sampler penetration are shown on the Logs of Borings.

The exact depths at which material changes occur cannot always be established accurately. Unless a more precise depth can be established by other means, changes in material conditions that occur between drive samples are indicated on the logs at the top of the next drive sample.



Following the completion of logging and sampling, the borings were backfilled with soil cuttings and compacted by pushing down with augers using drill rig weight. If construction is delayed, the surface may settle over time. Therefore, we recommend the owner monitor the boring locations and backfill any depressions that might occur or provide protection around the boring locations to prevent trip and fall injuries from occurring near the area of any potential settlement.

For a key to soil symbols and terminology used in the boring logs, refer to Drawing No. A-1 and A-2, *Unified Soil Classification and Key to Boring Log Symbols*. For logs of borings, see Drawing Nos. A-3 and A-4, *Logs of Borings*.



SOIL CLASSIFICATION CHART

MAJOR DIVISIONS			SYMBOLS		TYPICAL DESCRIPTIONS
			GRAPH	LETTER	
COARSE GRAINED SOILS	GRAVEL AND GRAVELLY SOILS	CLEAN GRAVELS (LITTLE OR NO FINES)		GW	WELL-GRADED GRAVELS, GRAVEL - SAND MIXTURES, LITTLE OR NO FINES
		GRAVELS WITH FINES (APPRECIABLE AMOUNT OF FINES)		GP	POORLY-GRADED GRAVELS, GRAVEL - SAND MIXTURES, LITTLE OR NO FINES
	SAND AND SANDY SOILS	CLEAN SANDS (LITTLE OR NO FINES)		GM	SILTY GRAVELS, GRAVEL - SAND - SILT MIXTURES
				GC	CLAYEY GRAVELS, GRAVEL - SAND - CLAY MIXTURES
		SANDS WITH FINES (APPRECIABLE AMOUNT OF FINES)		SW	WELL-GRADED SANDS, GRAVELLY SANDS, LITTLE OR NO FINES
				SP	POORLY-GRADED SANDS, GRAVELLY SAND, LITTLE OR NO FINES
FINE GRAINED SOILS	SILTS AND CLAYS	LIQUID LIMIT LESS THAN 50		SM	SILTY SANDS, SAND - SILT MIXTURES
				SC	CLAYEY SANDS, SAND - CLAY MIXTURES
				ML	INORGANIC SILTS AND VERY FINE SANDS, ROCK FLOUR, SILTY OR CLAYEY FINE SANDS OR CLAYEY SILTS WITH SLIGHT PLASTICITY
	SILTS AND CLAYS	LIQUID LIMIT GREATER THAN 50		CL	INORGANIC CLAYS OF LOW TO MEDIUM PLASTICITY, GRAVELLY CLAYS, SANDY CLAYS, SILTY CLAYS, LEAN CLAYS
				OL	ORGANIC SILTS AND ORGANIC SILTY CLAYS OF LOW PLASTICITY
				MH	INORGANIC SILTS, MICACEOUS OR DIATOMACEOUS FINE SAND OR SILTY SOILS
HIGHLY ORGANIC SOILS				CH	INORGANIC CLAYS OF HIGH PLASTICITY
				OH	ORGANIC CLAYS OF MEDIUM TO HIGH PLASTICITY, ORGANIC SILTS
				PT	PEAT, HUMUS, SWAMP SOILS WITH HIGH ORGANIC CONTENTS

FIELD AND LABORATORY TESTS	
C	Consolidation (ASTM D 2435)
CL	Collapse Potential (ASTM D 4546)
CP	Compaction Curve (ASTM D 1557)
CR	Corrosion, Sulfates, Chlorides (CTM 643-99; 417; 422)
CU	Consolidated Undrained Triaxial (ASTM D 4767)
DS	Direct Shear (ASTM D 3080)
EI	Expansion Index (ASTM D 4829)
M	Moisture Content (ASTM D 2216)
OC	Organic Content (ASTM D 2974)
P	Permeability (ASTM D 2434)
PA	Particle Size Analysis (ASTM D 6913 [2002])
PI	Liquid Limit, Plastic Limit, Plasticity Index (ASTM D 4318)
PL	Point Load Index (ASTM D 5731)
PM	Pressure Meter
PP	Pocket Penetrometer
R	R-Value (CTM 301)
SE	Sand Equivalent (ASTM D 2419)
SG	Specific Gravity (ASTM D 854)
SW	Swell Potential (ASTM D 4546)
TV	Pocket Torvane
UC	Unconfined Compression - Soil (ASTM D 2166)
	Unconfined Compression - Rock (ASTM D 7012)
UU	Unconsolidated Undrained Triaxial (ASTM D 2850)
UW	Unit Weight (ASTM D 2937)

NOTE: DUAL SYMBOLS ARE USED TO INDICATE BORDERLINE SOIL CLASSIFICATIONS

BORING LOG SYMBOLS

DRILLING METHOD SYMBOLS			
	Auger Drilling		Mud Rotary Drilling
	Dynamic Cone or Hand Driven		Diamond Core

SAMPLE TYPE

- STANDARD PENETRATION TEST
Split barrel sampler in accordance with ASTM D-1586-84 Standard Test Method
- DRIVE SAMPLE 2.42" I.D. sampler (CMS).
- DRIVE SAMPLE No recovery
- BULK SAMPLE
- GROUNDWATER WHILE DRILLING
- GROUNDWATER AFTER DRILLING

UNIFIED SOIL CLASSIFICATION AND KEY TO BORING LOG SYMBOLS



Converse Consultants

OCWD PFAS Treatment Facility
Orange Park Acres Well No. 1 Wellhead Facilities
678 N. Gravier Street
City of Orange, California

Project No.
20-32-172-01

Drawing No.
A-1

CONSISTENCY OF COHESIVE SOILS

Descriptor	Unconfined Compressive Strength (tsf)	SPT Blow Counts	Pocket Penetrometer (tsf)	CA Sampler	Torvane (tsf)	Field Approximation
Very Soft	<0.25	< 2	<0.25	<3	<0.12	Easily penetrated several inches by fist
Soft	0.25 - 0.50	2 - 4	0.25 - 0.50	3 - 6	0.12 - 0.25	Easily penetrated several inches by thumb
Medium Stiff	0.50 - 1.0	5 - 8	0.50 - 1.0	7 - 12	0.25 - 0.50	Can be penetrated several inches by thumb with moderate effort
Stiff	1.0 - 2.0	9 - 15	1.0 - 2.0	13 - 25	0.50 - 1.0	Readily indented by thumb but penetrated only with great effort
Very Stiff	2.0 - 4.0	16 - 30	2.0 - 4.0	26 - 50	1.0 - 2.0	Readily indented by thumbnail
Hard	>4.0	>30	>4.0	>50	>2.0	Indented by thumbnail with difficulty

APPARENT DENSITY OF COHESIONLESS SOILS

Descriptor	SPT N ₆₀ Value (blows / foot)	CA Sampler
Very Loose	<4	<5
Loose	4- 10	5 - 12
Medium Dense	11 - 30	13 - 35
Dense	31 - 50	36 - 60
Very Dense	>50	>60

MOISTURE

Descriptor	Criteria
Dry	Absence of moisture, dusty, dry to the touch
Moist	Damp but no visible water
Wet	Visible free water, usually soil is below water table

PERCENT OF PROPORTION OF SOILS

Descriptor	Criteria
Trace (fine)/ Scattered (coarse)	Particles are present but estimated to be less than 5%
Few	5 to 10%
Little	15 to 25%
Some	30 to 45%
Mostly	50 to 100%

SOIL PARTICLE SIZE

Descriptor	Size	
Boulder	> 12 inches	
Cobble	3 to 12 inches	
Gravel	Coarse	3/4 inch to 3 inches
	Fine	No. 4 Sieve to 3/4 inch
Sand	Coarse	No. 10 Sieve to No. 4 Sieve
	Medium	No. 40 Sieve to No. 10 Sieve
	Fine	No. 200 Sieve to No. No. 40 Sieve
Silt and Clay	Passing No. 200 Sieve	

PLASTICITY OF FINE-GRAINED SOILS

Descriptor	Criteria
Nonplastic	A 1/8-inch thread cannot be rolled at any water content.
Low	The thread can barely be rolled, and the lump cannot be formed when drier than the plastic limit.
Medium	The thread is easy to roll, and not much time is required to reach the plastic limit; it cannot be rerolled after reaching the plastic limit. The lump crumbles when drier than the plastic limit.
High	It takes considerable time rolling and kneading to reach the plastic limit. The thread can be rerolled several times after reaching the plastic limit. The lump can be formed without crumbling when drier than the plastic limit.

CEMENTATION/ Induration

Descriptor	Criteria
Weak	Crumbles or breaks with handling or little finger pressure.
Moderate	Crumbles or breaks with considerable finger pressure.
Strong	Will not crumble or break with finger pressure.

NOTE: This legend sheet provides descriptions and associated criteria for required soil description components only. Refer to Caltrans Soil and Rock Logging, Classification, and Presentation Manual (2010), Section 2, for tables of additional soil description components and discussion of soil description and identification.

UNIFIED SOIL CLASSIFICATION AND KEY TO BORING LOG SYMBOLS















Log of Boring No. BH-1

Dates Drilled: 2/25/2021 Logged by: Karley Sullivan Checked By: Babak Abbasi

Equipment: 8" HOLLOW STEM AUGER Driving Weight and Drop: 140 lbs / 30 in

Ground Surface Elevation (ft): 290 Depth to Water (ft): NOT ENCOUNTERED

Depth (ft)	Graphic Log	SUMMARY OF SUBSURFACE CONDITIONS <small>This log is part of the report prepared by Converse for this project and should be read together with the report. This summary applies only at the location of the boring and at the time of drilling. Subsurface conditions may differ at other locations and may change at this location with the passage of time. The data presented is a simplification of actual conditions encountered.</small>	SAMPLES		BLOWS/6"	MOISTURE (%)	DRY UNIT WT. (pcf)		
			DRIVE	BULK					
		0.5 INCHES OF CRUSHED ROCK						PA (fc=6.3%) CR	
		FILL (Af) POORLY GRADED GRAVEL WITH SILT (GP-GM): fine to coarse-grained, few cobbles up to 4 inches in largest dimension, light brown.							
5		ALLUVIUM (Qal): POORLY GRADED GRAVEL (GP): fine to coarse-grained, few cobbles with up to 4 inches in largest dimension, dense, grayish brown. *chatter			13/22/24	3	115		
10		trace silt			50/6"	3	99		
15		some cobbles with up to 5 inches in largest dimension			50/26	1	115	DS	
20		NO RECOVERY *chatter end's, fines increase			19/23/21				
25		SILTY SAND (SM): fine-grained, few gravels, very dense, orange brown.			11/32/35	17	104	CL	
		End of boring at 26.5 feet below ground surface Groundwater was not encountered Boring was backfilled with soil cuttings on 2/25/2021.							



Converse Consultants

Project Name
OCWD PFAS Treatment Facility
Orange Park Acres Well No. 1 Wellhead Facilities
678 N. Gravier Street
City of Orange, California

Project No.
20-32-172-01













Drawing No.
A-3

Log of Boring No. BH-2

Dates Drilled: 2/25/2021 Logged by: Karley Sulliva Checked By: Babak Abbasi

Equipment: 8" HOLLOW STEM AUGER Driving Weight and Drop: 140 lbs / 30 in

Ground Surface Elevation (ft): 290 Depth to Water (ft): NOT ENCOUNTERED

Depth (ft)	Graphic Log	SUMMARY OF SUBSURFACE CONDITIONS <small>This log is part of the report prepared by Converse for this project and should be read together with the report. This summary applies only at the location of the boring and at the time of drilling. Subsurface conditions may differ at other locations and may change at this location with the passage of time. The data presented is a simplification of actual conditions encountered.</small>	SAMPLES		BLOWS/6"	MOISTURE (%)	DRY UNIT WT. (pcf)	
			DRIVE	BULK				
5		0.5 INCHES OF CRUSHED ROCK <u>FILL (Af):</u> POORLY GRADED GRAVEL WITH SILT (GP-GM): fine to coarse-grained, few cobbles with up to 4 inches in largest dimension, light brown. *chatter				2	117	CP
10		<u>ALLUVIUM (Qal):</u> POORLY GRADED GRAVEL (GP): fine to coarse-grained, few cobbles with up to 4 inches in largest dimension, very dense, light gray-brown. heavy chatter NO RECOVERY			16/31/31			
15		NO RECOVERY no recovery due to large cobbles up to 5 inches in largest dimension			17/20/21			
20		SILTY SAND (SM): fine-grained, medium dense, orange brown.			50@1"			
25					20/16/7	11	118	DS
26.5		End of boring at 26.5 feet below ground surface. Groundwater was not encountered. Boring was backfilled with soil cuttings on 2/25/2021.			4/8/24			PI



Converse Consultants

Project Name
 OCWD PFAS Treatment Facility
 Orange Park Acres Well No. 1 Wellhead Facilities
 678 N. Gravier Street
 City of Orange, California

Project No. Drawing No.
 20-32-172-01 A-4

GEOTECHNICAL INVESTIGATION

Appendix B

Laboratory Testing Program

APPENDIX B: LABORATORY TESTING PROGRAM

Tests were conducted in our laboratory on representative soil samples for the purpose of classification and evaluation of their relevant physical characteristics and engineering properties. The amount and selection of tests were based on the geotechnical requirements of the project. Summaries of the various laboratory tests conducted for this project and test results are presented below.

B.1 Moisture Content and Dry Density

In-situ dry density and moisture content tests were performed on relatively undisturbed ring samples in accordance with ASTM Standard D2216 and D7263 test method. This test is used in soil classification and provides qualitative information on strength and compressibility characteristics of site soils. For test results, see the Logs of Borings in Appendix A, *Field Exploration*.

B.2 Soil Corrosivity

one representative soil sample was tested to determine minimum electrical resistivity, pH, and chemical content, including soluble sulfate and chloride concentrations. The purpose of these tests was to determine the corrosion potential of site soils when placed in contact with common construction materials. These tests were performed by EG Lab, Inc. (Arcadia, CA) in accordance with CTM 643, 422, and 417. Test results are presented in the table below.

Table No. B-1, Summary of Soil Corrosivity Test Results

Boring No.	Depth (feet)	pH	Chloride (ppm)	Sulfate (% by weight)	Minimum Electrical Resistivity (Ohm-cm)
BH-1	0.5-3.0	8.19	210	0.003	7,200

B.3 Grain Size Analyses

To aid in classification of the soils, mechanical grain-size analysis was performed on one representative soil sample. Testing was performed in accordance with the ASTM Standard D6913 test method. For test result, see Drawing No. B-1, *Grain Size Distribution Result*.

B.4 Atterberg Limits

Atterberg limits tests were performed on one (1) sample to assist the classification of the soil and fill materials according to ASTM Standard D4318 test method. The test results are presented in the following table and on Drawing No. B-2, *Atterberg Limits Results*.



Table No. B-2 Atterberg Limit Test Results

Boring No.	Depth (feet)	Soil Classification	Liquid Limit (%)	Plastic Limit (%)	Plastic Index (%)
BH-2	25.0-26.5	Silt (ML)	28	24	4

B.5 Maximum Density and Optimum Moisture Content

Laboratory maximum dry density-optimum moisture content relationship tests were performed on one (1) representative bulk sample. The test was conducted in accordance with the ASTM Standard D1557 test method. The test results are presented in Drawing No. B-3, *Moisture-Density Relationship Results*, and are also summarized in the following table.

Table No B-3, Summary of Moisture-Density Relationship Results

Boring No.	Depth (feet)	Soil Description	Optimum Moisture (%)	Maximum Dry Density (lb/cft)
BH-2	0.0-5.0	Poorly Graded Gravel with silt (GP-GM)	6.7	131

B.6 Direct Shear

Two direct shear tests were performed on representative undisturbed soil samples in accordance with ASTM D3080. For each test, three ring samples were tested at soaked moisture conditions. The samples were placed, one at a time, directly into the test apparatus and subjected to a range of normal loads appropriate for the anticipated conditions. Depending on the soil type, each sample was then sheared at a constant strain rate between 0.004 and 0.02 inch/minute. Shear deformation was recorded until a maximum of about 0.25-inch shear displacement was achieved. Ultimate strength was selected from the shear-stress vs. deformation data and plotted to determine the shear strength parameters. For test data, including sample density and moisture content, see Drawing No. B-4, *Direct Shear Test Results*, and the summary table below.

Table No. B-4, Summary of Direct Shear Test Result

Boring No.	Depth (feet)	Soil Description	Ultimate Strength Parameters	
			Friction Angle (degrees)	Cohesion (psf)
BH-1	15.0-16.5	Poorly Graded Gravel (GP)	33	0
BH-2	20.0-21.5	Silty Sand (SM)	26	100

B.7 Collapse Tests

To evaluate the moisture sensitivity (collapse/swell potential) of the encountered soils, collapse test was performed in accordance with the ASTM Standard D4546 laboratory procedure. Sample was loaded to approximately 2 kips per square foot (ksf), allowed to



stabilize under load, and then submerged. The test results are presented in Drawing No. B-5, *Swell/Collapse Test Result*, and in the following table.

Table No. B-5, Collapse Test Result

Boring No.	Depth (feet)	Soil Classification	Percent Swell + Percent Collapse -	Collapse Potential
BH-1	25.0-26.5	Silty Sand (SM)	0.0 %	None

B.8 Sample Storage

Soil samples stored in our laboratory will be discarded 30 days after the date of this report, unless this office receives a specific request to retain the samples for a longer period.



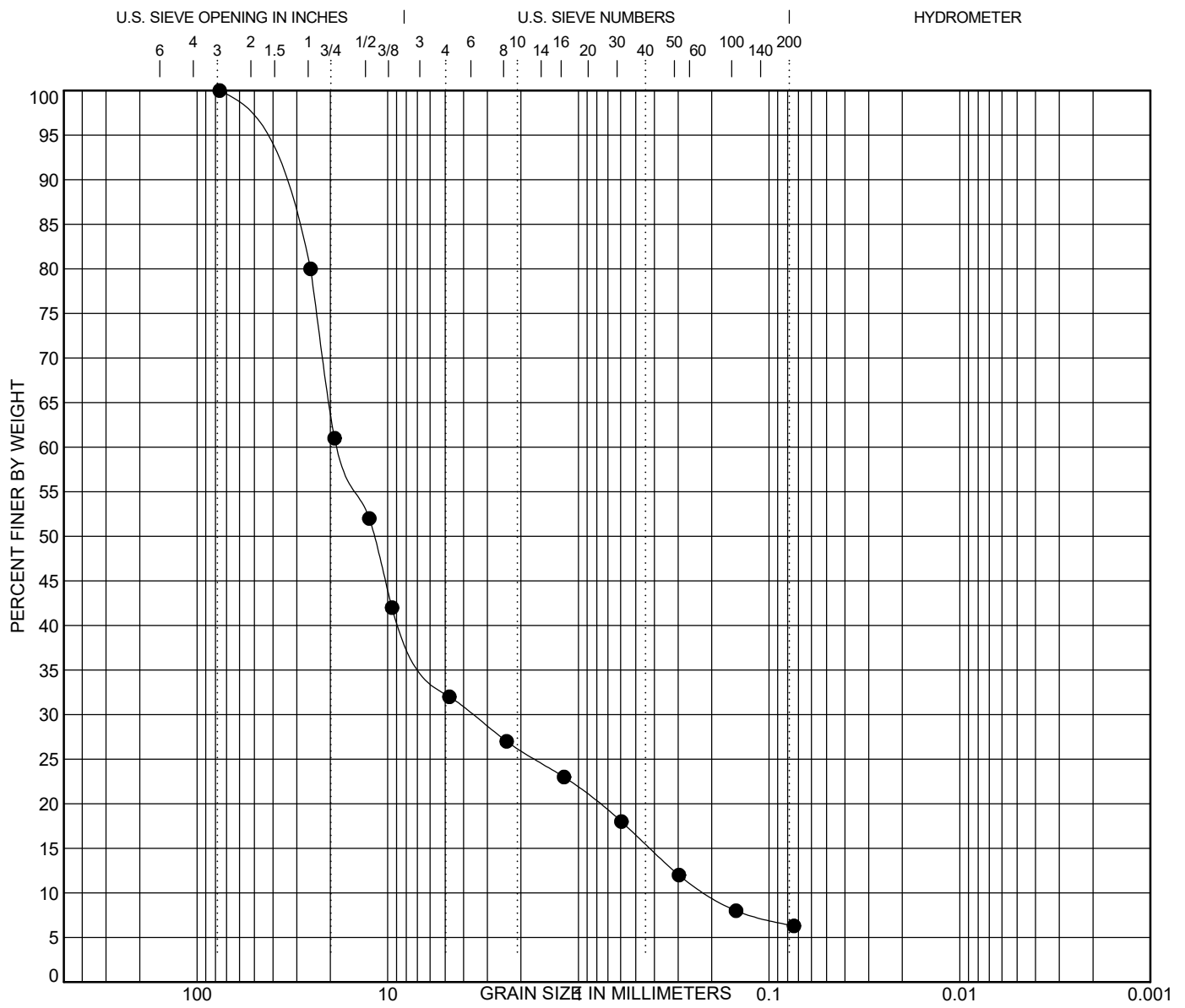

COBBLES	GRAVEL		SAND			SILT OR CLAY
	coarse	fine	coarse	medium	fine	

Boring No.	Depth (ft)	Description					LL	PL	PI	Cc	Cu
● BH-1	0.5-3.0	Poorly Graded Gravel with silt (GP-GM)								3.40	86.21
Boring No.	Depth (ft)	D100	D60	D30	D10	%Gravel	%Sand	%Silt	%Clay		
● BH-1	0.5-3.0	76.2	18.136	3.603	0.21	67.7	25.7	6.3			

GRAIN SIZE DISTRIBUTION RESULTS



Converse Consultants

Project Name
 OCWD PFAS Treatment Facility
 Orange Park Acres Well No. 1 Wellhead Facilities
 678 N. Gravier Street
 City of Orange, California

Project No.
 20-32-172-01

Figure No.

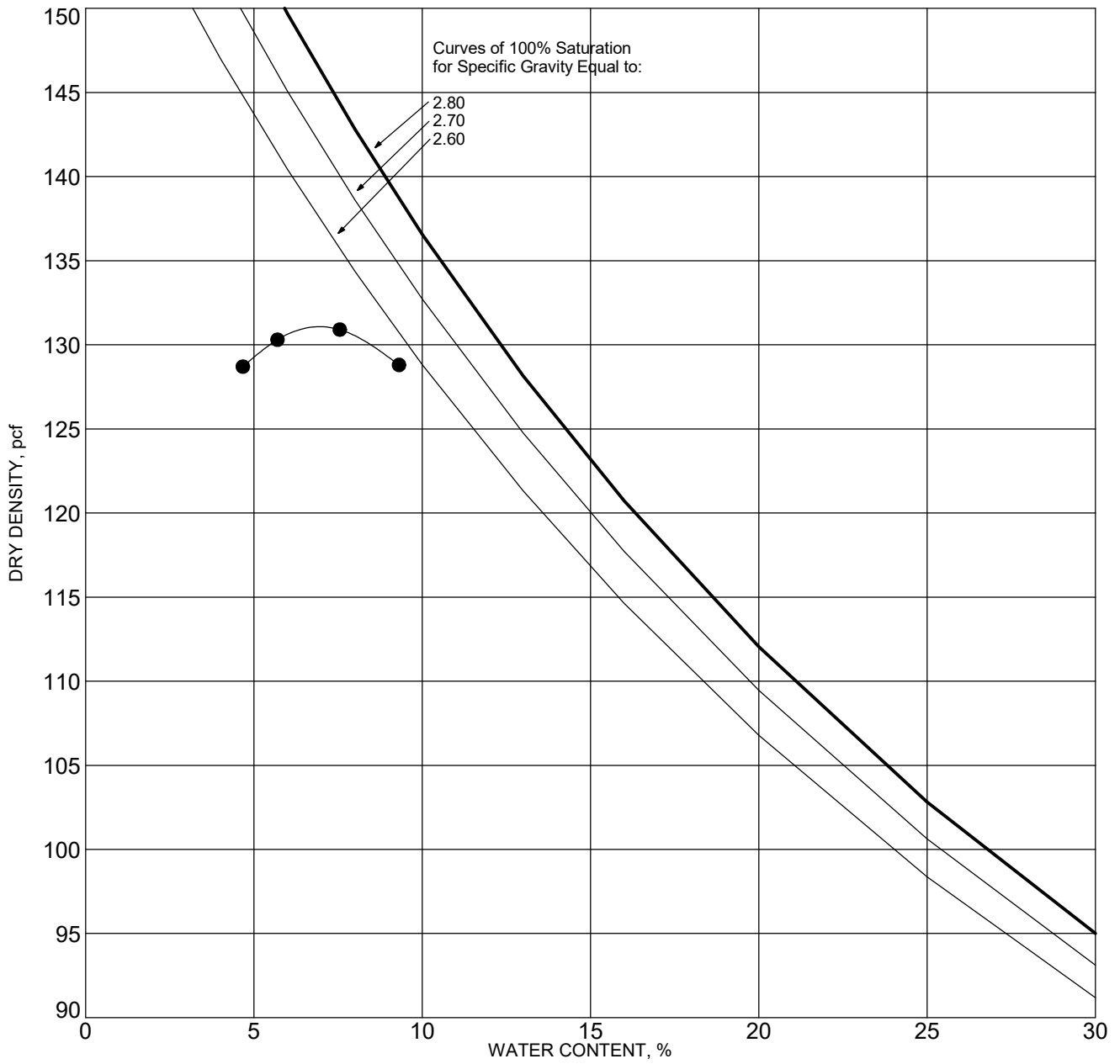

SYMBOL	BORING NO.	DEPTH (ft)	DESCRIPTION	ASTM TEST METHOD	OPTIMUM WATER, %	MAXIMUM DRY DENSITY, pcf
●	BH-2	0-5	Poorly Graded Gravel with silt (GP-GM), light brown	D1557 Method B	6.7	131

NOTE:

MOISTURE-DENSITY RELATIONSHIP RESULTS



Converse Consultants

Project Name
 OCWD PFAS Treatment Facility
 Orange Park Acres Well No. 1 Wellhead Facilities
 678 N. Gravier Street
 City of Orange, California

Project No.
 20-32-172-01

Drawing No.
 B-3

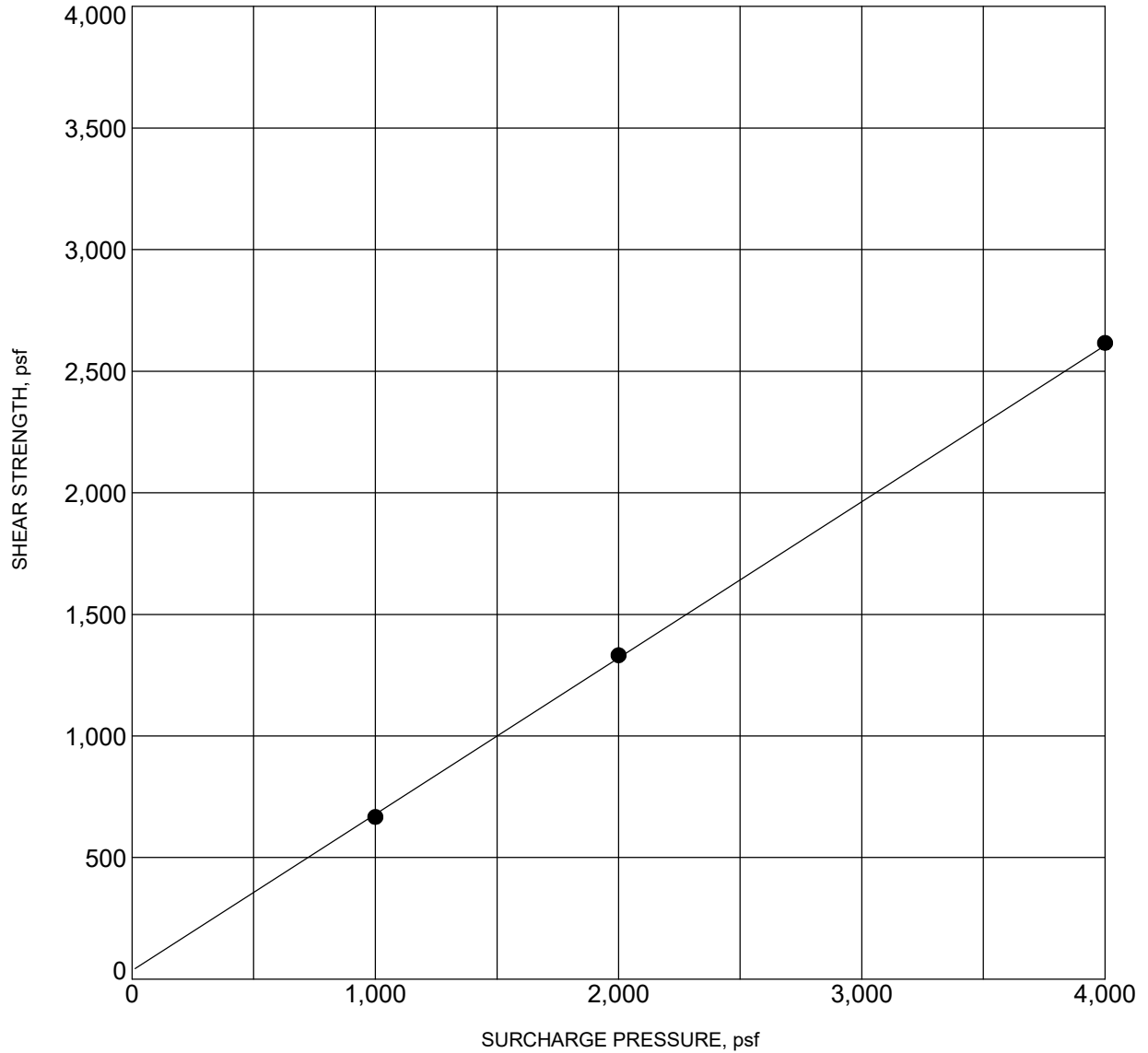

BORING NO. :	BH-1	DEPTH (ft) :	15.0-16.5
DESCRIPTION :	Poorly Graded Gravel (GP)		
COHESION (psf) :	0	FRICTION ANGLE (degrees):	33
MOISTURE CONTENT (%) :	1.0	DRY DENSITY (pcf) :	115.0

NOTE: Ultimate Strength.

DIRECT SHEAR TEST RESULTS



Converse Consultants

Project Name
 OCWD PFAS Treatment Facility
 Orange Park Acres Well No. 1 Wellhead Facilities
 678 N. Gravier Street
 City of Orange, California

Project No. Drawing No.
 20-32-172-01 B-4a

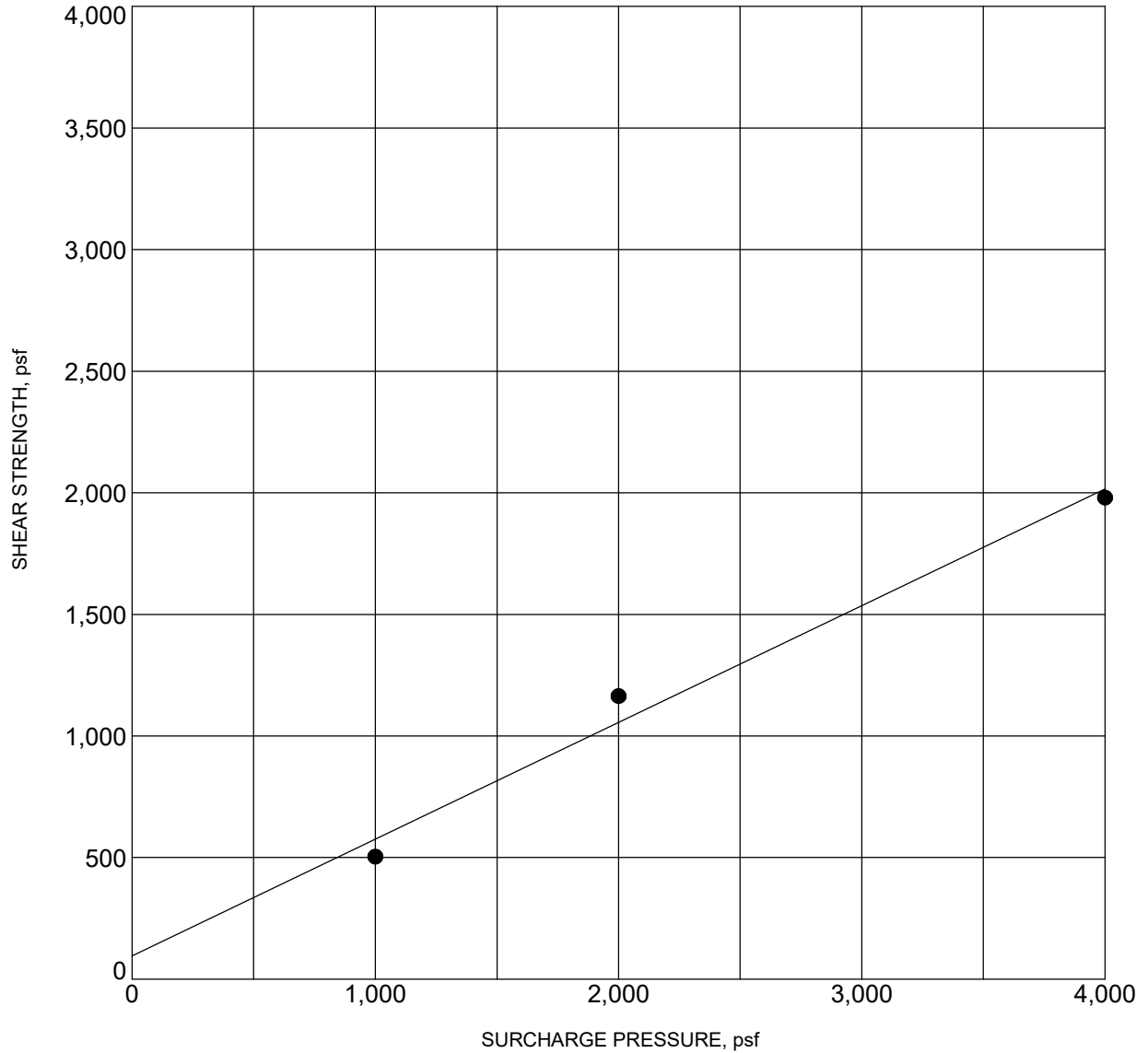

BORING NO. :	BH-2	DEPTH (ft) :	20.0-21.5
DESCRIPTION :	Silty Sand (SM)		
COHESION (psf) :	100	FRICTION ANGLE (degrees):	26
MOISTURE CONTENT (%) :	11.0	DRY DENSITY (pcf) :	118.1

NOTE: Ultimate Strength.

DIRECT SHEAR TEST RESULTS



Converse Consultants

Project Name
 OCWD PFAS Treatment Facility
 Orange Park Acres Well No. 1 Wellhead Facilities
 678 N. Gravier Street
 City of Orange, California

Project No. Drawing No.
 20-32-172-01 B4b

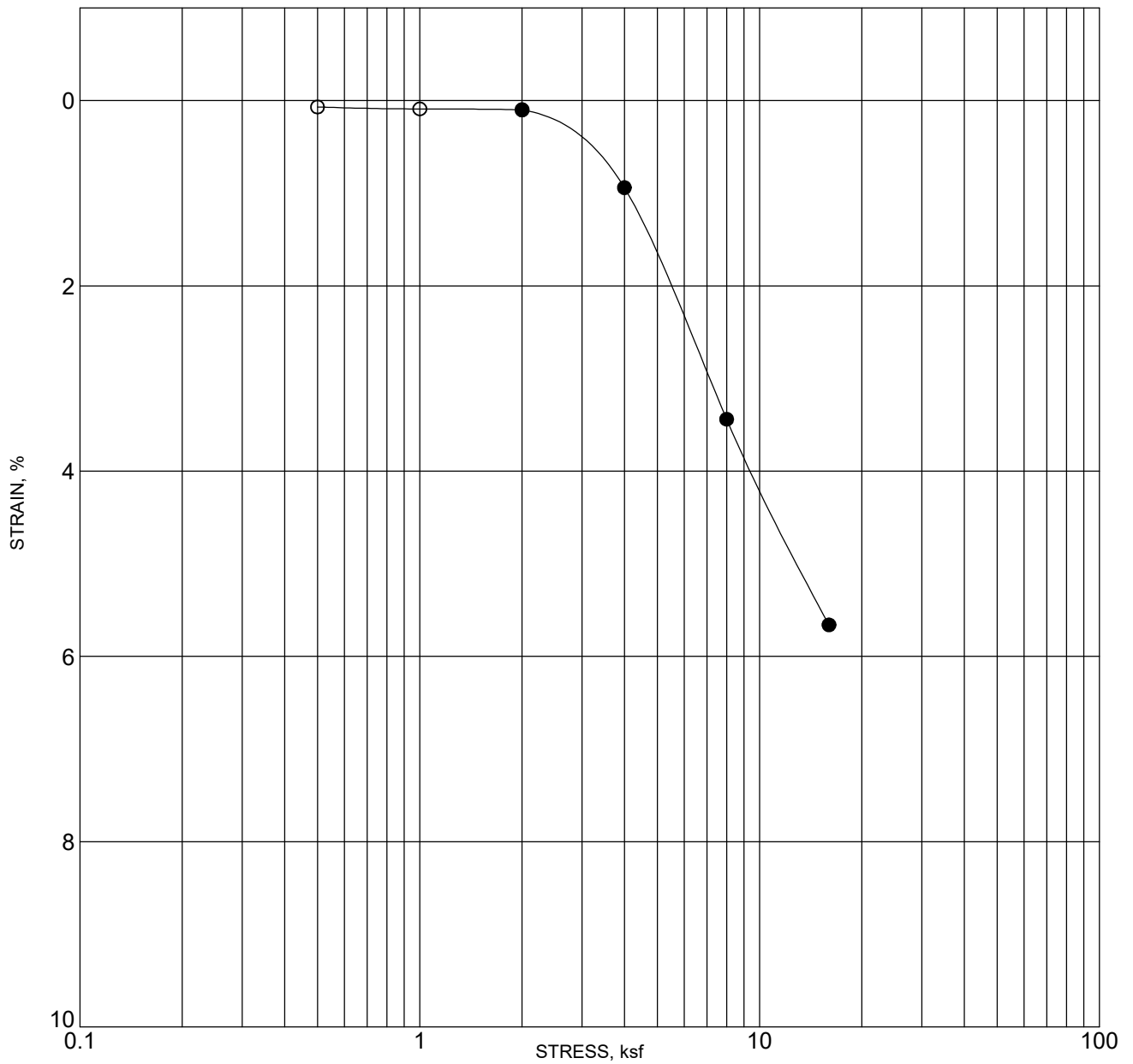

BORING NO. : BH-1		DEPTH (ft) : 25.0-26.5	
DESCRIPTION : Silty Sand (SM)			
MOISTURE CONTENT (%)	DRY DENSITY (pcf)	PERCENT SATURATION	VOID RATIO
INITIAL 17	104.0	77	0.740
FINAL			

NOTE: SOLID CIRCLES INDICATE READINGS AFTER ADDITION OF WATER

COLLAPSE/SWELL TEST RESULTS



Converse Consultants

Project Name
 OCWD PFAS Treatment Facility
 Orange Park Acres Well No. 1 Wellhead Facilities
 678 N. Gravier Street
 City of Orange, California

Project No. Drawing No.
 20-32-172-01 B-5

GEOTECHNICAL INVESTIGATION

Appendix C

Seismic Hazard Analysis Results



Site Class Determination



SIMPLIFIED EVALUATION OF SITE CLASS AND GEOTECHNICAL DESIGN PARAMETERS USING STANDARD PENETRATION TEST (SPT) DATA

(Copyright © 2015, 2020, SPTPROP, All Rights Reserved; By: InfraGEO Software)

PROJECT INFORMATION	
Project Name	OCWD PFAS Treatment Facility
Project No.	20-32-172-01
Project Location	678 N. Gravier Street, City of Orange, California
Analyzed By	B. Abbasi
Reviewed By	C. Amante
GENERAL INPUT DATA	
Analysis Description	
Boring ID No.	BH-3 (2012)
Ground Surface Elevation	294.00 feet
Proposed Grade Elevation	294.00 feet
Total Unit Weight of New Fill	120.00 pcf
Borehole Diameter	8.00 inches
Hammer Weight	140.00 pounds
Hammer Drop	30.00 inches
Hammer Efficiency Ratio, ER	80.00 %
Hammer Dist. to Ground Surface	5.00 feet
Groundwater Depth During Test	50.00 feet

SPT BLOW COUNT AND RELATIVE DENSITY
- Based on the recommendations by Idriss and Boulanger (2008), the normalized SPT blow count is defined as $(N_1)_{60} = N_{60} C_N$ where $N_{60} = N_{field} C_C C_B C_R C_S$
and the relative density of granular soils is estimated as $D_r = 15 [(N_1)_{60}]^{0.5}$ in percent

SOIL STRENGTH AND DEFORMATION MODULUS PARAMETERS
- For granular soils, the effective peak friction angle, ϕ' , is estimated from correlations with the normalized SPT blow count, $(N_1)_{60}$ from Bowles (1996) and recommended adjustments from Caltrans Geotechnical Manual (2014).
- For cohesive soils, the undrained shear strength, S_u , is based on field measurements with torvane or pocket penetrometer. When only SPT values are available, S_u is estimated using the correlation chart with $(N_1)_{60}$ value provided in the Caltrans Geotechnical Manual (2014).
- Modulus of Elasticity, E_s , values for granular soils and cohesive soils are estimated from correlations with SPT N_{60} and undrained shear strength, S_u , respectively summarized by Bowles (1996).
- Shear Modulus, $G = E_s / [3 (1 - 2\mu)]$ and Bulk Modulus, $K = E_s / [2 (1 + \mu)]$ based on theory of elasticity where μ is the Poisson's ratio of the soil. Typical values of Poisson's ratio are estimated from various references.

SHEAR WAVE VELOCITY AND SITE CLASSIFICATION
- Shear wave velocities are estimated based on empirical correlations with SPT N_{60} values for various soil types, as derived by Brandenberg, Bellana and Shantz (2010) from regression analyses.
- Site classification is analyzed using the method by Boore (2004). Ave. Shear Wave Velocity (Top Depth d), $V_{s,d} = 231.40 \text{ m/s}$ Ave. Shear Wave Velocity (Top 30 m), $V_{s,30} = 10^{a + b \log(V_{s,d})}$ where $a = 0.01380$ $b = 1.02630$
Coefficients a and b vary with depth, as derived by Boore (2004). Computed $V_{s,30} = 276.0 \text{ m/s}$ Site Class = D

REFERENCES:
1. AASHTO, 1988. Manual on Subsurface Investigations.
2. Boore, D.M., 2004. "Estimating Vs(30) (or NEHRP Site Classes) from shallow velocity models (depths < 30 m)", Bulletin of Seismological Society of America, 94(2), pp. 591-597.
3. Brandenberg, S.J., Bellana, N. and Shantz, T., 2010. "Shear Wave Velocity as a Statistical Function of Standard Penetration Test Resistance and Vertical Effective Stress at Caltrans Bridge Sites," PEER Report 201.03.
4. FHWA, 2002. Subsurface Investigations Reference Manual, Geotechnical Site Characterization.
5. Idriss, I.M. and Boulanger, R.W., 2008, "Soil Liquefaction During Earthquakes", EERI Monograph MNO-12.

INPUT SOIL PROFILE DATA							
Depth to Top of Soil Layer (feet)	Depth to Bottom of Soil Layer (feet)	Material Type USCS Group Symbol (ASTM D2487)	Total Soil Unit Weight γ_t (pcf)	Type of Soil Sampler	Field Blow Count N_{field} (blows/ft)	Pocket Penetrometer Shear Test Results PP (tsf)	Torvane Shear Test Results TV (tsf)
0.00	5.00	GC	124.5	MCal	11.0		
5.00	10.00	GC	124.5	SPT1	10.0		
10.00	15.00	GP	113.5	MCal	50.0		
15.00	20.00	GP	113.5	MCal	50.0		
20.00	25.00	SC	130.5	SPT1	21.0		
25.00	30.00	SC	130.5	MCal	16.0		
30.00	35.00	GC	133.0	SPT1	70.0		
35.00	40.00	GC	133.0	MCal	57.0		
40.00	45.00	SC	130.0	SPT1	5.0		
45.00	50.00	GP	135.0	MCal	80.0		

ESTIMATED GEOTECHNICAL DESIGN PARAMETERS																	
Bottom of Soil Layer Elevation (feet)	Soil Depth During Test (feet)	SPT Corr. For Vert. Stress C_N	SPT Corr. For Hammer Energy C_E	SPT Corr. For Borehole Size C_B	SPT Corr. For Rod Length C_R	SPT Corr. For Sampling Method C_S	Corrected SPT Blow Count N_{60}	Normalized SPT Blow Count $(N_1)_{60}$	Relative Density (%) D_r	Shear Wave Velocity (ft/s) V_s	Effective Peak Friction Angle (deg) ϕ'	Undrained Shear Strength (ksf) S_u	Apparent Density / Soil Consistency Description FHWA (2002) and AASHTO (1988)	Poisson's Ratio μ	Modulus of Elasticity (ksf) E_s	Shear Modulus (ksf) G	Bulk Modulus (ksf) K
289.00	2.50	1.700	1.333	1.150	0.750	0.650	8.2	14.0	56.00	433.84	33.00		Loose Gravel	0.25	1,243.67	829.11	497.47
284.00	7.50	1.464	1.333	1.150	0.800	1.000	12.3	18.0	64.00	584.26	34.00		Medium Dense Gravel	0.30	1,310.40	1,092.00	504.00
279.00	12.50	1.144	1.333	1.150	0.850	0.650	42.4	48.4	100.00	739.27	42.00		Dense Gravel	0.35	1,806.91	2,008.00	669.00
274.00	17.50	0.977	1.333	1.150	0.950	0.650	47.3	46.2	100.00	805.00	41.00		Dense Gravel	0.35	1,889.14	2,099.00	700.00
269.00	22.50	0.860	1.333	1.150	0.950	1.000	30.6	26.3	77.00	819.91	35.00		Dense Sand	0.35	585.88	651.00	217.00
264.00	27.50	0.772	1.333	1.150	0.950	0.650	15.1	11.7	51.00	806.51	31.00		Medium Dense Sand	0.30	405.29	338.00	156.00
259.00	32.50	0.706	1.333	1.150	1.000	1.000	107.3	75.7	100.00	1,015.30	43.00		Very Dense Gravel	0.40	2,879.00	4,798.00	1,028.00
254.00	37.50	0.654	1.333	1.150	1.000	0.650	56.8	37.1	91.00	990.30	38.00		Very Dense Gravel	0.40	2,045.37	3,409.00	730.00
249.00	42.50	0.612	1.333	1.150	1.000	1.000	7.7	4.7	32.00	842.82	29.00		Loose Sand	0.25	295.71	197.00	118.00
244.00	47.50	0.577	1.333	1.150	1.000	0.650	79.7	46.0	100.00	1,084.81	41.00		Very Dense Gravel	0.40	2,423.60	4,039.00	866.00

Mapped Seismic Parameters



Search Information

Coordinates: 33.79802, -117.814809
Elevation: 301 ft
Timestamp: 2021-03-23T18:05:11.283Z
Hazard Type: Seismic
Reference Document: ASCE7-16
Risk Category: III
Site Class: D

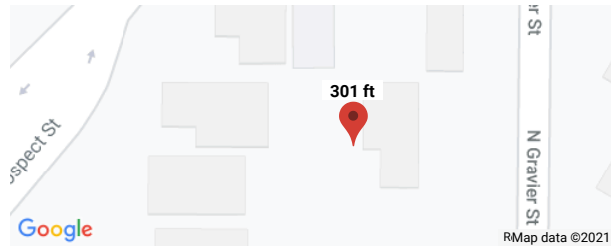

Basic Parameters

Name	Value	Description
S _S	1.401	MCE _R ground motion (period=0.2s)
S ₁	0.499	MCE _R ground motion (period=1.0s)
S _{MS}	1.401	Site-modified spectral acceleration value
S _{M1}	* null	Site-modified spectral acceleration value
S _{DS}	0.934	Numeric seismic design value at 0.2s SA
S _{D1}	* null	Numeric seismic design value at 1.0s SA

* See Section 11.4.8

Additional Information

Name	Value	Description
SDC	* null	Seismic design category
F _a	1	Site amplification factor at 0.2s
F _v	* null	Site amplification factor at 1.0s
CR _S	0.93	Coefficient of risk (0.2s)
CR ₁	0.926	Coefficient of risk (1.0s)
PGA	0.583	MCE _G peak ground acceleration
F _{PGA}	1.1	Site amplification factor at PGA
PGA _M	0.641	Site modified peak ground acceleration
T _L	8	Long-period transition period (s)
SsRT	1.401	Probabilistic risk-targeted ground motion (0.2s)
SsUH	1.507	Factored uniform-hazard spectral acceleration (2% probability of exceedance in 50 years)
SsD	1.665	Factored deterministic acceleration value (0.2s)
S1RT	0.499	Probabilistic risk-targeted ground motion (1.0s)
S1UH	0.539	Factored uniform-hazard spectral acceleration (2% probability of exceedance in 50 years)
S1D	0.6	Factored deterministic acceleration value (1.0s)
PGAd	0.677	Factored deterministic acceleration value (PGA)

* See Section 11.4.8

The results indicated here DO NOT reflect any state or local amendments to the values or any delineation lines made during the building code adoption process. Users should confirm any output obtained from this tool with the local Authority Having Jurisdiction before proceeding with design.

Disclaimer

Hazard loads are provided by the U.S. Geological Survey [Seismic Design Web Services](#).

While the information presented on this website is believed to be correct, ATC and its sponsors and contributors assume no responsibility or liability for its accuracy. The material presented in the report should not be used or relied upon for any specific application without competent examination and verification of its accuracy, suitability and applicability by engineers or other licensed professionals. ATC does not intend that the use of this information replace the sound judgment of such competent professionals, having experience and knowledge in the field of practice, nor to substitute for the standard of care required of such professionals in interpreting and applying the results of the report provided by this website. Users of the information from this website assume all liability arising from such use. Use of the output of this website does not imply approval by the governing building code bodies responsible for building code approval and interpretation for the building site described by latitude/longitude location in the report.

Seismic Hazard Deaggregation



Unified Hazard Tool

Please do not use this tool to obtain ground motion parameter values for the design code reference documents covered by the [U.S. Seismic Design Maps web tools](#) (e.g., the International Building Code and the ASCE 7 or 41 Standard). The values returned by the two applications are not identical.

^ Input

Edition

Dynamic: Conterminous U.S. 2014 (update) (v4.2.0) ▼

Spectral Period

Peak Ground Acceleration ▼

Latitude

Decimal degrees

33.79802

Time Horizon

Return period in years

2475

Longitude

Decimal degrees, negative values for western longitudes

-117.814809

Site Class

259 m/s (Site class D) ▼

^ Deaggregation

Component

Total

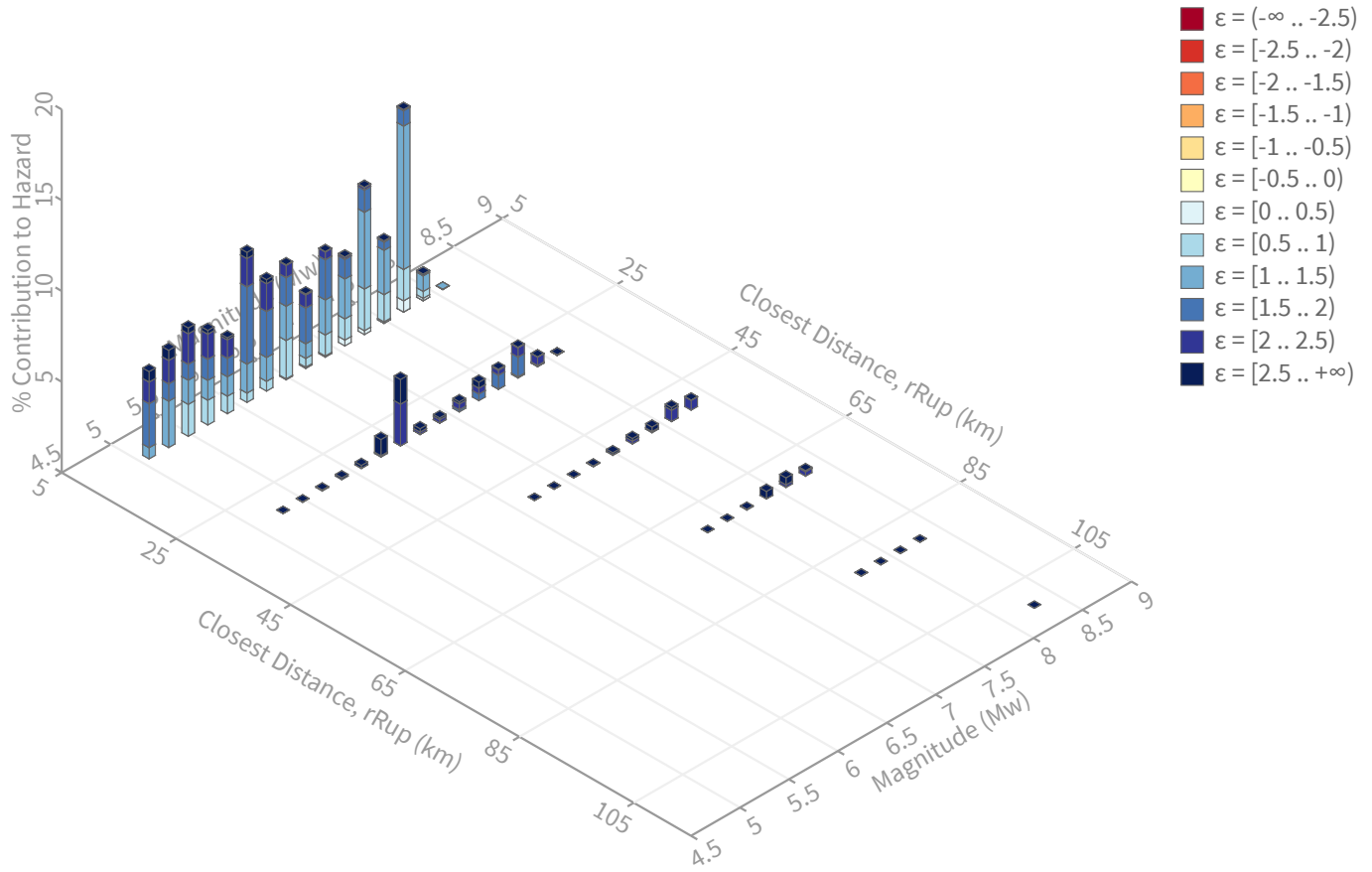

Summary statistics for, Deaggregation: Total

Deaggregation targets

Return period: 2475 yrs
Exceedance rate: 0.0004040404 yr⁻¹
PGA ground motion: 0.68455464 g

Totals

Binned: 100 %
Residual: 0 %
Trace: 0.05 %

Mode (largest m-r bin)

m: 7.72
r: 11.69 km
ε: 1.13 σ
Contribution: 11.14 %

Discretization

r: min = 0.0, max = 1000.0, Δ = 20.0 km
m: min = 4.4, max = 9.4, Δ = 0.2
ε: min = -3.0, max = 3.0, Δ = 0.5 σ

Recovered targets

Return period: 2973.518 yrs
Exceedance rate: 0.00033630198 yr⁻¹

Mean (over all sources)

m: 6.62
r: 13.64 km
ε: 1.57 σ

Mode (largest m-r-ε bin)

m: 7.72
r: 12.64 km
ε: 1.2 σ
Contribution: 7.9 %

Epsilon keys

ε0: [-∞ .. -2.5)
ε1: [-2.5 .. -2.0)
ε2: [-2.0 .. -1.5)
ε3: [-1.5 .. -1.0)
ε4: [-1.0 .. -0.5)
ε5: [-0.5 .. 0.0)
ε6: [0.0 .. 0.5)
ε7: [0.5 .. 1.0)
ε8: [1.0 .. 1.5)
ε9: [1.5 .. 2.0)
ε10: [2.0 .. 2.5)
ε11: [2.5 .. +∞]

Deaggregation Contributors

Source Set	Source	Type	r	m	ϵ_0	lon	lat	az	%
UC33brAvg_FM31		System							31.21
	Whittier alt 1 [2]		12.20	7.44	1.36	117.749°W	33.893°N	29.95	6.25
	Peralta Hills [0]		4.47	6.87	0.90	117.814°W	33.835°N	1.19	4.65
	Chino alt 1 [3]		15.06	6.72	1.81	117.662°W	33.910°N	48.45	2.85
	Compton [0]		17.25	7.23	1.18	118.043°W	33.702°N	243.35	2.46
	Elsinore (Glen Ivy) rev [0]		21.09	6.58	2.40	117.590°W	33.829°N	80.55	2.39
	San Joaquin Hills [1]		14.89	7.55	1.37	117.835°W	33.668°N	187.53	1.74
	Anaheim [0]		12.92	6.92	1.30	117.943°W	33.780°N	260.50	1.09
UC33brAvg_FM32		System							30.13
	Whittier alt 2 [2]		12.14	7.57	1.29	117.755°W	33.895°N	27.09	5.54
	Peralta Hills [0]		4.47	7.28	0.73	117.814°W	33.835°N	1.19	3.52
	Richfield [0]		10.51	6.34	1.72	117.828°W	33.886°N	352.87	2.62
	Compton [0]		17.25	7.28	1.17	118.043°W	33.702°N	243.35	2.62
	Elsinore (Glen Ivy) rev [0]		21.09	6.57	2.41	117.590°W	33.829°N	80.55	2.41
	Chino alt 2 [2]		17.72	6.98	1.79	117.652°W	33.902°N	52.51	2.11
	San Joaquin Hills [1]		14.89	7.25	1.56	117.835°W	33.668°N	187.53	1.85
	Anaheim [0]		12.92	6.98	1.25	117.943°W	33.780°N	260.50	1.12
	Yorba Linda [0]		9.19	7.54	0.81	117.860°W	33.871°N	332.45	1.04
UC33brAvg_FM32 (opt)		Grid							19.48
	PointSourceFinite: -117.815, 33.812		5.25	5.60	1.19	117.815°W	33.812°N	0.00	4.21
	PointSourceFinite: -117.815, 33.812		5.25	5.60	1.19	117.815°W	33.812°N	0.00	4.21
	PointSourceFinite: -117.815, 33.892		10.40	5.97	1.79	117.815°W	33.892°N	0.00	1.64
	PointSourceFinite: -117.815, 33.892		10.40	5.97	1.79	117.815°W	33.892°N	0.00	1.64
	PointSourceFinite: -117.815, 33.865		8.41	5.86	1.59	117.815°W	33.865°N	0.00	1.53
	PointSourceFinite: -117.815, 33.865		8.41	5.86	1.59	117.815°W	33.865°N	0.00	1.53
UC33brAvg_FM31 (opt)		Grid							19.18
	PointSourceFinite: -117.815, 33.812		5.25	5.60	1.19	117.815°W	33.812°N	0.00	4.08
	PointSourceFinite: -117.815, 33.812		5.25	5.60	1.19	117.815°W	33.812°N	0.00	4.08
	PointSourceFinite: -117.815, 33.892		10.37	5.98	1.78	117.815°W	33.892°N	0.00	1.69
	PointSourceFinite: -117.815, 33.892		10.37	5.98	1.78	117.815°W	33.892°N	0.00	1.69
	PointSourceFinite: -117.815, 33.865		8.40	5.86	1.58	117.815°W	33.865°N	0.00	1.58
	PointSourceFinite: -117.815, 33.865		8.40	5.86	1.58	117.815°W	33.865°N	0.00	1.58

Site-Specific Spectral Accelerations



Site-Specific MCE_R & Design Response Spectral Accelerations

OCWD PFAS Treatment Facility

Input Parameters

Coordinates 33.798, -117.815

Site Class D - Stiff Soil

Values used in Computation

V_{S30} 274 m/s

Z1.0 350 m

Z2.5 2050 m

Calculated Results

Site-Specific Design Parameters

S_{DS} 1.222 S_{MS} 1.832

S_{D1} 0.770 S_{M1} 1.155

MCE_G Peak Ground Acceleration (Sect. 21.5)

PGA_M 0.675 g



MCE_R Response Spectra

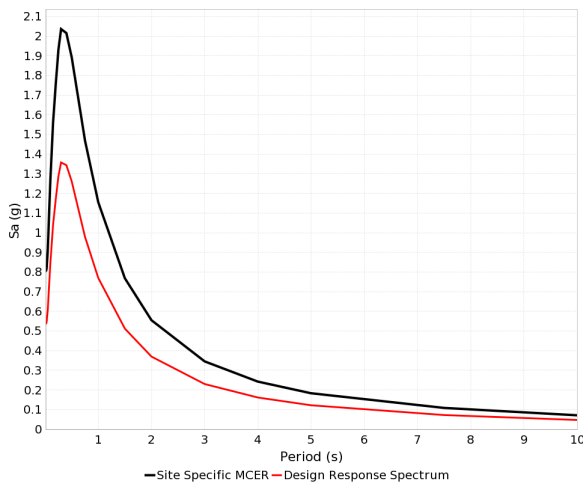

MCE_R Response Spectra Comparison

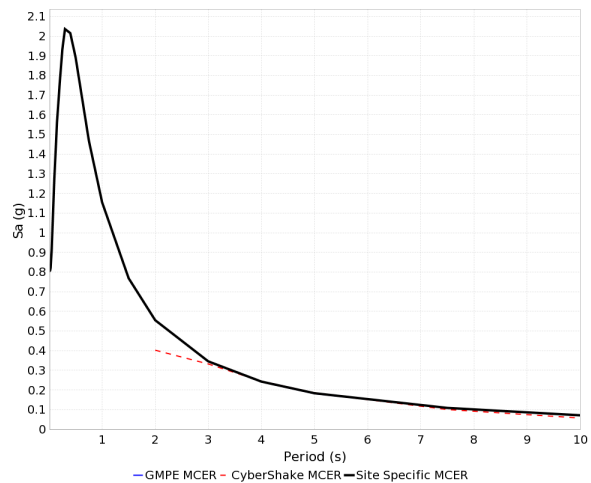

Site-Specific MCE_R & Design Response Spectral Accelerations

MCE_R Response Spectrum Table

Period (s)	GMPE Sa (g)	CyberShake Sa (g)	Site-Specific MCE_R Sa* (g)
0.01	0.805		0.805
0.02	0.808		0.808
0.03	0.821		0.821
0.05	0.912		0.912
0.075	1.097		1.097
0.1	1.276		1.276
0.15	1.562		1.562
0.2	1.756		1.756
0.25	1.930		1.930
0.3	2.036		2.036
0.4	2.016		2.016
0.5	1.893		1.893
0.75	1.469		1.469
1.0	1.155		1.155
1.5	0.768		0.768
2.0	0.555	0.403	0.555
3.0	0.346	0.332	0.346
4.0	0.242	0.244	0.243
5.0	0.182	0.185	0.184
7.5	0.109	0.101	0.109
10.0	0.071	0.058	0.071

* Site-Specific MCE_R response spectrum obtained using obtained weighted geometric averaging procedure. See User Guide: https://data2.scec.org/ugms-mcerGM-tool_v18.4/guide

Site-Specific MCE_R & Design Response Spectral Accelerations

Important Note

The site-specific, design response spectral acceleration, S_a , returned by this tool for user-specified inputs, must be compared to the minimum S_a requirement described in Section 21.3 of ASCE 7-16 (second and third paragraphs). This minimum S_a is computed as 80% of the design response spectrum derived from the SDS, SD1, and TL values obtained from the ASCE tool at <https://asce7hazardtool.online/>. The larger of the site-specific S_a and the 80% minimum S_a at each period, T , is the final design response spectral acceleration. This final $S_a \times 1.5$ is the final MCE_R response spectral acceleration.

About UGMS

The UGMS MCE_R tool was developed by the SCEC Committee for Utilization of Ground Motion Simulations (or "UGMS Committee") from research supported by the Southern California Earthquake Center (SCEC). SCEC is funded by NSF Cooperative Agreement EAR-1033462 & USGS Cooperative Agreement G12AC20038. For more information on the UGMS Committee, visit <https://www.scec.org/research/ugms>.

GEOTECHNICAL INVESTIGATION

Appendix D

Liquefaction and Seismic Settlement Analysis Results



SIMPLIFIED LIQUEFACTION HAZARDS ASSESSMENT USING STANDARD PENETRATION TEST (SPT) DATA

(Copyright © 2015, 2020, SPTLIQ, All Rights Reserved; By: InfraGEO Software)

PROJECT INFORMATION	
Project Name	OCWD PFAS Treatment Facility
Project No.	20-32-172-01
Project Location	City of Orange, California
Analyzed By	B. Abbasi
Reviewed By	C. Amante

TOPOGRAPHIC CONDITIONS	
Ground Slope, S	N/A
Free Face (L/H) Ratio	5.00 H = 20.00 feet

GROUNDWATER DATA	
GWL Depth Measured During Test	50.00 feet
GWL Depth Used in Design	30.00 feet

BORING DATA	
Boring No.	BH-3
Ground Surface Elevation	297.00 feet
Proposed Grade Elevation	297.00 feet
Borehole Diameter	8.00 inches
Hammer Weight	140.00 pounds
Hammer Drop	30.00 inches
Hammer Energy Efficiency Ratio, ER	80.00 %
Hammer Distance to Ground Surface	5.00 feet

SEISMIC DESIGN PARAMETERS	
Earthquake Moment Magnitude, M_w	7.72
Peak Ground Acceleration, A_{max}	0.68 g
Factor of Safety Against Liquefaction, FS	1.30

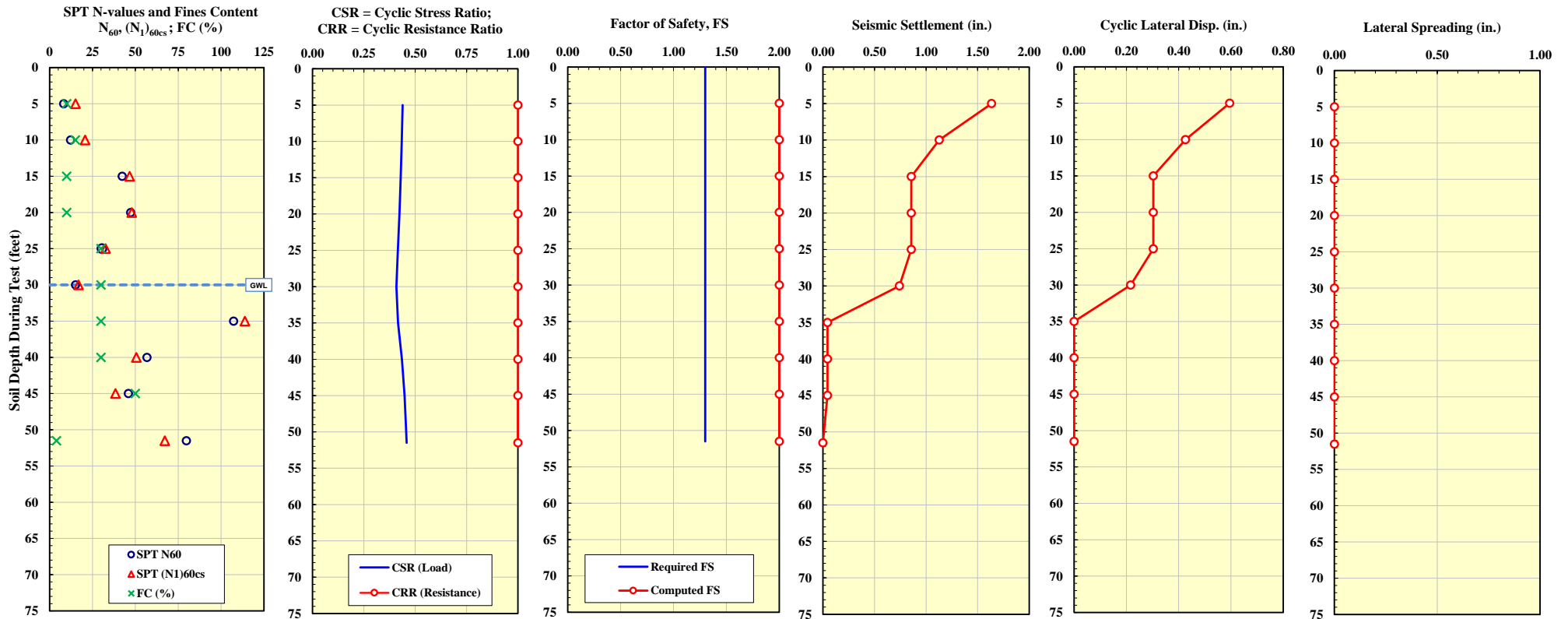

Analysis Methods Used ==>>

Liquefaction Triggering:

Boulanger-Idriss (2014)

Seismic Settlements:

Above GWL: Pradel (1998)
Below GWL: Tokimatsu and Seed (1987)

Cyclic Lateral Displacements:

Above GWL: Pradel (1998)
Below GWL: Tokimatsu and Asaka (1998)

Lateral Spreading:

Idriss and Boulanger (2008)

APPENDIX D
NOISE CALCULATIONS

Construction Generated Noise

Sensitive Receptor to Project Site	Proximate Distnace (ft.)	Anticipated Maximum Noise Level, dBA	Average Distnace (ft.)	Anticipated Average Noise Level, dBA
North Residence				
Demolition	124	76	160	74
Grading		70		68
Building Construction		70		68
Paving and Site Cleanup		76		74
West Residences				
Demolition	7	101	60	82
Grading		95		76
Building Construction		95		76
Paving and Site Cleanup		101		82
South Residence				
Demolition	15	94	50	84
Grading		88		78
Building Construction		88		78
Paving and Site Cleanup		94		84
East Residences				
Demolition	60	82	110	77
Grading		76		71
Building Construction		76		71
Paving and Site Cleanup		82		77

Source: United States Environmental Protection Agency, Noise From Construction Equipment and Operations, Building Equipment, and Home Appliances (1971)

**Construction Generated Vibration
Vibration Analysis**

North		Closest Distance (feet):		125
	Approximate RMS a Velocity at 25 ft, inch/second		Approximate RMS Velocity Level, inch/second	
Equipment				
Vibratory Roller	0.210		0.019	
Large bulldozer	0.089		0.008	
Small bulldozer	0.003		0.000	
Jackhammer	0.035		0.003	
Loaded trucks	0.076		0.007	
	Criteria		0.300	
West		Closest Distance (feet):		30
	Approximate RMS a Velocity at 25 ft, inch/second		Approximate RMS Velocity Level, inch/second	
Equipment				
Vibratory Roller	0.210		0.160	
Large bulldozer	0.089		0.068	
Small bulldozer	0.003		0.002	
Jackhammer	0.035		0.027	
Loaded trucks	0.076		0.058	
	Criteria		0.300	
South		Closest Distance (feet):		20
	Approximate RMS a Velocity at 25 ft, inch/second		Approximate RMS Velocity Level, inch/second	
Equipment				
Vibratory Roller	0.210		0.293	
Large bulldozer	0.089		0.124	
Small bulldozer	0.003		0.004	
Jackhammer	0.035		0.049	
Loaded trucks	0.076		0.106	
	Criteria		0.300	
East		Closest Distance (feet):		80
	Approximate RMS a Velocity at 25 ft, inch/second		Approximate RMS Velocity Level, inch/second	
Equipment				
Vibratory Roller	0.210		0.037	
Large bulldozer	0.089		0.016	
Small bulldozer	0.003		0.001	
Jackhammer	0.035		0.006	
Loaded trucks	0.076		0.013	
	Criteria		0.300	

Based on distance to nearest structure
Source: Based on methodology from the United States Department of Transportation Federal Transit Administration, *Transit Noise and Vibration Impact*

APPENDIX E
BASIS OF DESIGN REPORT – FINAL

OCWD Project No. IRWD-2021-1
IRWD Project PR 11720
IRWD OPA-1 PFAS Water Treatment Project
Basis of Design Report - Final

Orange County Water District and
Irvine Ranch Water District

May 25, 2021

Prepared for:

Orange County Water District
18700 Ward Street
Fountain Valley, CA 92708

and

Irvine Ranch Water District
15600 Sand Canyon Ave,
Irvine, CA 92618

Prepared by:

AECOM
999 Town and Country Road
Orange, CA 92868
aecom.com

Copyright © 2021 by AECOM

All rights reserved. No part of this copyrighted work may be reproduced, distributed, or transmitted in any form or by any means without the prior written permission of AECOM.

Table of Contents

Abbreviations and Acronyms	vi
Executive Summary	viii
1. Introduction	1
1.1 Background Information	1
1.2 Project Summary	2
1.3 Purpose of this Basis of Design (BOD) Report	2
2. Review of Existing Information for Water Quality and Existing Facilities	3
2.1 Data Gathering and Review	3
2.2 PFAS Levels at the OPA-1 Well	3
2.3 Water Quality at OPA-1	4
2.4 Water Quality Goals.....	6
3. Site Master Plan and Basis of Design Criteria.....	7
3.1 Design Criteria Decisions During the Preliminary Design Phase	7
3.2 Site Master Plan	7
3.2.1 Site Master Plan Alternative 1.....	7
3.2.2 Site Master Plan Alternative 2 - AECOM's Recommended Alternative	9
3.3 Backflow Preventer Location	10
3.3.1 Backflow Preventer Location Option 1.....	10
3.3.2 Backflow Preventer Location Option 2 – AECOM's Recommended Alternative	10
3.4 Base Design Criteria.....	11
4. Civil Site Design	13
4.1 Civil Design Description.....	13
4.1.1 Site Access	13
4.1.2 New Access Driveway	14
4.1.3 Pipelines and Utilities Routing	14
4.2 Civil Design Criteria	16
5. Mechanical Design.....	17
5.1 Treatment System Description	17
5.2 Mechanical Design Description	17
5.2.1 Groundwater Extraction Pump Upgrade	18
5.2.2 Bag Filtration System	18
5.2.3 IX Vessels	20
5.2.4 Sump Pump System	21
5.2.5 Piping and Appurtenances.....	22
5.2.6 HVAC Evaluation	24
5.3 Hydraulic Evaluation.....	24
5.3.1 Treatment System.....	24

5.3.2	Landscaping Water Supply	25
5.4	Mechanical Design Codes and Standards	25
5.5	Structural Design	26
5.6	Structural Design Requirements.....	26
5.7	Structural Design Codes and Standards	28
6.	Architectural and Landscaping Design	29
6.1	Architectural Design Requirements	29
6.2	Architectural Codes and Standards	29
7.	Noise Requirements.....	30
8.	Electrical Design	32
8.1	Electrical Room Upgrades	32
8.2	Instrumentation	32
8.3	Tank Area Lighting.....	32
8.4	Site Electric Gate	33
9.	Utilities.....	34
10.	Permitting	35
11.	Estimate of Probable Costs	36
12.	Project Schedule	37
13.	30% Drawings	38

Appendices

- Appendix A: Site Survey
- Appendix B: Utility Research
- Appendix C: Geotechnical Investigation
- Appendix D: Well Pump Cut Sheet
- Appendix E: Bag Filter Cut Sheet
- Appendix F: IX Vessels Cut Sheet
- Appendix G: Sump Pump Cut Sheet
- Appendix H: Calculations Binder
- Appendix I: Cost Evaluation

Figures

Figure 1-1:	OPA-1 Existing Facilities and Area Designated for PFAS Treatment.....	1
Figure 3-1:	Site Master Plan - Alternative 1	8
Figure 3-2:	IX Vessels, Bag Filters, and Antisiphon Loop Section – Alternative 1	8
Figure 3-3:	Site Master Plan - Alternative 2	9
Figure 3-4:	IX Vessels, Bag Filters, and Antisiphon Loop Section - Alternative 2.....	9
Figure 3-5:	Backflow Preventer - Option 1	10
Figure 3-6:	Backflow Preventer - Option 2.....	11
Figure 3-7:	Acoustic Insulation for Valves - VYC Industrial	11
Figure 4-1:	Evoqua Truck for IX Replacement Service on N. Gravier Rd.	13
Figure 4-2:	City of Orange Department of Public Works Standard Plan 115 Commercial Driveway Apron	14
Figure 4-3:	Pipelines Routes for Site Master Plan Alternative 1.....	15
Figure 4-4:	Pipelines Routes for Site Master Plan Alternative 2.....	15
Figure 4-5:	Route for Chemical Feeds To Injection Points Relocated Outside of Pump Station	16
Figure 5-1:	Bag Filter Pressure Vessel - Fil-Trek Corporation LP Series.....	19
Figure 5-2:	IX Vessels Skid - Evoqua Model HP1220CIX	20
Figure 5-3:	Duplex Sump Pump System with Typical Installation – (left IRWD installation detail 2021, Construction Manual, STD. DWG. G-6, right Zoeller duplex sump pump assembly)	21
Figure 5-4:	Available Connection to Existing Irrigation Header for Landscaping Water Supply.....	25
Figure 7-1:	Typical Noise Values for Nidiec Vertical Motors - 2020 Product Specifications.....	31

Tables

Table 2-1:	Results of PFAS Sampling at the OPA-1 Well - as reported in the July 2020 Producer Report (average concentration)	4
Table 2-2:	Results of Water Quality Sampling for Inorganic Constituents at OPA-1 Well (2000 – 2019) – as reported in the July 2020 Producer Report	5
Table 2-3:	Recommended Pretreatment Water Quality Requirements - July 2020 Producer Report	6
Table 3-1:	OPA-1 PFAS Project Base Design Criteria	12
Table 4-1:	OPA-1 Project Civil Design Criteria	16
Table 5-1:	OPA-1 Groundwater Pump: Existing versus Upgraded Pump	18
Table 5-2:	Prefiltration System for OPA-1	19
Table 5-3:	IX Vessels Design Criteria	20
Table 5-4:	IX Vessels Pit Sump Pump	22
Table 5-5:	Piping Schedule	22
Table 5-6:	Yard Piping	23
Table 5-7:	Valves	23
Table 5-8:	Hydraulic Calculation Assumptions	24
Table 5-9:	Hydraulic Analysis Summary	24
Table 5-10:	OPA-1 PFAS Project Structural Design Criteria	26
Table 6-1:	OPA-1 PFAS Project Architectural Design Criteria	29
Table 11-1:	OPA-1 PFAS 30% Design Level Estimate - Class 3 - Options Summary	36

Abbreviations and Acronyms

µg/L	micrograms per liter
5 EtFOSA	5-ethyl perfluorooctane sulfonamide
AECOM	AECOM Technical Services, Inc.
BOD	Bases of Design
CaCO ₃	calcium carbonate
CCR	California Code of Regulations
CMU	concrete masonry unity
CT	current transformer
dBA	A-weighted decibels
DDW	Division of Drinking Water
EBCT	Empty Bed Contact Time
gpm	gallons per minute
hp	horsepower
IRWD	Irvine Water Ranch District
IX	ion exchange
L	liters
MCL(s)	maximum contaminant level(s)
MeFOSA	N-methyl perfluorooctane sulfonamide
Mfr.	manufacturer
mg/L	milligrams per liter
ND	non-detect
ng/L	nanograms per liter
NOM	natural organic matter
NTU	nephelometric turbidity unit
OCWD	Orange County Water District
OPA-1	Orange Park Acres Well No. 1
PFAS	per- and polyfluoroalkyl substances
PFD _o A	perfluorododecanoate
PFH _x A (C6)	perfluorohexanoic acid
PFH _x S (C6)	perfluorohexane sulfonic
PFOA	perfluorooctanoic acid
PFOS	perfluorooctane sulfonate
PFTA	perfluorotetradecanoic acid
PFT _r DA	perfluorotridecanoic acid
PFUnA	perfluoroundecanoate
ppt	parts per trillion

psi	pounds per square inch
RL(s)	response level(s)
RPM	revolutions per minute
SCE	Southern California Edison
SMCLs	secondary MCLs
TDS	total dissolved solids
TEFC	totally enclose fan cooled
UL	Underwriter Laboratories
US EPA	U.S. Environmental Protection Agency
VFD	variable frequency drive

Executive Summary

The purpose of the project is to provide the design of a treatment system for the removal of per- and polyfluoroalkyl substances (PFAS)—more specifically perfluorooctanoic acid (PFOA) and perfluorooctane sulfonate (PFOS)—from the groundwater extracted by the existing Orange Park Acres Well No. 1 (OPA--1). The treatment system will be designed to remove PFAS to a maximum concentration of 2 nanograms per liter (ng/L) prior to distribution of the treated water. The new treatment facilities are planned to be constructed on IRWD's property adjacent to the OPA-1 well site. Key features of the new facilities include:

- Installation of ion exchange (IX) vessels for treatment of PFAS. The vessels will be installed outdoors in a recessed concrete pit to minimize visual impacts to the surrounding homes.
- Modifications to the existing groundwater extraction pump to meet the new hydraulic conditions resulting from additional head loss generated by the IX vessels, particulate filters, and new mechanical piping and appurtenances.
- Modifications to the electrical and control system to integrate the new process and upsized pump.
- Modification to the site to provide ease of access and minimized impacts to the surrounding neighborhood.

The proposed operational concept for OPA-1 includes pumping from the upsized well pump through the IX treatment system. The IX treated water will be conveyed to the existing clear well located within the existing pump station. The existing booster pump will then draw treated water from the clear well and convey flow at the required Zone 5 pressure.

1. Introduction

1.1 Background Information

Irvine Water Ranch District (IRWD) owns and operates the Orange Park Acres Well No. 1 (OPA-1) located at 678 N. Gravier Street, Orange CA, 92869, which includes the groundwater extraction well, clear well with a booster pump, and a chloramine disinfection system. The facility is currently designed to produce up to 2,000 gallons per minute (gpm) of drinking water for delivery to the District's Santiago Hills Zone 5 system. The pump station and chemical facilities are designed to host a future additional well and booster pump for a higher production rate of up to 4,000 gpm. Figure 1-1 illustrates the existing OPA-1 facilities and the area designated for construction of the PFAS treatment facilities.



Figure 1-1: OPA-1 Existing Facilities and Area Designated for PFAS Treatment

On February 6, 2020, the State Water Board's Division of Drinking Water (DDW) issued revised drinking water response levels (RLs) of 10 parts per trillion (ppt) for perfluorooctanoic acid (PFOA) and 40 ppt for perfluorooctane sulfonate (PFOS). As PFOA and PFOS levels in the groundwater produced at OPA-1 exceeded the guidance set by DDW, IRWD took OPA-1 out of production, as recommended by the State Water Resources Control Board until a per- and polyfluoroalkyl substances (PFAS) mitigation strategy is implemented.

Orange County Water District (OCWD), which is partnering with IRWD in addressing the PFAS contamination, conducted a study to evaluate alternatives for lowering the concentration of PFOA and PFOS to nondetect (ND) levels, which is defined as 2 nanograms per liter (ng/L) or less in the July 2020 producer's report. The alternatives evaluated included shutting down the well permanently, blending drinking water sources with low PFAS concentrations, and PFAS treatment. At the end of this analysis, the alternative selected for OPA-1 was the treatment of PFAS with ion exchange (IX) vessels.

Based on the well water quality, OCWD is selecting the type of IX resins. The OCWD has also preselected and prepurchased the IX vessels to be used in this project.

1.2 Project Summary

The purpose of the project is to provide treatment for PFAS at the existing OPA-1 facilities. The Engineering Design Services for IRWD's Well OPA-1 PFAS Treatment System Project includes the design of the following major components:

- IX vessels and appurtenances for the treatment of PFAS in the groundwater
- New structures in support of the IX vessels
- Modifications of the existing groundwater extraction pump and electric motor to meet the increased head loss caused by the IX vessels, particulate filters, pipelines, and valves
- Partial reconfiguration of mechanical piping and appurtenances inside the existing pump station building
- Modifications of the electrical facilities to support a larger groundwater extraction pump and the new treatment system
- Site improvements
- Clearing and demolition of the house on the lot (owned by IRWD) adjacent to the existing pump station and chemical treatment building to make room for the PFAS treatment system
- Site configuration to provide access to allow access to the new IX vessels and preserve the access to the existing buildings
- Underground yard piping and electrical conduits
- Pipelines from the existing groundwater extraction well pump to the IX vessels and return pipeline from the IX vessels to the existing wet well
- Connections for well discharge, IX discharge, and wastewater bypass lines
- Perimeter wall and vehicle and man access gates
- Finished grading and paving
- Landscaping
- Measures to mitigate the visual and noise impact of the new facilities on the surrounding neighborhoods

1.3 Purpose of this Basis of Design (BOD) Report

This Basis of Design (BOD) Report summarizes the site master planning and conceptual design elements as discussed with OCWD and IRWD. It also provides AECOM's recommended layout for the treatment system and modifications to the existing pump station.

2. Review of Existing Information for Water Quality and Existing Facilities

2.1 Data Gathering and Review

As part of this project, AECOM Technical Services, Inc. (AECOM) has reviewed relevant project documents. The scope of the review focused on hydraulic considerations, site constraints, operational concepts, and facility considerations associated with the proposed PFAS treatment. The existing conditions were discussed in meetings with OCWD and IRWD. The documents reviewed include the following:

- Producer Report Irvine Ranch Water District (Prepared by Carollo Engineers, dated July 2020)
- Orange Park Acres Well No. 1 Wellhead Facilities Project No. 11405 (1250) As Build Record Drawings (Prepared by URS Corporation, dated August 4, 2015)
- Orange Park Acres Well No. 1 Wellhead Facilities Project No. 11405 (1250) Specifications and Submittals (Compiled by URS Corporation)
- Orange Park Acres Well No. 1 Wellhead Facilities Project No. 11405 (1250) Basis of Design Validation Memorandum (Prepared by URS Corporation, dated April 26, 2013)
- Geotechnical Investigation Report Orange Park Acres Well No. 1 Wellhead Facilities (Prepared by Converse Consultants, Dated August 2, 2012)
- Orange Park Acres Well No. 1 Wellhead Facilities, Basis of Design Report (Prepared by Kennedy/Jenks Consultants, dated June 15, 2012)

The July 2020 Producer Report includes a summary of the OPA-1 well water quality for PFAS and other contaminants as well as the OCWD and IRWD goals for PFAS treatment.

2.2 PFAS Levels at the OPA-1 Well

The results for three sampling events for PFAS conducted between August 2018 and June 2019 for the OPA-1 well are reported in Table 2-1.

The following is a summary of the PFAS sampling results for OPA-1:

- The average combined concentration of PFOA and PFOS is 38.8 ng/L.
- The average measured PFOA concentration is 15.4 ng/L, which is greater than the 5.1 ng/L notification level and 10 ng/L response level.
- The average measured PFOS concentration is 23.5 ng/L, which is greater than the 6.5 ng/L notification level but below the 40 ng/L response level.
- Concentrations of perfluorohexanoic acid (PFHxA [C6]) and perfluorohexane sulfonic (PFHxS [C6]) were observed above the detection limit.
- 5-ethyl perfluorooctane sulfonamide (5 EtFOSA), N-methyl perfluorooctane sulfonamide (MeFOSA), perfluorododecanoate (PFDoA), perfluorotetradecanoic acid (PFTA), perfluorotridecanoic acid (PFTrDA), and perfluoroundecanoate (PFUnA) were all below the detection limit.

Table 2-1: Results of PFAS Sampling at the OPA-1 Well - as reported in the July 2020 Producer Report (average concentration)

PFAS Species	Well OPA-1
N-ethyl perfluorooctanesulfonamidoacetic acid (EtFOSA), ng/L	0.4 ¹
N-methyl perfluorooctanesulfonamidoacetic acid (MeFOSA), ng/L	0.4 ¹
Perfluorobutane sulfonic acid (PFBS), ng/L	7.87
Perfluorodecanoic acid (PFDA), ng/L	0.4
Perfluorododecanoic acid (PFDoA), ng/L	0.4
Perfluoroheptanoic acid (PFHpA), ng/L	2.87
Perfluorohexanoic acid (PFHxA), ng/L	6.20
Perfluorohexane sulfonic acid (PFHxS), ng/L	11.8
Perfluorononanoic acid (PFNA), ng/L	0.4
Perfluorotetradecanoic acid (PFTA), ng/L	0.4
Perfluorotridecanoic acid (PFTrDA), ng/L	0.4
Perfluoroundecanoic acid (PFUnA), ng/L	0.4
Perfluorooctanoic acid (PFOA), ng/L	15.4
Perfluorooctane sulfonate (PFOS), ng/L	23.5
PFOA + PFOS, ng/L	38.8

¹ Below the Level of Quantification (LOQ). Value assigned as 0.4 ng/L (i.e., LOD/2).

2.3 Water Quality at OPA-1

Inorganic constituents measured at the OPA-1 Well U.S. Environmental Protection Agency (US EPA) maximum contaminant levels (MCLs), and the secondary MCLs (SMCLs) are reported in Table 2-2. Overall, the water quality parameters reported for OPA-1 meet current standards except for total dissolved solids (TDS) which exceeds the SMCL. The July 2020 Producer Report also suggests that the water quality has been stable between 2000 and 2019.

Table 2-2: Results of Water Quality Sampling for Inorganic Constituents at OPA-1 Well (2000 – 2019) – as reported in the July 2020 Producer Report

Water Quality Parameter	Well OPA-1	MCL or SMCL
Alkalinity, Total (as CaCO ₃), mg/LK CaCO ₃	212	-
Aluminum, µg/L	4.69	50-200 ¹
Arsenic, µg/L	0.1	10
Barium, µg/L	59.1	-
Calcium, mg/L	123	-
Chloride, mg/L	109	250 ¹
Fluoride, mg/L	0.2	2 ¹
Iron, µg/L	13.5	30 ¹ 0
Magnesium, mg/L	33.9	-
Manganese, µg/L	0.1	50 ¹
Nitrate as NO ₃ , mg/L	14.3	44
PCE, µg/L	-	5
pH, pH units	7.7	6.5-8.5 ¹
Phosphate, mg/L	0.02	-
Sulfate, mg/L	178	250 ¹
TCE, µg/L	-	5
Total Dissolved Solids, mg/L	695	500 ¹
Total Organic Carbon, mg/L	0.37	-
TTHMs, µg/L	0.45	80

¹Secondary maximum contaminant level (SMCL)

Typically, PFAS removal by IX resins is more heavily influenced by the PFAS chain-length and physicochemical properties of the resin than water quality. Nevertheless, the presence of certain inorganic and organic contaminants in the water to be treated can affect the removal of PFAS or the longevity of IX resins. For example, the concentration of natural organic matter (NOM), the concentration of other organic contaminants, ionic strength, and pH may impact the efficiency of the IX resins.

Table 2-3 lists general recommended pretreatment water quality requirements which were generated through the discussion with media vendors (from the July 2020 Producer Report). Table 2-3 suggests that the critical parameters affecting PFAS treatment with IX resins are not exceeded. However, although the turbidity is below the 1 nephelometric turbidity unit (NTU) limit for adsorption, the installation of a bag filtration system to limit the amount of particulate material that could be conveyed from the well to the IX filters is recommended.

Table 2-3: Recommended Pretreatment Water Quality Requirements - July 2020 Producer Report

Parameter	Units	Limit for Adsorption	Minimum	Average	Maximum
Iron ¹	µg/L	1,000	0.1	14	67
Manganese ¹	µg/L	1,00	0.1	0.1	0.1
pH ²	-	9	7.4	7.6	8
Turbidity ²	NTU	1	0.01	0.2	0.3
TOC ⁴	mg/L	1	0.2	0.4	0.5

¹ Iron and manganese are problematic at >1 mg/L, which is in excess of the secondary MCLs. Above 1 mg/L will require pretreatment to prevent colloidal fouling.

² Optimal pH is <9. As the pH of zero-point charge for activated carbons is between 7.2 (Calgon F400) and 6.4 (Norit GAC400). Waters with significantly higher pH exhibit lower PFAS removal from electrostatic repulsion with negatively charged polar headgroups on PFAS.

³ Turbidity higher than 1 NTU can cause colloidal fouling.

⁴ Both TOC concentration and character influence the extent to which TOC directly competes with contaminants for adsorption sites or indirectly blocks pores via steric hindrance. Higher than 1 mg/L will indicate waters that may need more frequent media replacement.

⁵ Sample data from April 2000 to May 2019.

2.4 Water Quality Goals

The treatment goal target of 2 ng/L for PFOA and PFOS was selected by OCWD and IRWD to protect public health and to meet regulatory requirements that may be established in the future (July 2020 Producer Report). In addition, the existing OPA-1 disinfection facilities are to continue to provide the delivery of drinking water with the appropriate level of residual disinfectant to minimize microbial contamination in the storage and distribution system.

3. Site Master Plan and Basis of Design Criteria

This section lists the design criteria established through discussions with OCWD and IRWD during the preliminary design phase.

3.1 Design Criteria Decisions During the Preliminary Design Phase

Several design options were discussed during the progress meeting held amongst OCWD, IRWD, and the design team. Key decisions made during this phase included:

- PFAS treatment based on two pairs of Evoqua HP1220CIX Vessels (10" process piping) each filled with 424 cubic feet of resin - providing a two-minute empty bed contact time (EBCT)
- IX vessels to be located outdoor in a recessed concrete pit (approximately 10 feet below ground) to minimize the visual impacts to the neighboring residential properties
- Evaluation of two alternative locations of the IX vessels:
 - In proximity and just south of the existing hydropneumatic surge tank (Alternative 1)
 - At the southeast end of the property (Alternative 2) – AECOM's recommended alternative
- Bag filters and anti-siphon piping located at ground level on independent slabs in proximity to the IX vessels
- Modification of the existing groundwater extraction pump and motor to meet the increased head loss due to the IX vessels
- Use of the existing "future" well pipeline to pump water from the well to the PFAS treatment system
- Construction of a new pipeline to return treated water from the IX vessels to the clear well
- Two alternatives for the modification of the existing mechanical piping and appurtenances within the pump station
 - Backwash preventer assembly inside the pump station (Option 1)
 - Backwash preventer assembly outside the pump station (Option 2) - AECOM's recommended alternative
- The following studies were completed in support of this design:
 - Site Survey (Appendix A)
 - Utility Research (Appendix B)
 - Geotechnical Investigation (Appendix C)

3.2 Site Master Plan

3.2.1 Site Master Plan Alternative 1

This option involves placing two pairs of Evoqua HP1220CIX Vessels (10" process piping) near the western facility wall, with the vessels being placed on a foundation within the 10-foot deep pit as shown in Figure 3-1. Placing the vessels at 10 feet below grade reduces the net height to slightly more than the 6-foot wall that surrounds the site (see Figure 3-2), minimizing their visual impact. A stairwell would be

required at opposite ends to allow for ingress and egress. Two bag filters for the removal of particulates prior to PFAS treatment would be placed on a separate foundation outside and just north of the pit. A backflow preventer would be placed outside of the IX pit. The existing 12--inch pipeline stub-out for a future well will be extended to the future IX system influent valve tree using a 16--inch pipe (upsized to minimize head losses). Treated water will be routed in a new 16-inch pipeline to be placed above ground on concrete pipe supports along the western site boundary to the pump room for connection to the clear well. A new driveway constructed per City of Orange standards and approximately the same width as the existing driveway would be constructed along Gravier Street on the south side of the property to be used for truck access for media changeouts and other functions. Should the pit need to be expanded for the addition of future vessels to increase treatment capacity, there is room for this to the south of the proposed vessel locations.

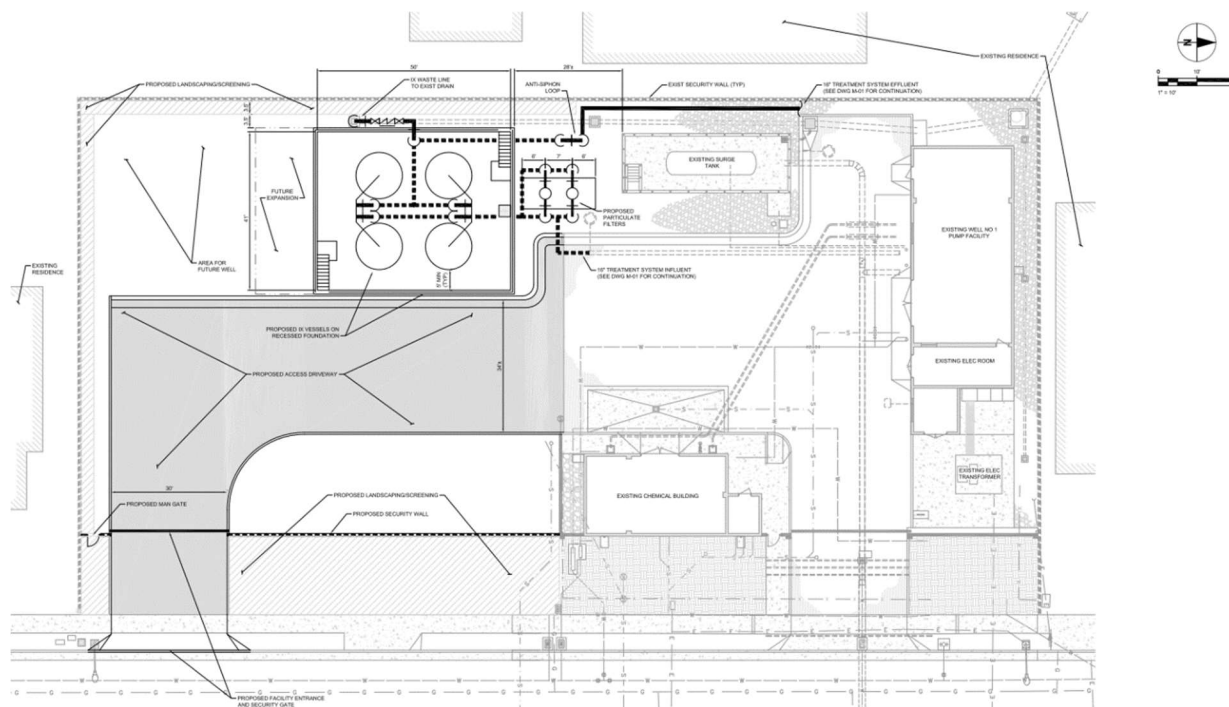

Figure 3-1: Site Master Plan - Alternative 1

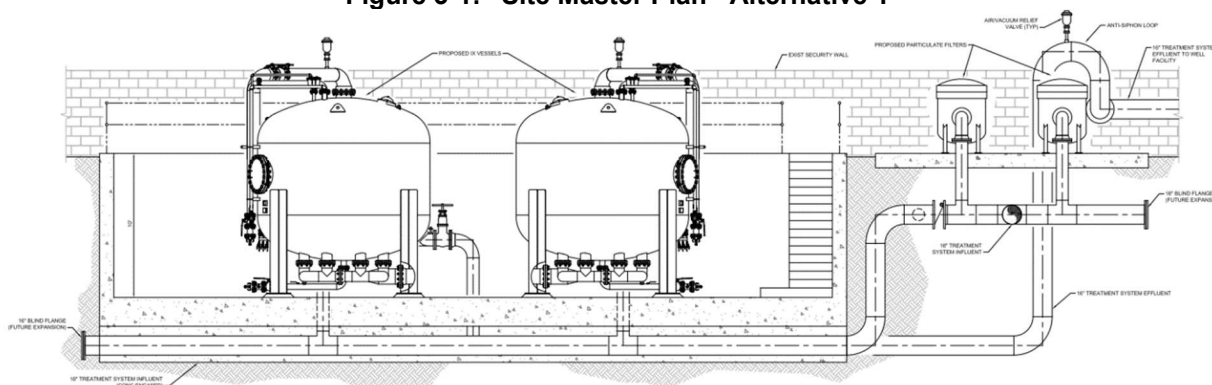

Figure 3-2: IX Vessels, Bag Filters, and Antisiphon Loop Section – Alternative 1

3.2.2 Site Master Plan Alternative 2 - AECOM's Recommended Alternative

For this option, the arrangement of the Evoqua HP1220CIX Vessels, bag filter housings, and the antisiphon loop would be similar to that for Alternative 1, except that the equipment would be placed near the southern end of the site, as shown in Figure 3-3. A new driveway of the same size as the existing driveway would also be placed along Gravier Street but would be further north than for Alternative 1 and north of the proposed vessel location. Similar to Alternative 1, influent piping would tie into the existing pipe for a future well and treated water would be routed underground to the western site wall and then would proceed above ground along the wall to the pump room. AECOM recommends this alternative.

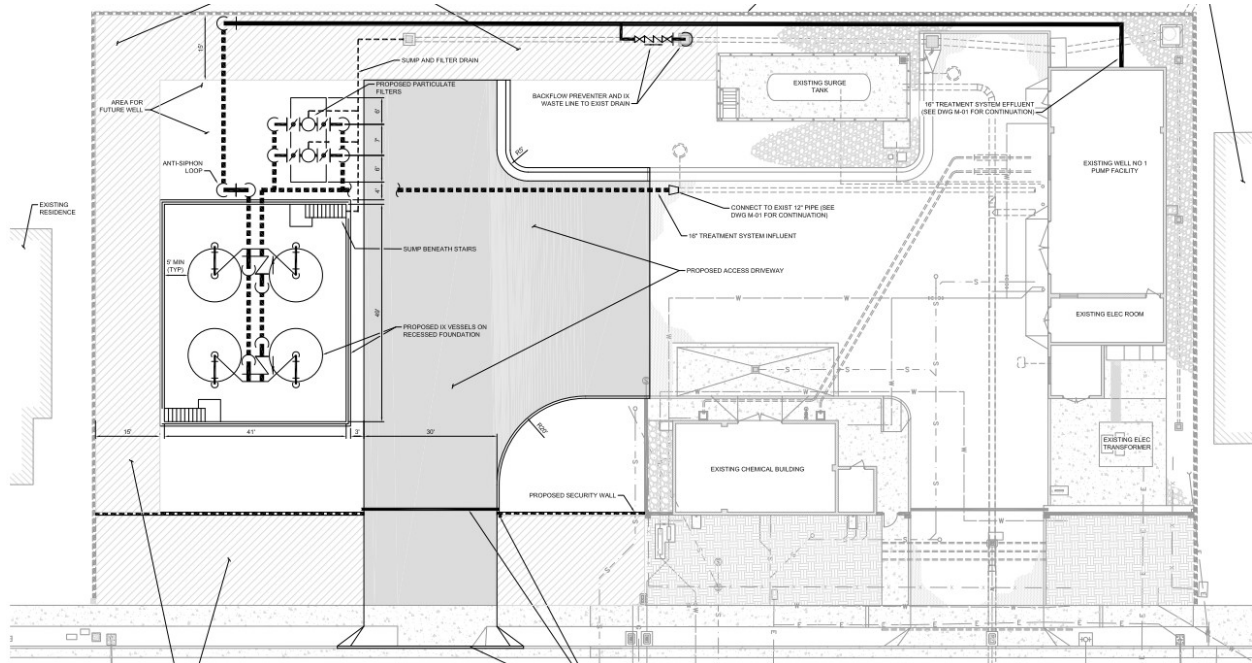

Figure 3-3: Site Master Plan - Alternative 2

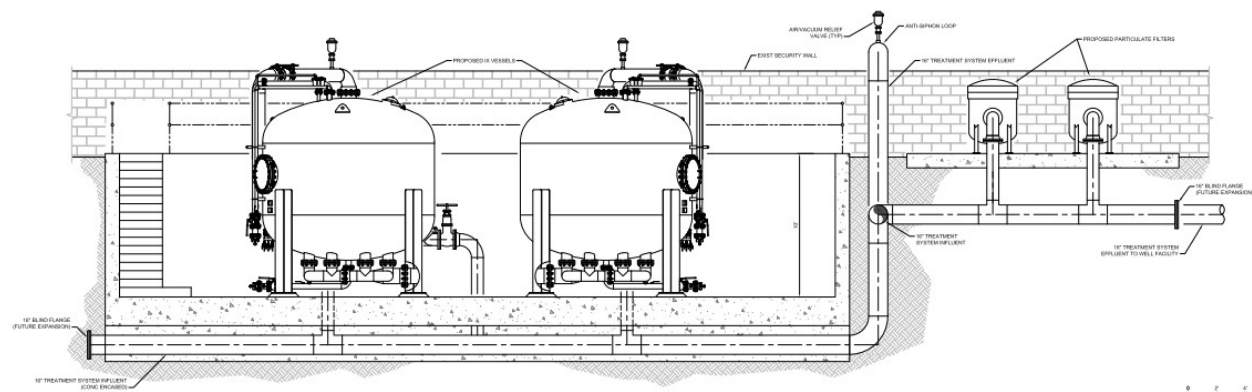

Figure 3-4: IX Vessels, Bag Filters, and Antisiphon Loop Section - Alternative 2

3.3 Backflow Preventer Location

A backflow preventer for the discharge of backwash, forward flush, and other wastewater produced from the ion exchange process during media change and if the media becomes contaminated by bacteria is necessary to prevent bacterial contamination in the treated water. The discharge of flow through the device will be infrequent. The existing extraction well backflow assembly and waste piping will be moved downstream of the IX vessels. The assembly includes two 12-inch Henry Pratt Series 821A Globe Style silent check valves. Because of their fast closure, these check valves rarely slam and hence have earned the name “silent”. However, unfortunately, all check valves allow some reverse velocity (which may increase with the age of the valve) depending on the dynamics of the system. When flow velocity is suddenly changed in a piping system, the kinetic energy of the flowing fluid turns into pressure, producing a mild slam and possibly audible noise that will carry across buildings to the neighboring houses.

3.3.1 Backflow Preventer Location Option 1

This option involves placing the backflow preventer inside the pump room, with the discharge tied into the existing pipe for the well to waste line from OPA-1, as shown in Figure 3-5. An advantage of this option is that it provides the highest degree of noise attenuation. AECOM recommends this alternative.

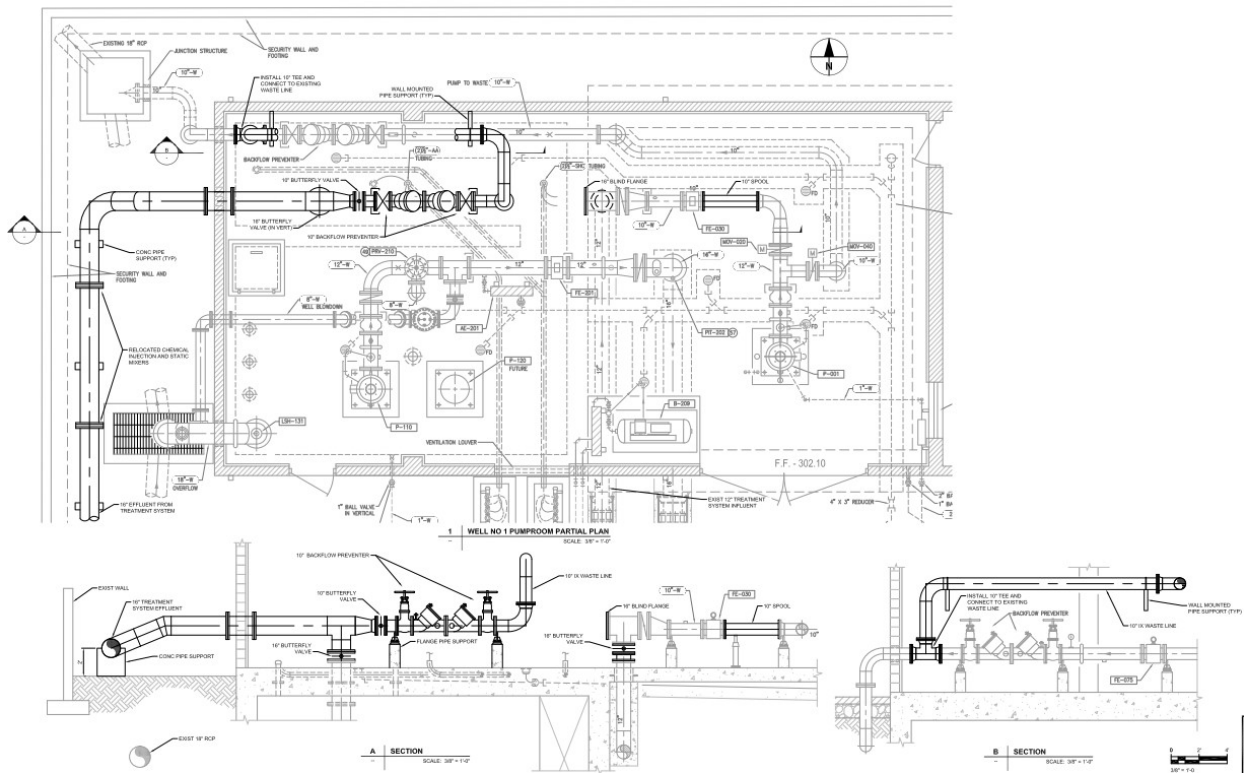

Figure 3-5: Backflow Preventer - Option 1

3.3.2 Backflow Preventer Location Option 2 – AECOM’s Recommended Alternative

With this option, the backflow preventer would be placed along the west perimeter wall as shown in Figure 3-2. Discharge from the backflow preventer would be to the existing storm drain. Although the check valves are of the “silent” type, additional sound attenuation is recommended to limit the impact on

neighboring houses. For example, a sound blanket similar to the ones shown in Figure 3-7 could be installed for sound attenuation.

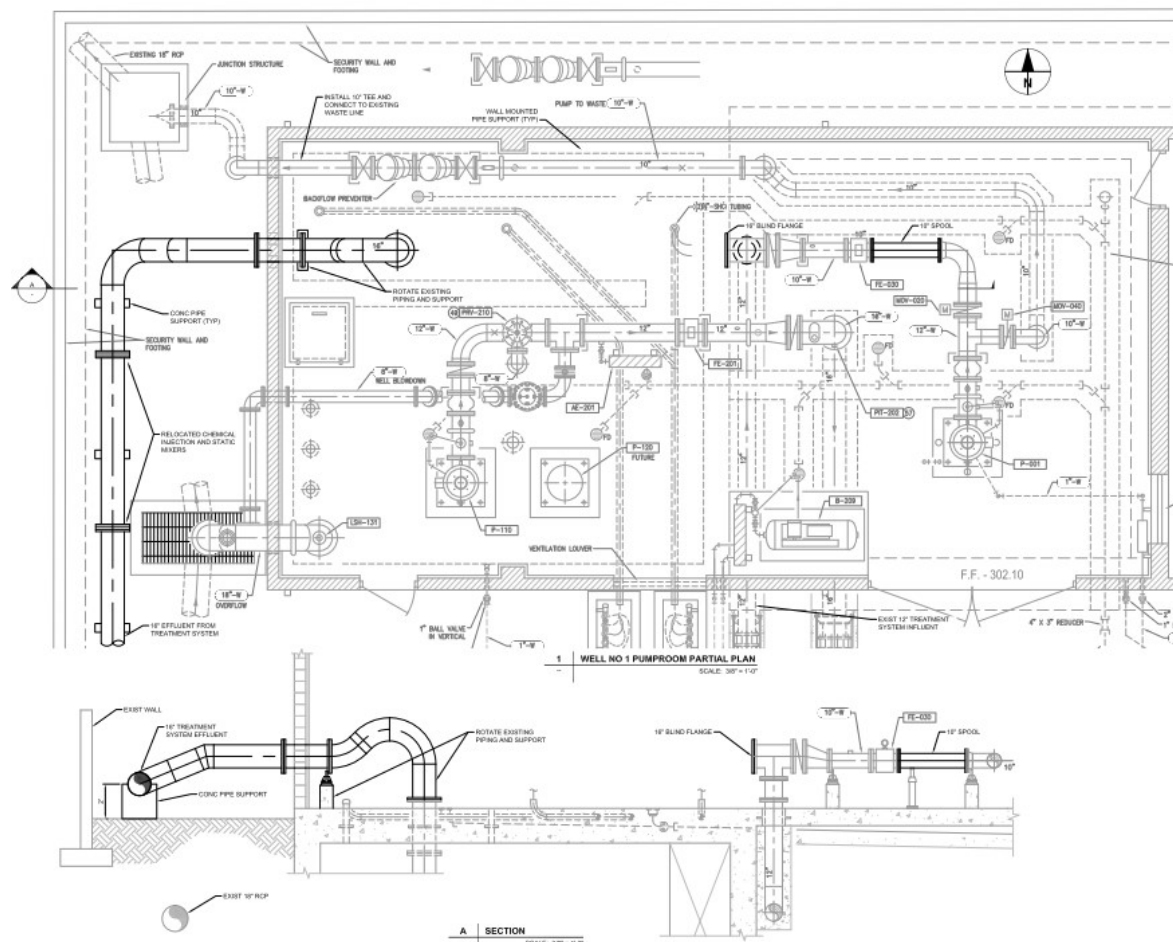

Figure 3-6: Backflow Preventer - Option 2



Figure 3-7: Acoustic Insulation for Valves - VYC Industrial

3.4 Base Design Criteria

A summary of the project design criteria for the major project components is provided in Table 3-1 following the flow of water.

Table 3-1: OPA-1 PFAS Project Base Design Criteria

Project Component	Criteria	Design Requirement
Underground pipeline from well pump to IX vessels	16-inch Pipe – Connect to “future well” pipe stub entering the pump station.	Conveyance of groundwater to treatment vessels (approximately 2,000 gpm)
IX Pretreatment	Type: Filter bag systems Number of Filters: Two Nominal filtration mesh size: 5 microns	Particulate removal upstream of IX vessels Operation: parallel with the ability to operate one filter while the second is being serviced Capacity: up to approximately 2,250 gpm per filter Headloss: approximately 15 psi max
IX Vessels	Vessel Model Evoqua HP1220CIX Number of Vessels: Four (two pairs with two vessels each) Media: Ion Exchange	PFAS removal EBCT two minutes Operation: pairs in parallel, lead / lag within each pair. Treatment Capacity Up to 1,600 gpm capacity per pair Headloss: approximately 30 psi max
IX Vessel Pit	Minimize visual impact to neighboring properties Maintenance access Safety Precipitation management	10 ft depth Minimum 5-ft space around vessels
Pipeline from IX vessels to Clearwell Piping	16” Pipe	Conveyance of treated groundwater from IX vessels to existing clearwell (approximately 2,000 gpm)
Well pump modifications	Upgrade existing pump to meet new hydraulic conditions	2,000 gpm average capacity at new pressure head
Site Access	Allow ease of access for IX resins delivery truck	Drive through road and access gate

4. Civil Site Design

4.1 Civil Design Description

The civil design for the selected site master planning alternative will include the following:

- Site plan including site access and perimeter wall
- Grading and paving plan
- Pipelines and utilities routing

4.1.1 Site Access

Several options for site access with the IX service trucks were evaluated using a computer model. The model assumed that the neighborhood is entirely residential and that cars are parked on both sides of the street in front of the IRWD's facilities. Modelling results showed a tight clearance from the parked cars on North Gravier street during truck access. On February 11, 2011, an IX service truck provided by Evoqua was driven on-site to test access to the existing driveway (see Figure 4-1). The truck was able to drive in and out the existing driveway without issue and demonstrated the ability to park near both of the proposed locations for the treatment vessels.



Figure 4-1: Evoqua Truck for IX Replacement Service on N. Gravier Rd.

4.1.2 New Access Driveway

The new access driveway will be designed to match the existing driveway and the City of Orange Department of Public Works Standard Plan 115 Commercial Driveway Apron, which include

- A width of 30 feet to match the existing driveway.
- Minimum 22 feet of full-height curb between the two driveways
- Minimum 2 feet of full-height curb between driveway and the property line

Figure 4-2 shows details of the driveway design, as required by the City.

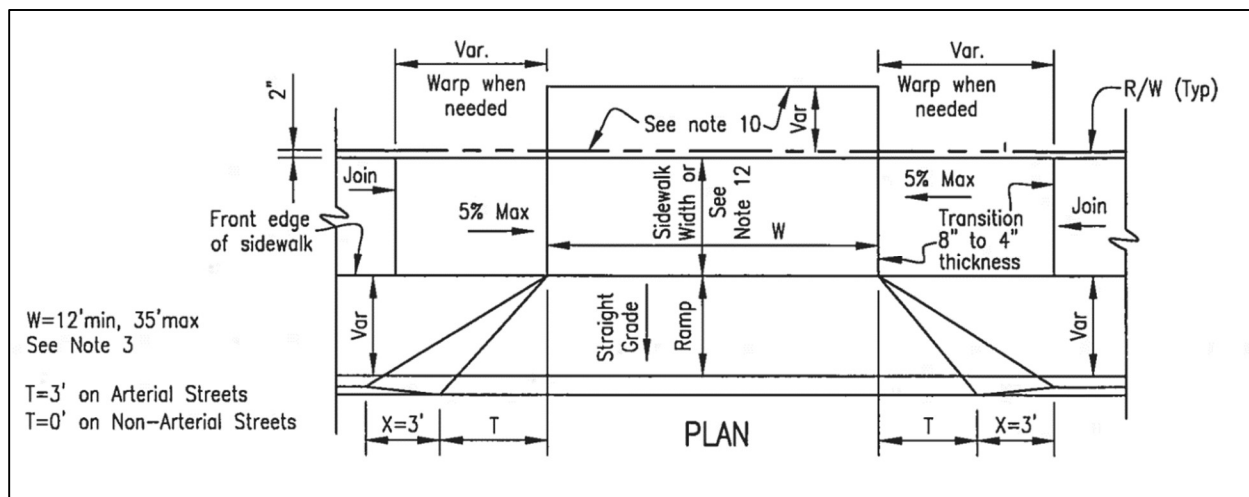

Source: (<https://www.cityoforange.org/DocumentCenter/View/766/Standard-Plan-115-Commercial-Driveway-Apron-PDF>)

Figure 4-2: City of Orange Department of Public Works Standard Plan 115 Commercial Driveway Apron

4.1.3 Pipelines and Utilities Routing

Figure 4-3 and Figure 4-4 show the proposed pipelines for Site Master Plan Alternatives 1 and 2. The following are features common to all alternatives:

- 16-inch underground pipeline connecting to the existing 12-inch pipe stub to connect the groundwater extraction pump located inside the pump station to the bag filters.
- 16-inch aboveground pipeline downstream of the antisiphon loop along the existing security wall above ground on concrete supports.
- Electrical utilities and signal cables to the bag filters, IX vessels, sump pump, and lighting will be routed through buried conduit.
- 16-inch piping connecting the particulate filters to the IX vessels.

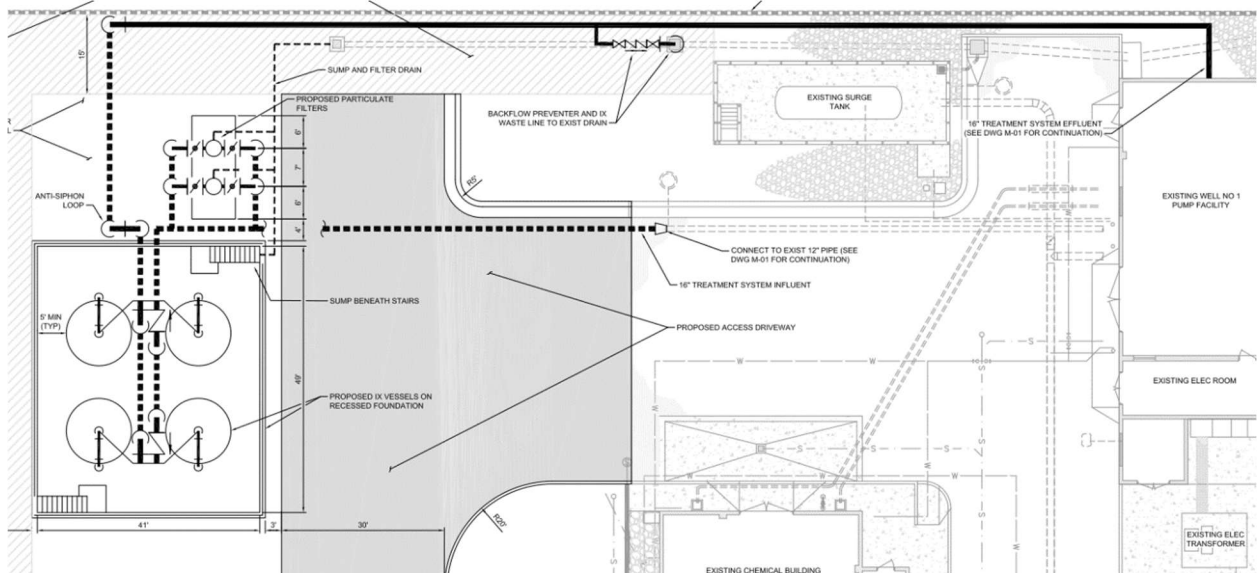

Figure 4-3: Pipelines Routes for Site Master Plan Alternative 1

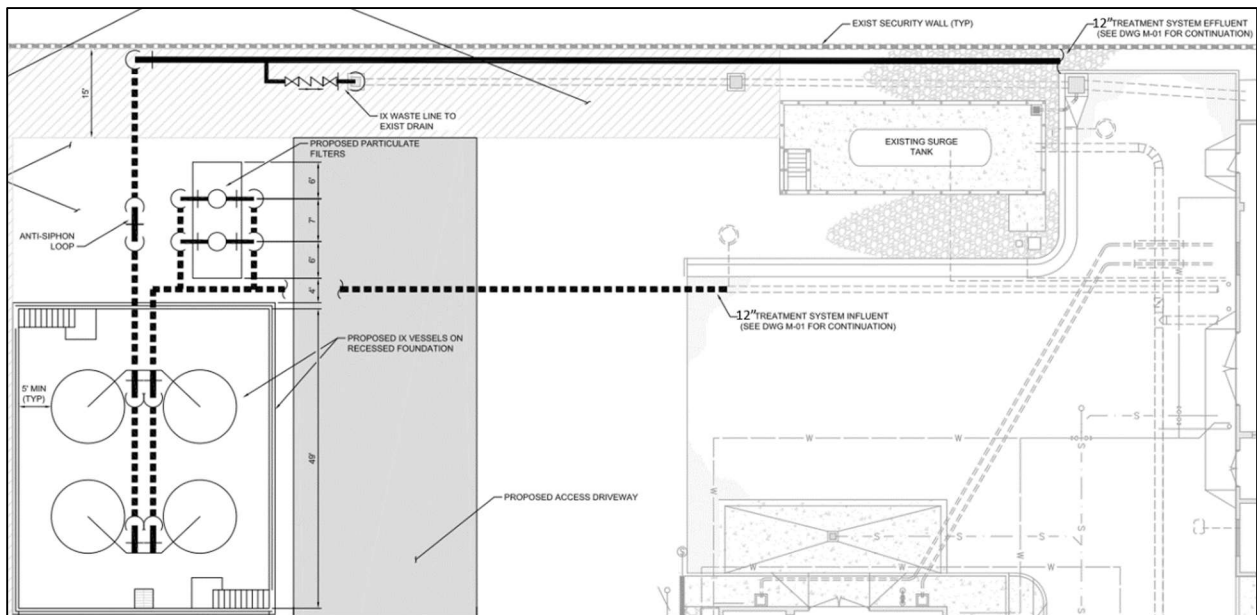

Figure 4-4: Pipelines Routes for Site Master Plan Alternative 2

Figure 4-5 shows the proposed route for the ammonia and hypochlorite, which will be routed underground in double-walled pipes. The pipes will be installed with upslope to drain any potential chemical spill back to the existing chemical distribution boxes which contain leak detection systems. The existing sodium hypochlorite and aqueous ammonia feed pumps are rated for a maximum backpressure of up to 125 psi which will be sufficient to feed the chemicals in the discharge line (approximately 20 psig).

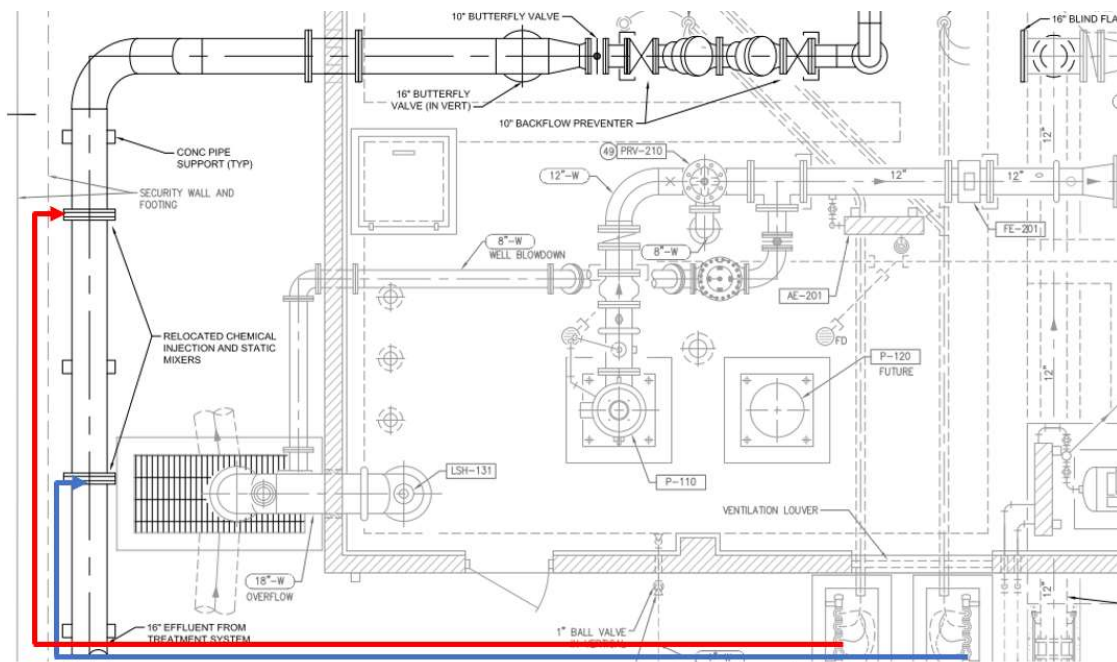

Figure 4-5: Route for Chemical Feeds To Injection Points Relocated Outside of Pump Station

4.2 Civil Design Criteria

Table 4-1 below lists the key design criteria to be used in the civil design.

Table 4-1: OPA-1 Project Civil Design Criteria

Project Component	Criteria	Design Requirement
Stormwater Management	Conveyance and Storage Capacity	Design for a 10-year storm 24-hour duration recurrence interval.
	Grading	Drainage toward stormwater drainage inlets.
	Treatment	Comply with MS4 and NPDES discharge requirements – if required.
	Water Quality Management Plan (WQMP)	If the project disturbs an area greater than 5,000 SF then a stormwater treatment devices will have to be included into the site drainage design (see https://cityoforange.org/DocumentCenter/View/1051/Your-Project-and-a-WQMP-PDF?bidId=). A possible option is the installation of a Contech StormFilter unit at that site to remove oil, grease, sediment, and other contaminants from stormwater runoff similarly that what was included in the design of the Eastwood Recycled Water Pump Station.
	Waste Conveyance Capacity.	The existing storm drain capacity was evaluated in Appendix H which verified that additional waste flows from the IX vessels produces during filter to waste can be conveyed.
Finished Ground Loading	Finished paved surface surrounding the IX vessels and driveway	Provide necessary ground improvements to allow for asphalt of sufficient strength to withstand trucks and truck movement for the routine change of IX resins. Portable mats are needed for heavy-duty crane equipment.

5. Mechanical Design

5.1 Treatment System Description

The existing well OPA-1 is currently piped to an existing clear well, which is used as a source of influent water that is chlorinated and pumped by booster pumps to distribution. Modifications to the system to treat water from OPA-1 for PFAS included the following:

- Water from OPA-1 will be redirected via pipeline to the treatment system.
- Two bag filter housings will be used for filtration of particulates from influent water. Due to long lead times, the bag filters may be preordered by OCWD prior to the start of construction. Filter elements will be changed when the differential pressure across the filters approaches 15 psid.
- Two pairs of IX vessels containing IX resin. Each pair of vessels will be operated in a lead-lag arrangement. Periodic sampling will be conducted at the influent, midpoint, and effluent of the vessels. Midpoint sampling results will be used to determine when changeout of resin in the lead bed is required. After the lead bed is changed, the order of flow through the vessels will be changed so that the bed with fresh resin becomes the lag bed. Manual valves will be used for changes in flow direction between the vessels. Lifespan of the resin varies based on water chemistry and other factors, but according to a pilot study conducted by OCWD, the resin lasted 175,000 bed volumes (based on a 2-minute EBCT). Based on these results, the resin life is approximately one year based on 24-hour per day operation. However, based on a bed volume of 424 cubic feet in the lead vessel and 1,000 gpm, it will likely have a longer EBCT (approximately 3.18 minutes), which could extend the media life. Vessels for this project have been prepurchased by OCWD.
- Treated water will then be chlorinated and flow back to the existing clear well. The existing booster pump system will be used to pump water to distribution.
- Water that is not potable that will be produced from forward flushing IX resin or from other processes will be discharged to the storm drain under an existing national pollution discharge elimination system (NPDES) permit. This nonpotable water will first flow through a backflow preventer prior to discharge to the storm drain.

5.2 Mechanical Design Description

The mechanical design will include the following elements:

- Upgrades to the existing groundwater extraction pump
- Sizing and selection of the bag filtration system
- Selection of the number of IX vessels
- Design of the antisiphon loop
- Sizing and selection of the sump pump inside the IX vessels pit
- Piping connections
- Pipe sizing, material selection, and appurtenances
- Hydraulic calculations

5.2.1 Groundwater Extraction Pump Upgrade

The existing groundwater extraction pump will be upgraded to meet the new hydraulic conditions. Based on software provided by Flow Serve and communication with FlowServe, it has been confirmed that the upgrade is possible. The pump will require a new bowl, bearing, impeller, collet, bowl shaft, line shaft, stuffing box, and motor. Table 5-1 shows the design criteria for the existing pump and two alternatives for the upgraded pump depending on the number and type of vessels that will be selected. The pump curves for the new hydraulic conditions and the correspondence with Flow Serve and local rep DXP Enterprises are included in Appendix D.

Table 5-1: OPA-1 Groundwater Pump: Existing versus Upgraded Pump

Criteria	Existing Pump	Upgraded Pump Evoqua HP1220CIX two pairs
Pump Type	Vertical Turbine	Vertical Turbine
Pump Mfr., Model	FlowServe 15EMM	FlowServe 15EMM
Number of pumps	One - duty	One - duty
Capacity	2,000 gpm	2,000 gpm
Total Dynamic Head	409 ft	486 ft (max pressure loss IX + Particulate Removal)
Hydraulic power	207 hp	308 hp
Number of stages	4	5
Pump Speed	1775 RPM	1775 RPM
Discharge region of discharge head MAWP	300 psig	285 psig
Pump / Overall Efficiency at point of duty	82.9%	79.8%
Impeller diameter	11.58 inches	11.44 inches
Shaft diameter	1.69 inches	1.69 inches
Pump Materials	Per submittal 017-R3	No change
Electric Motor Type	Vertical hollow shaft TEFC	Vertical hollow shaft TEFC
Motor Size	250 hp	350 hp
Motor Frame	449PH	449PH
Bearing Type	Vesconite Bearings	Vesconite Bearings

5.2.2 Bag Filtration System

A bag filtration system (Figure 5-1) will be installed upstream of the IX vessels to limit the amount of particulate material entering the IX vessels that is generated primarily during each start of the groundwater extraction pump. The bags are replaced by opening the cover on top of the vessels (a head lift will be integral to the unit). A platform will be provided for operator access.

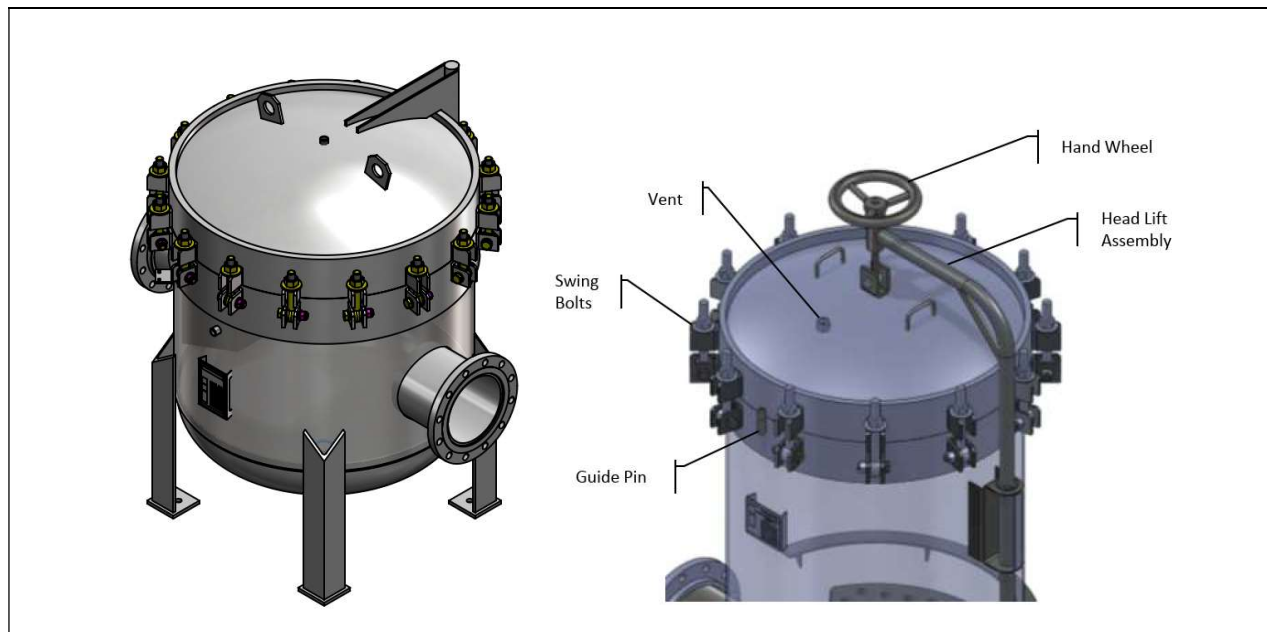

Figure 5-1: Bag Filter Pressure Vessel - Fil-Trek Corporation LP Series

The design criteria for the bag filters are listed in Table 5-2. Cut sheets and correspondence with one of the vendors (Fil-Trek) are included in Appendix E.

Table 5-2: Prefiltration System for OPA-1

Criteria	Design Requirement
Number of bag filters vessels	Two
Treated flow	approximately up to 2,250 gpm per vessel filter
Operation	parallel with the ability to operate one vessel while the second is being serviced
Bag filter vessel type	Pressure vessel ASME Section VIII Div.1 (Filtrek-Or Equal)
Bag filter vessel size	Diameter: 42 inches (approximately) Height: 5 feet, 3 inches
Vessel Material	304/L
Bag Filter Capacity	18 x Size 2 baskets
Recommended changeout head loss	15 psi
Bag Filter Size / Filter Media	5 micron / polypro
Bag filter size	Outside diameter 7 inches / Length 32 inches
Flange size	10"
Drains	2" and ½" drains used during bags change out – drains will be connected to the storm drain

5.2.3 IX Vessels

The IX vessels shown in Figure 5-2 are the selected IX vessels. Table 5-3 summarizes the design criteria for the system. Cut sheets and head loss curves provided by Evoqua are found in Appendix F.

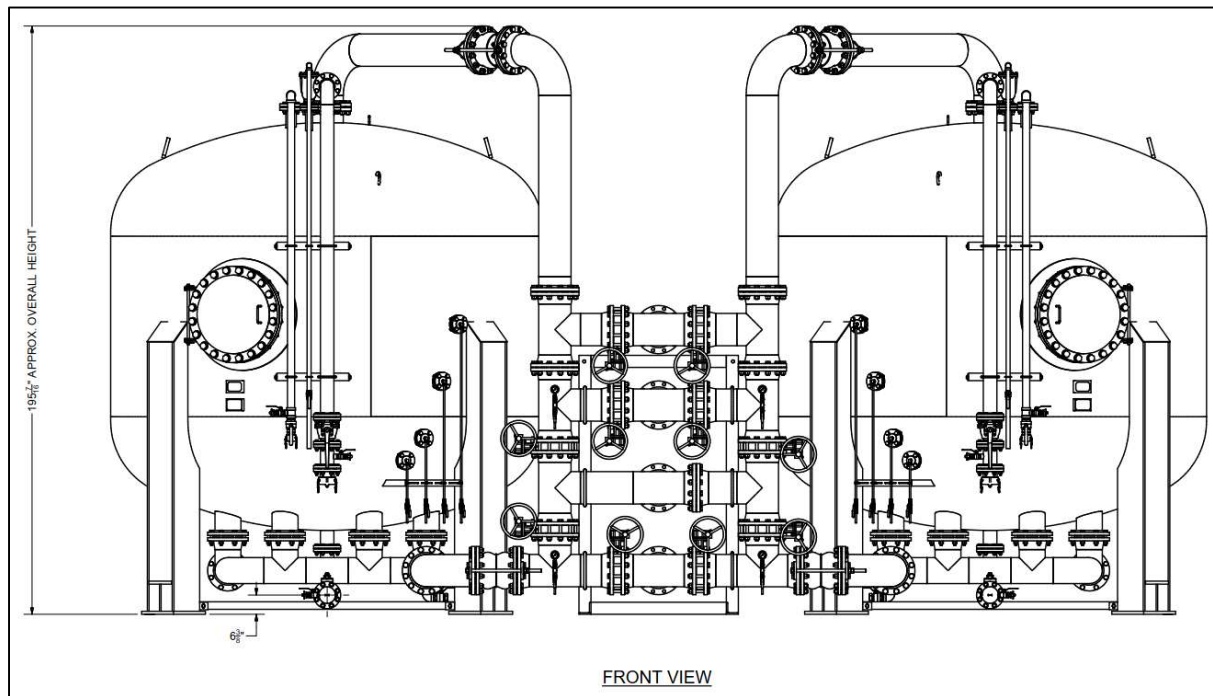

Figure 5-2: IX Vessels Skid - Evoqua Model HP1220CIX

Table 5-3: IX Vessels Design Criteria

Criteria	Design Requirement
Vessel Model	Evoqua HP1220CIX
Vessel Piping Size	10 inches
Number of vessels	Four (two skids with two vessels each)
Capacity	1,600 gpm max per pair of vessels 3,200 gpm max combined capacity
Size	Diameter: 12 feet Height: 16 feet, 4 inches (top of influent pipe)
Operation	Both pairs working in parallel lead / lag within each pair
Resin Fill for Two-minute EBCT	424 ft ³
System Clean Bed Head loss @ 2,000 gpm	Approximately 20 psig per vessel pair
System "Dirty" Head loss @ 2,000 gpm	Approximately 30 psig per vessel pair
Backwash supply (for use after each resin change to redistribute the media)	Untreated groundwater

The IX changeout is done with a tanker truck. The resin connections for the truck are at the bottom in the middle of the trailer. The ideal length of hose to connect to the vessels is 40 feet, but it is possible to use

hoses as long as 200 feet. The connection for the IX vessels is through a 4-inch camlock connection located on a side of the vessel at approximately 4 feet from the ground. The resins are fed inside the vessel from a 4-inch connection located on top of the vessels. The design will include a minimum space of 5 feet from the vessels to the walls of the pit. More space is provided (approximately 9.5 feet to the wall) on the side of vessels with the camlock.

5.2.4 Sump Pump System

The IX Vessels pit will require the installation of a sump and a sump pump for preventing the ponding of precipitation. A sump will host submersible pumps. A submersible duplex sewage pump system is recommended (Figure 5-3). A minimum flow of approximately 25 gpm is recommended based on a hundred-year storm. A fiber grate (see IRWD 2021, Construction Manual, STD. DWG. G-6 Detail B) is recommended to keep the large object out of the sump and minimize the risk of clogging the grate.

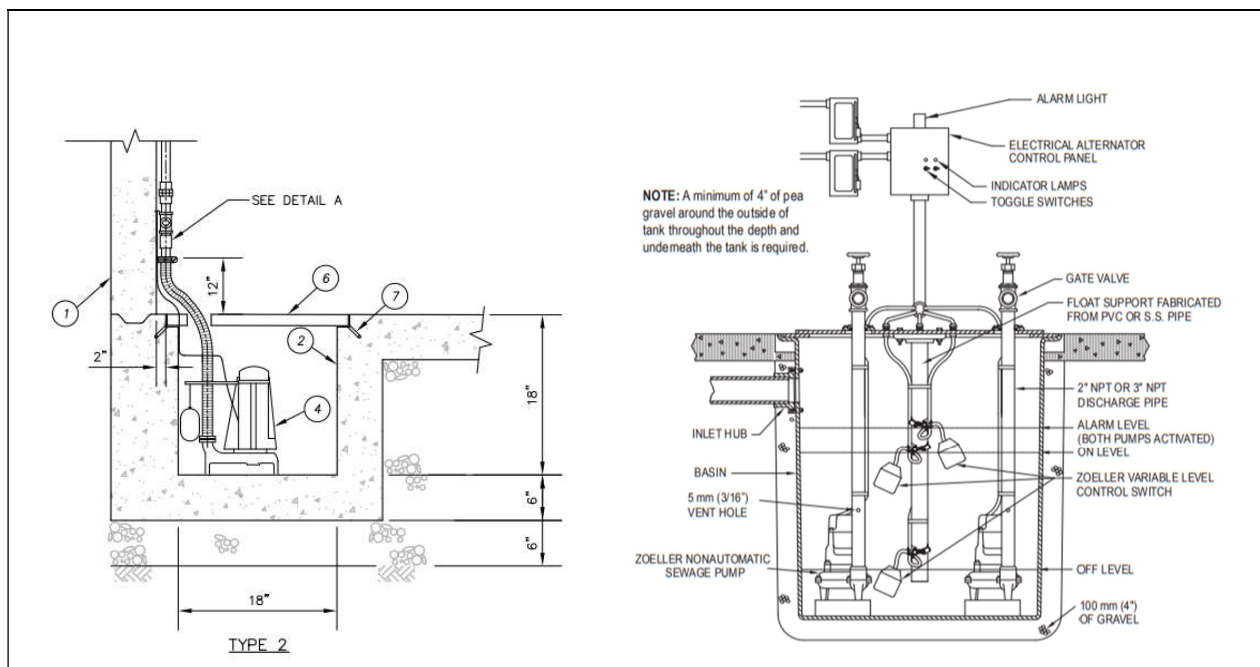

Figure 5-3: Duplex Sump Pump System with Typical Installation – (left IRWD installation detail 2021, Construction Manual, STD. DWG. G-6, right Zoeller duplex sump pump assembly)

Cut sheets for one of the pump vendors (Zoeller) and pump curves are found in Appendix G. Table 5-4 lists the main design parameters for the suggested pump.

Table 5-4: IX Vessels Pit Sump Pump

Criteria	Sump Pump
Pump Type	Submersible sump pump
Pump Mfr., Model	Zoeller – Model 98 or equal
Number of pumps	Two: duty + standby
Capacity	40 gpm
Solids Handling	1/2" (12 mm) spherical solids
Total Dynamic Head	15 feet (approximately)
Pump Speed	1725 RPM
Voltage/Phase/Hz/Amps	115 or 230 V/1 Ph/60HZ/4.7-9.4 amps
Impeller Type	Non-clogging vortex
Impeller Material	Engineered plastic
Pump Materials	Motor and pump casing – cast iron Motor shaft – AISI 1215 cold roll steel
Electric Motor	Oil-filled with Class B insulation
Motor Rating	1/2 hp

5.2.5 Piping and Appurtenances

The following tables provide an overview of proposed piping and appurtenances.

Table 5-5: Piping Schedule

System	Fluid	Piping	Valves
W	Water	4" and larger buried yard piping: cement mortar lined and coated (CMLC), per lined and coated in the shop per AWWA C205, and as specified in Section 15076 IRWD .	
		4" and larger exposed yard piping: Yard piping cement mortar lined and coated (CMLC), per lined and coated in the shop per AWWA C205, and as specified in Section 15076 IRWD Std. Spec 15053.	4" and Larger buried or exposed: Butterfly per IRWD Std. Spec 15100 or resilient wedge gate per IRWD Std, Spec 15100.
		4" and larger exposed pump station piping: Fusion Epoxy Lined and Painted Coating Steel Pipe per IRWD STD. Spec 15053.	
		3-1/2" and less exposed: Copper tubing, type L, hard annealed per IRWD Std. Spec 15057.	3-1/2" and less exposed: Bronze gate per IRWD Std. Spec 15100 or bronze ball per IRWD Std Spec 15100.
		3-1/2" and less buried: Copper tubing, type K, with tape coat, hard or soft annealed per IRWD Std. Spec 15057.	None
		1" and 1/2" exposed and buried for well prelude: 316 Stainless Steel pipe and fittings, SCH 40, threaded ends per Spec 15065, tape coat buried pipe.	316 Stainless Steel Ball, Check, Solenoid, and PRV valves.

System	Fluid	Piping	Valves
SHC	12.5% Sodium Hypochlorite	All sizes exposed: CPVC, SCH 80, solvent weld per Spec 11520.	All sizes exposed and in vaults: CPVC ball with vented ball per IRWD Std. Spec 15100.
		All sizes buried: PFA tubing inside CPVC SCH 40 conduit with long sweep elbows at each turn.	Buried Conduit shall be 4", conduit in pump room shall be 3"
AA	29.0% Aqueous Ammonia	All sizes exposed: 316 Stainless Steel pipe and fittings, SCH 40, threaded ends per Spec 15065.	All sizes exposed: Stainless Steel ball, threaded ends per IRWD Std. Spec 15100.
		All sizes buried: PFA tubing inside CPVC SCH 40 conduit with long sweep elbows at each turn.	Buried Conduit shall be 4", conduit in pump room shall be 3"
SHD and AAD	Sodium Hypochlorite Drain and Aqueous Ammonia Drain	All sizes buried: CPVC, SCH 80 pipe per Spec 11520 with CPVC, SCH 40 DWV fittings	None
SS	Sanitary Sewer	All sizes buried: ASTM D3034 CPVC Gravity Sewer Pipe, SDR 26, JM Eagle Ring-tite or approved equal.	None

Table 5-6: Yard Piping

System	Pipe Size	Service Type	Material	Length
W	10"	Exposed Pipe	Cement mortar lined and coated steel	42 ft
		Buried Pipe	Cement mortar lined and coated steel	74 ft
W	12"	Exposed Pipe	Cement mortar lined and coated steel	45 ft
		Buried Pipe	Cement mortar lined and coated steel	529 ft
W	16"	Exposed Pipe	Cement mortar lined and coated steel	161 ft
		Buried Pipe	Cement mortar lined and coated steel	278 ft

Table 5-7: Valves

System	Pipe Size	Type	Manufacturers	No. of Valves
W	2"	Air/Vacuum Release	per IRWD 2021, Construction Manual Spec 15089	6
W	10"	Butterfly Valves	per IRWD 2021, Construction Manual Spec 15100	14
		Backflow Preventer	per IRWD 2021, Construction Manual Spec 15112	2
		Gate Valves	per IRWD 2021, Construction Manual Spec 15100	2
W	12"	Butterfly Valves	per IRWD 2021, Construction Manual Spec 15100	1
W	16"	Butterfly Valves	per IRWD 2021, Construction Manual Spec 15100	2
		Check Valve	per IRWD 2021, Construction Manual Spec 15100	1

Note: These valves do not include vessel valve trees.

5.2.6 HVAC Evaluation

To verify that the impacts of proposed changes does not require additional HVAC capacity AECOM has prepared an HVAC analysis shown in Appendix H. Based on the proposed increase of the pump motor from 250 HP to 350 HP and the existing HVAC capacities, the change in temperature of both the electrical room and the pump room are negligible. Switchgear heat losses would increase the electrical room temperature by 0.03°F and the new motor would increase the pump room temperature by 1.1°F, keeping the room temperature under the typical rated design temperature of 104°F assuming an ambient design temperature of 94°F.

5.3 Hydraulic Evaluation

5.3.1 Treatment System

To review and confirm the operational concept and proposed design criteria, AECOM has prepared a hydraulic analysis of proposed modifications to the existing groundwater extraction pump. The pump selected will meet the new increased pressure demands of the new IX vessels, bag filters, pipelines and valves. The proposed system has been designed to deliver 2,000 gpm of treated groundwater to the clear well located within the existing pump station. The following section provides the hydraulic analysis and validation results for the overall system for the alternative layouts presented in Section 3. The design assumptions (Table 5-8) and results (Table 5-9) are shown below. Hydraulic calculations are presented in Appendix H and Appendix D for pump curves.

Table 5-8: Hydraulic Calculation Assumptions

Criteria	Assumptions
Pumping System	Upgrade existing pump to provide Flow: 2,000 gpm Number of pumps: 1 Duty Pump
Static water level and drawdown level	Based on 10/8/2015 operational data and existing certified pump curve. Suction Side HWL: 99 ft Suction Side LWL: (-8) ft
Pump System Conditions:	Intake Elevation: (-119) ft Discharge Elevation: 307 ft (highpoint in pump piping) Minimum Roughness Factor (C): 130 Maximum Roughness Factor (C): 140 Altitude: 302 ft Water Temperature: 60° F

Table 5-9: Hydraulic Analysis Summary

Criteria	Alternative 2 (Section 3.2.2)
NPSH _a :	73.8 ft
System Losses:	100 ft
Station & System Losses:	113 ft
Design Pumping Head:	373 ft
Total Head:	486 ft

5.3.2 Landscaping Water Supply

The existing irrigation 1½-inch header can be utilized to supply water to the proposed areas of landscaping that require irrigation water supply. The utilization of timers to maintain a zone-by-zone watering schedule will allow for the existing system header to meet the new irrigation water supply requirements.

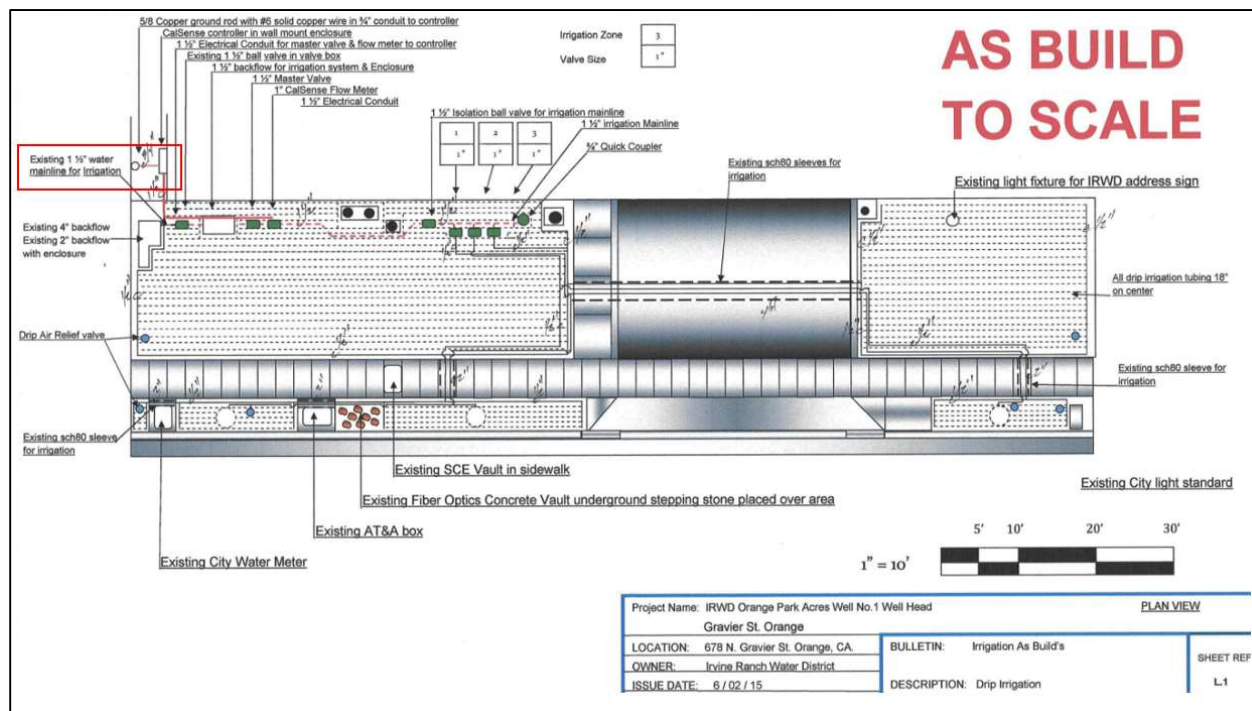

Figure 5-4: Available Connection to Existing Irrigation Header for Landscaping Water Supply

5.4 Mechanical Design Codes and Standards

1. California Mechanical Code, latest edition.
2. California Plumbing Code, latest edition.
3. Uniform Fire Code (UFC)
4. California Electrical Code, latest edition.
5. California Building Code 2016 (CBC)
6. American Society for Testing and Materials (ASTM)
7. American Public Health Association
8. American National Standards Institute (ANSI)
9. American Society of Mechanical Engineers (ASME)
10. American Water Works Association (AWWA)
11. American Society of Heating, Refrigerating, and Air Conditioning Engineers (ASHRAE)
12. American Welding Society (AWS)
13. National Fire Protection Association (NFPA)

14. National Electrical Manufacturers Association (NEMA)
15. Antifriction Bearing Manufacturers Association (ABMA)
16. American Gear Manufacturers Association (AGMA)
17. Hydraulic Institute (HI)
18. Underwriters Laboratories (UL)

5.5 Structural Design

The structural design will include the following elements:

- Sizing of concrete slabs and walls
- Selection of concrete mixtures
- Selection of rebar and other steel reinforcing materials
- Sizing and selection of stairs and railings
- Sizing of pipe supports
- Seismic calculations for structures and review of seismic calculations from vendors
- Selection of masonry wall materials and foundations
- Requirements for compaction of subgrade

5.6 Structural Design Requirements

Table 5-10 lists the structural design criteria.

Table 5-10: OPA-1 PFAS Project Structural Design Criteria

Parameter	Design Criteria / Coefficient
General	Per IRWD Design Standards
Design Loads	Fixed ladders: 300 lb concentrated load Handrails, guardrails, and grab bars: 50 plf uniform load / 200 lb concentrated load Sidewalks, vehicular driveways: 250 psf uniform load / 8,000 lb concentrated load Concrete floor slabs-on-grade: 250 pounds per square foot (psf) uniform load / and 3,000-pound concentrated load
Wind Loads	Exposure (urban area with building heights less than 30 ft): B Basic wind speed, mph: 105 (3-s gust) Directionally Factor: $K_d = 0.85$ Topographic Factor: $K_{ZT} = 1.0$

Parameter	Design Criteria / Coefficient
Earthquake Loads	<p>Seismic Risk Category III Seismic Importance Factor, I_e 1.25 Spectral Response Acceleration Parameter, S_S 1.401 Spectral Response Acceleration Parameter, S_1 0.499 Site Class D Site Coefficient F_a 1.0 Site Coefficient F_v 1.8 Spectral Acceleration Parameter, S_{DS} 1.222 Spectral Acceleration Parameter, S_{D1} 0.770 Seismic Design Category D Response Modification Coefficient, R Ref ASCE 07-16 Tables 12.2-1 and 15.4-2 Overstrength Factor, Ω Ref ASCE 07-16 Tables 12.2-1 and 15.4-2</p>
Equipment Anchorage	<p>Anchorage of equipment shall be based on CBC Chapter 16 and ASCE 7-16 Chapters 13 and 15 using the site-specific seismic parameters specified in this chapter plus Vertical seismic forces in accordance with ASCE 7-16 Chapter 12. Anchorage design shall be in accordance with ACI 318-14 Chapter 17. Anchorage of tanks shall be in accordance with ASCE 7-16 Section 15.7.5 and ACI 318-14 Chapter 17. All equipment shall be certified by the manufacturer as having been designed to internally resist seismic loading, meeting the requirements of ASCE 7-16 Chapter 13 and Chapter 15.</p>
Structural Materials	<p>Type of Concrete: Tank pit retaining walls and foundation, masonry wall footings. equipment foundations: Type A Sidewalks, curbs, bollards, and other non-structural concrete: Type E</p> <p>Structural concrete conforms to ACI 318-14 $f'_c = 4,000$ psi – all structural applications. $f'_c = 3,250$ psi – electrical duct banks, reinforced thrust blocks, curb and gutter and drainage structures. $f'_c = 2,000$ psi – pipe encasements, and concrete fill for structural foundations. $f'_c = 5,000$ psi – Precast concrete.</p> <p>Reinforcement: Reinforcing steel bars ASTM A706 Grade 60</p> <p>Masonry Structures: Normal weight concrete masonry units per ASTM C90 with a minimum compressive strength of 2,000 psi, so that total masonry assemblage shall have a minimum compressive strength of 1,500 psi at 28 days. Masonry structures will be designed with open ended concrete masonry units and be fully grouted.</p> <p>Structural Tests and Inspections Special inspections and testing in accordance with CBC Chapter 17 will be required for foundation excavations, and concrete and masonry construction.</p>

5.7 Structural Design Codes and Standards

1. California Building Code (CBC) 2019.
2. Minimum Design Load for Buildings and Other Structures, ASCE Standard, ASCE/SEI 7- 16, American Society of Civil Engineers, 2016.
3. Building Code Requirements for Reinforced Concrete (ACI 318-14) and Commentary (ACI 318R-14), American Concrete Institute
4. Building Code Requirements for Masonry Structures and Specification for Masonry Structures, TMS 402/602-16, The Masonry Society, 2016.
5. International Code Council (ICC) Evaluation Service Reports for manufactured structural components
6. Applicable state and local codes.

6. Architectural and Landscaping Design

The architectural design will include matching the existing perimeter walls. The style of the perimeter walls will also be composed of the same decorative concrete masonry unit (CMU) used for the buildings. The new access gate will match the style of the existing gate and simple metal pickets with a backing of decorative perforated metal to block the view into the site. The work will be also providing architectural screening to hide the new equipment and piping from the neighboring properties. The style of these screens will be decided upon during future discussions with IRWD. The architectural work will also address code and safety elements of the design.

The landscaping will match the style of the existing landscaping. Inspired by a walled-in pocket park, the subtle look of the facility will serve as a backdrop for layers of proposed lush, variegated plantings along North Gravier Street, softening the overall look from the street. The goal is to have the facility be obscured by layers of plantings and to mitigate noise.

6.1 Architectural Design Requirements

Table 6-1 lists the architectural design criteria per Cal-OSHA and the CBC.

Table 6-1: OPA-1 PFAS Project Architectural Design Criteria

Parameter	Design Criteria / Coefficient
Stairs	Stairs shall meet Cal-OSHA minimum (1910.25 & 1910.28) - preferably CBC requirements (3214). The two sets of stairs in the pit to be located on opposite ends, to meet the common path of travel limitations per California Building Code
Guardrail	42" minimum height guardrail around the pit edges, meeting Cal-OSHA requirements as a minimum, - preferably CBC requirements

6.2 Architectural Codes and Standards

1. California Code of Regulations (CCR) Title 24, Part 2 – 2019 California Building Code (CBC)
2. California Code of Regulations (CCR) Title 8, Division 1, Chapter 4 (California)
3. California Occupational Safety and Health Administration [Cal-OSHA]

7. Noise Requirements

The OPA-1 facility will meet City of Orange Noise Ordinance 17-74 (Figure 7-1) (https://www.cityoforange.org/DocumentCenter/View/3369/AppendixE_Noise-Modeling?bidId=), which requires a maximum of 55 dBA between 7 AM to 10 PM and 50 dBA between 10 PM to 7 AM at the property line. For the existing facility, these requirements have been met by providing noise suppression materials for critical noise generators. The goal of the current project is that the new facilities will not increase the current sound at the site.

The new equipment to be placed outdoors is not expected to be a significant source of noise as there are no new pumps or other mechanical components with moving parts. This includes IX vessels and bag filters. As discussed in Section 3.3.2., although the check valves are of the “silent” type, relocation of the backflow preventer outdoors could result in some occasional noise. If relocation outdoors is selected, sound attenuation is recommended to limit the impact to the neighboring houses.

According to the 2013 Noise Technical Report (URS), the noise levels generated by normal pump station operations was estimated to be 43 dBA L50 at the properties located north and west of the proposed Project site. The noise levels from operation of the existing pump station do not exceed the City of Orange 50 dBA L50 nighttime noise standard. The increase in size of the motor for the well pump is not expected to increase the sound power produced as illustrated in Figure 7-1 where the typical noise value for the existing motor frame (449) and the new motor frame (5800) are compared.

However, once the design alternatives for vessels number and pump size motor have been selected, an updated noise study to assess background levels and noise sources will be conducted to determine if additional noise mitigation measures are to be implemented.

NOISE LEVELS: VERTICAL MOTORS 180-9600

The following are the Nidec Motor Corporation noise levels for vertical motors. The levels are measurements in dB(A) per ANSI 12.51 and NEMA MG-1, corrected to a free field under 60 Hz sine wave power at a reference level of 0.0002 dyne/cm². These are average expected values based on no-load testing and should not be guaranteed.

FRAME	RPM	WP-I		WP-II		TEFC/XP Standard & Energy Efficient		TEFC/XP Premium Efficient	
		Sound Pressure	Sound Power	Sound Pressure	Sound Power	Sound Pressure	Sound Power	Sound Pressure	Sound Power
180	3600	70	78	n/a	n/a	75	83	75	83
	1800	60	68	n/a	n/a	65	73	60	68
	1200 & slower	55	63	n/a	n/a	60	68	60	68
210	3600	75	78	n/a	n/a	75	83	75	83
	1800	60	68	n/a	n/a	65	73	65	73
	1200 & slower	55	63	n/a	n/a	60	68	60	68
250	3600	75	83	n/a	n/a	80	88	75	83
	1800	70	78	n/a	n/a	70	78	65	73
	1200 & slower	60	68	n/a	n/a	60	68	60	68
280	3600	75	84	n/a	n/a	80	89	80	89
	1800	70	79	n/a	n/a	70	79	70	79
	1200 & slower	60	69	n/a	n/a	65	74	65	74
320	3600	75	84	n/a	n/a	80	89	80	89
	1800	65	74	n/a	n/a	70	79	70	79
	1200 & slower	65	74	n/a	n/a	65	74	65	74
360	3600	75	84	n/a	n/a	85	94	80	89
	1800	65	74	n/a	n/a	75	84	75	84
	1200 & slower	65	74	n/a	n/a	70	79	65	74
400	3600	80	90	n/a	n/a	85	95	80	80
	1800	70	80	n/a	n/a	75	85	75	85
	1200 & slower	65	75	n/a	n/a	70	80	65	75
440	3600	80	90	n/a	n/a	90	100	80	90
	1800	70	80	n/a	n/a	80	90	75	85
	1200 & slower	70	80	n/a	n/a	75	85	65	75
447	3600	n/a	n/a	n/a	n/a	90	100	85	95
	1800	85	95	n/a	n/a	80	90	75	85
	1200 & slower	80	90	n/a	n/a	75	85	70	80
449	3600	n/a	n/a	n/a	n/a	90	102	92	105
	1800	n/a	n/a	-	-	90	102	92	105
	1200 & slower	n/a	n/a	-	-	85	97	87	100
5000	3600	91	103	91	103	90	103	91	103
	1800	86	98	86	93	90	103	86	103
	1200 & slower	80	93	80	93	85	98	80	93
5800	3600	n/a	n/a	n/a	n/a	97	109	97	109
	1800	n/a	n/a	n/a	n/a	92	104	92	104
	1200 & slower	n/a	n/a	n/a	n/a	92	104	92	104
6812 (TE)	3600	n/a	n/a	n/a	n/a	n/a	n/a	n/a	n/a
	1800	n/a	n/a	n/a	n/a	92	108	92	108
	1200 & slower	n/a	n/a	n/a	n/a	92	108	92	108
6800-8000	3600	n/a	n/a	n/a	n/a	n/a	n/a	n/a	n/a
	1800	90	105	85	100	n/a	n/a	n/a	n/a
	1200 & slower	85	100	80	95	n/a	n/a	n/a	n/a
9600	3600	n/a	n/a	n/a	n/a	n/a	n/a	n/a	n/a
	1800	REFER TO OFFICE		REFER TO OFFICE		n/a	n/a	n/a	n/a
	1200 & slower	90	105	85	100	n/a	n/a	n/a	n/a

Measurements are reported at 3 feet for NEMA[®] frames, 5 feet for TITAN[®] frames (449 and larger). Refer to the Inquiry Group for Noise Quotation Guidelines and Octave Band Analysis Chart.

Figure 7-1: Typical Noise Values for Nidec Vertical Motors - 2020 Product Specifications

8. Electrical Design

The electrical scope consists of upgrading the existing 250-hp motor starter (rated for 300 hp) with a new 350-hp motor starter (rated for 400 hp). The scope also includes providing power, lighting, and controls to the treatment system equipment, and providing power and controls for a new electric gate.

8.1 Electrical Room Upgrades

The existing 300-hp solid-state starter section, located in the electrical room motor control center, will be removed and replaced with the new 400 -hp solid-state starter section. The new power conduits from the motor control center to the new motor will be installed overhead, as shown on sheets E-01 through and E-05. The remote instruments such as pressure switches and the prelube flow switch control wiring will be intercepted and relocated to the new solid-state starter. The new motor starter will also include the SEL-710-5. The existing monitor vibration panel will be used to monitor vibration to the new 350 hp motor. New cables will be installed from the existing vibration panel to the new 350 hp motor. The new cables will be installed in existing conduits that will become available after the existing 250 hp motor and associated wiring has been removed.

Rockwell Automation is the manufacturer for the existing 250hp motor starter. AECOM suggests that the same manufacturer is used for the new 400hp motor starter for the following reasons:

1. The new motor starter should fit within the same space as the existing 250hp motor starter.
2. The control wiring input/outputs for field instruments for the new starter need to match the existing connections so the existing wiring can be re-used.
3. The control wiring for the PLC inputs/outputs for the new starter should match the existing connections so the existing wiring can be reused.

8.2 Instrumentation

Valves and instruments are shown in the process flow diagram enclosed with the preliminary drawings set in Section 13. It is proposed that all new valves will be manually operated and will be exercised infrequently for operation of the system. The existing valve on the discharge of the existing well pump will remain motor-operated.

Particulate filters will be equipped with differential pressure transmitters providing an alarm when the pressure exceeds a set value (assume 15 psi) for the media. IX vessels will be equipped with pressure indicators and differential pressure transmitters that provide an alarm when the pressure exceeds a set value (assume 10 psi) for the media.

The sump will include level switches to control operation of the sump pump. A high-level sensor will trigger the pump to turn on and a low-level sensor will turn off the pump. A high-high level sensor will be used to trigger an alarm indicating high level in the pit.

The existing PLC has sufficient spare inputs/outputs to accommodate the new 400-hp solid-state starter as well as new signals from the prefilters and IX vessels.

8.3 Tank Area Lighting

The tank area lighting will consist of LED wallpack lights mounted on the side of the pit wall. The lighting will be manually controlled by three-way switches located near the pit stairs. The pit lighting levels will be

designed to keep illumination within the property and not spill to the neighboring properties. The lighting controls will include photocell and pushbutton holding circuit.

8.4 Site Electric Gate

Power will be provided to a new vehicle electrically actuated gate. The gate will operate as follows:

- A new keypad will be provided for the automated gate operation (if required by IRWD).
- The gate will be activated using a traffic loop with keypads provided on the interior and exterior of the site
- If a photosensor detects an object in the path of the gate while closing, the gate will open and remain open until the proximity card or key switch is re-activated.
- The gate will have an adjustable time delay to close after the last valid card user exits.

9. Utilities

The following utilities are anticipated:

- **Power.** Coordination with Southern California Edison (SCE) will be required. Once the electrical loads are estimated and confirmed, they will be provided to SCE so they can review the design and select the transformer and associated conduit and cable needs. SCE will ultimately schedule the delivery of service.
- **Sewer.** No new sewer connections will be required.
- **Storm Drain.** There is an existing on-site stormwater collection system conveying flow to the existing storm drain that runs along the west property line. The well pump bypass- to- waste line will discharge into an existing storm drain catch basin, and a pipe will convey flows to the 18-inch storm drain at the northwest corner of the property. That storm drain flows toward Prospect Street.
- **Gas.** Not Required
- **Telephone.** No new telephone infrastructure will be required.
- **Utilities Connected to 660 N. Gravier Street.** Utilities to the house on 660 N. Gravier Street will be disconnected and capped. The coordination with the various agencies (SCE, City of Orange, gas, cable, phone) will be included in the bid documents for the contractor to address.

10. Permitting

An encroachment permit from the City of Orange for work in the public right of way to construct the new driveway will be required.

The project team has contacted the City of Orange Public Works Department and no other permit will be required including demolition.

11. Estimate of Probable Costs

Table 11-1 provides a summary of costs for the alternatives presented in Section 3. Cost changes due to alternative piping configurations, electrical, and pump size are presented as line items. The base estimates for Civil/Mechanical/Structural, and Electrical / I&C costs are found in Appendix I.

Table 11-1: OPA-1 PFAS 30% Design Level Estimate - Class 3 - Options Summary

Alternative	Alternative 2
Description	4 Vessels - South End of Property
BODR Reference Section	Section 3.2.3
Civil/Mechanical/Structural	\$2,626,538.05
Electrical /I&C	\$381,278.00
Subtract for shorter pipe length	-
Subtract for smaller vessels pit excavation	
IX Vessels 1220	\$1,038,000.00
Subtract for installation of 2 vessels instead of 4	
Add for increased pump size	-
Total	\$4,045,816.05

Note, costs in Table 11-1 include 7.8% sales tax, 1.3% bonds, 1.5% insurance, 1.5% permits, 10% contingency, and 15% contractor overhead and profit.

12. Project Schedule

13. 30% Drawings

Last saved by: CONNELLY J (2021-05-25) Last Plotted: 2021-05-25
 File name: E:\PROJECTS\06649299 - OCWD ORANGE PARK ACRES WELL NO. 1 PFAS\CAD\IPRELIM\06649299-OPA1PFAS-PRELIM.PFD.DWG

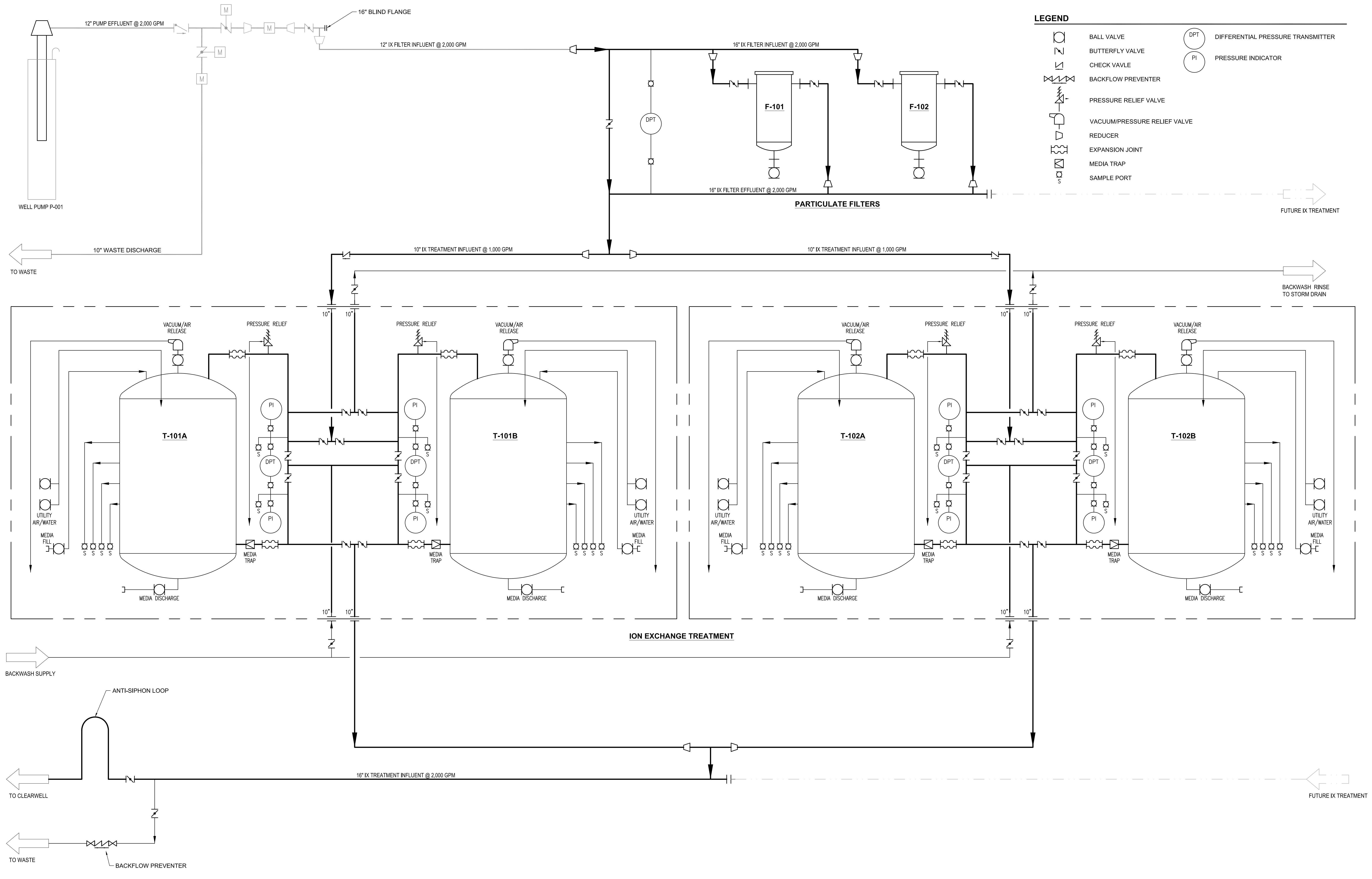

LEGEND

	BALL VALVE		DPT DIFFERENTIAL PRESSURE TRANSMITTER
	BUTTERFLY VALVE		PI PRESSURE INDICATOR
	CHECK VALVE		
	BACKFLOW PREVENTER		
	PRESSURE RELIEF VALVE		
	VACUUM/PRESSURE RELIEF VALVE		
	REDUCER		
	EXPANSION JOINT		
	MEDIA TRAP		
	SAMPLE PORT		

OPA1 PFAS TREATMENT SYSTEM

CODE XXXX

NO.	DATE	REVISIONS	APPROVED

DESIGN: AECOM
 DRAWN: AECOM
 CHECK: AECOM

AECOM

AECOM Technical Services, Inc
 999 Town & Country Road
 Orange, CA 92668
 714.967.4000 tel
 www.aecom.com

ENGINEER STAMP

NAME	<CONSULTANT> PROJECT ENGINEER	DATE
R.C.E.	XXXXX	
NAME	<CONSULTANT> PROJECT MANAGER	DATE
R.C.E.	XXXXX	
NAME	IRWD, PRINCIPAL ENGINEER	DATE
R.C.E.	XXXXX	

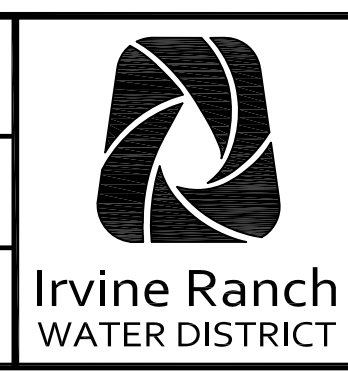

ORANGE PARK ACRES
 WELL NO 1 WELLHEAD FACILITIES
 PFAS TREATMENT SYSTEM

PROJECT NO. XXXX

TREATMENT SYSTEM
 PROCESS FLOW DIAGRAM -
 ALTERNATIVES 1A AND 1B

DRAWING
PFD-01
 2 OF 12
 SHEETS

MAY 2021

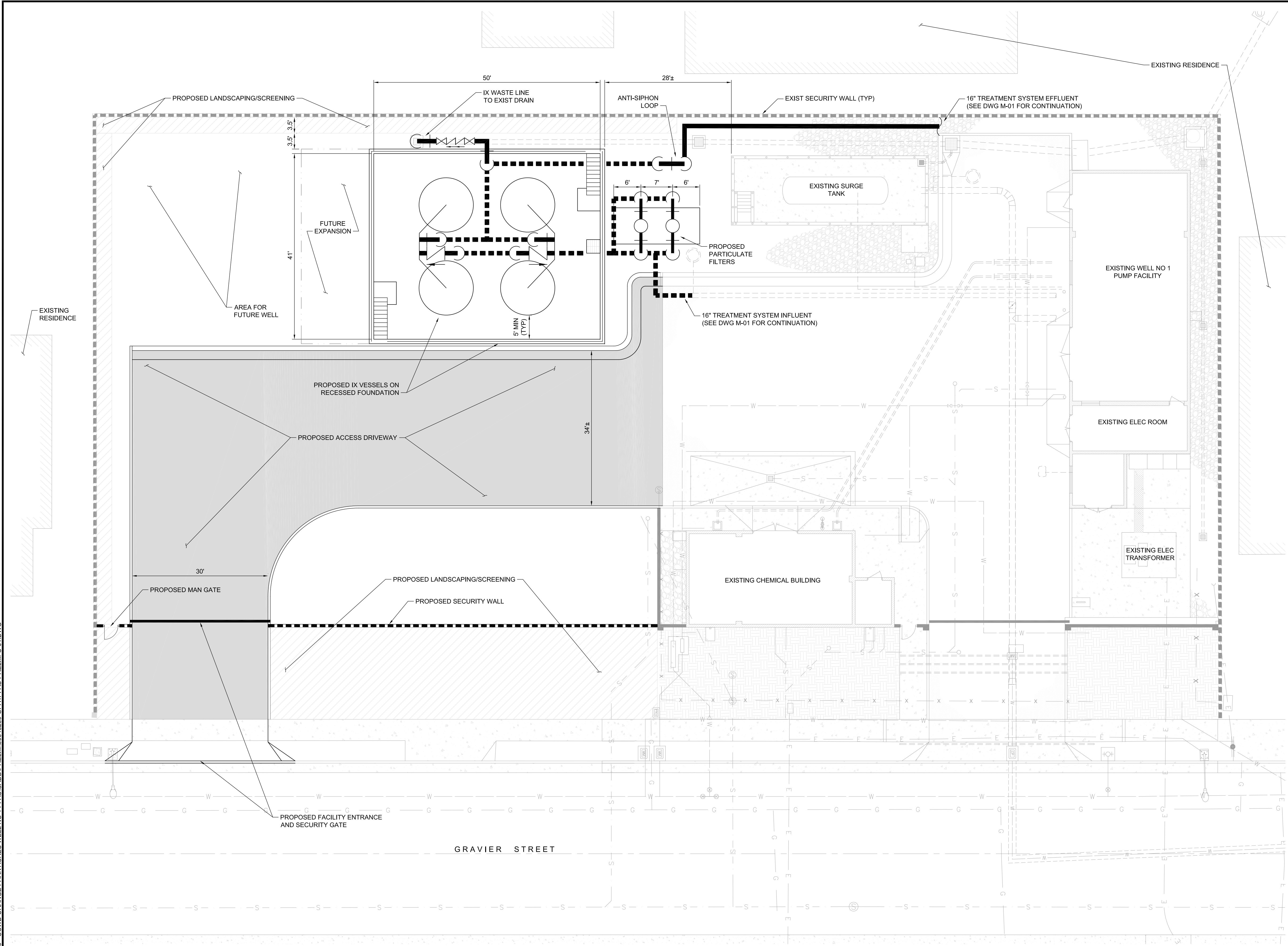
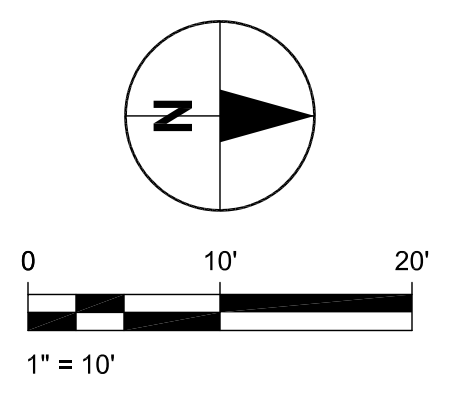

Last saved by: CONNELLY, J (2021-05-25) Last Plotted: 2021-05-25
 Filename: E:\PROJECTS\60649299 - COWD ORANGE PARK ACRES WELL NO. 1 PFAS\CAD\PRELIM\60649299-OPA1PFAS-PRELIM-C-01.DWG

NO.	DATE	REVISIONS	APPROVED

DESIGN:
 AECOM
 DRAWN:
 AECOM
 CHECK:
 AECOM

AECOM
 AECOM Technical Services, Inc
 999 Town & Country Road
 Orange, CA 92668
 714.567.4000 tel
 www.aecom.com

ENGINEER
 STAMP

NAME	<CONSULTANT> PROJECT ENGINEER R.C.E. XXXXX	DATE
NAME	<CONSULTANT> PROJECT MANAGER R.C.E. XXXXX	DATE
NAME	IRWD, PRINCIPAL ENGINEER R.C.E. XXXXX	DATE

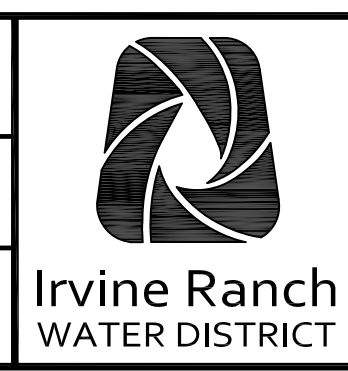

ORANGE PARK ACRES
 WELL NO 1 WELLHEAD FACILITIES
 PFAS TREATMENT SYSTEM
 PROJECT NO. XXXX

PROPOSED EQUIPMENT LAYOUT
 ALTERNATIVE 1

DRAWING
C-01
 3 OF 12
 SHEETS

OPA1 PFAS TREATMENT SYSTEM

CODE XXXX

MAY 2021

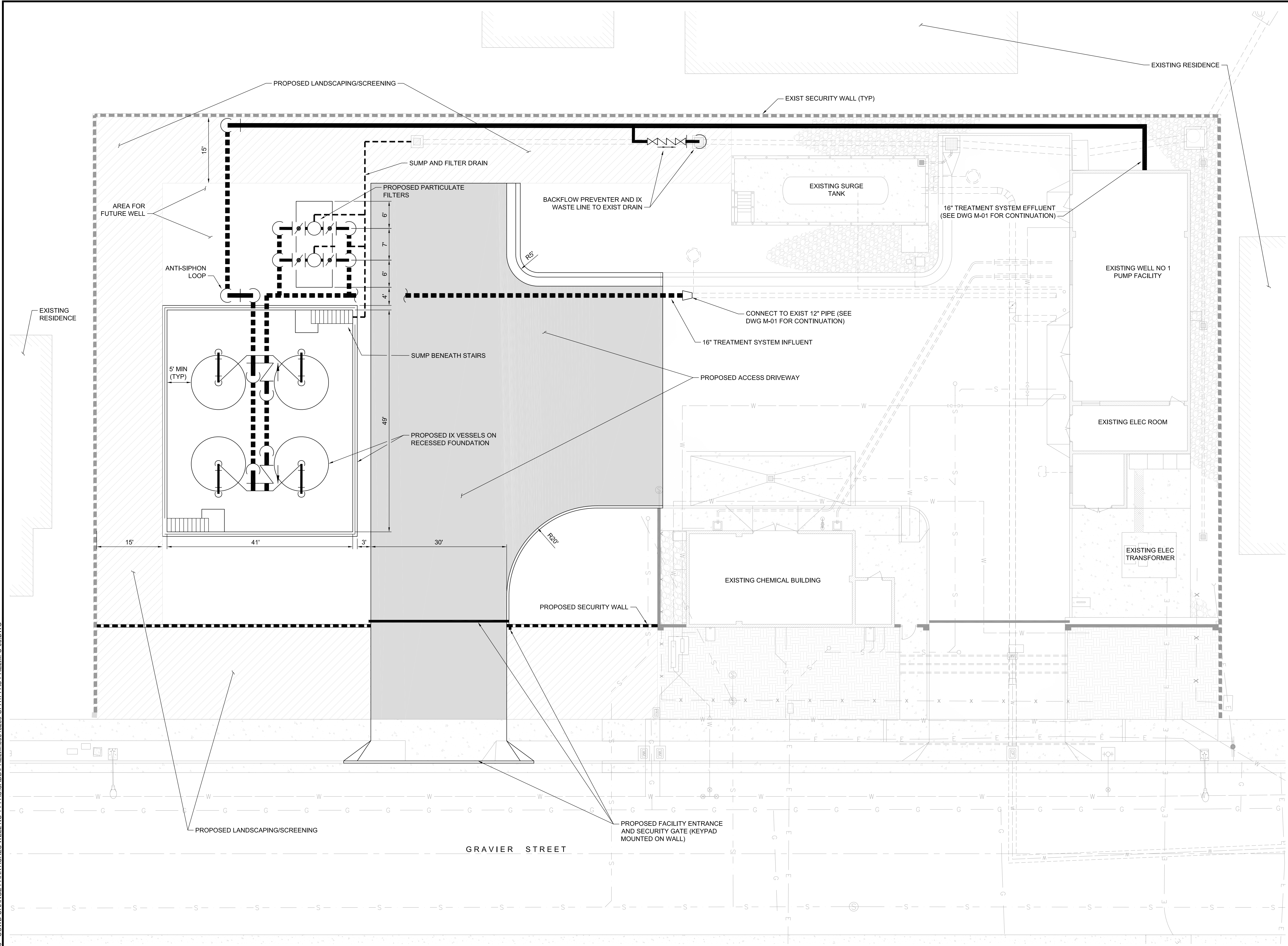
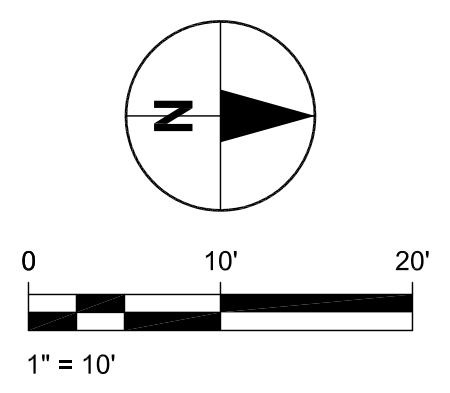

Last saved by: CONNELLY.J (2021-05-25) Last Plotted: 2021-05-25
 Filename: E:\PROJECTS\06049239 - COWD ORANGE PARK ACRES WELL NO. 1 PFAS\CAD\PRELIM\06049239-OPA1PFAS-PRELIM-C-06.DWG

OPA1 PFAS TREATMENT SYSTEM

CODE XXXX

NO.	DATE	REVISIONS	APPROVED

DESIGN:
 AECOM
 DRAWN:
 AECOM
 CHECK:
 AECOM

AECOM
 AECOM Technical Services, Inc
 999 Town & Country Road
 Orange, CA 92668
 714.567.4000 tel
 www.aecom.com

ENGINEER
 STAMP

NAME	<CONSULTANT> PROJECT ENGINEER R.C.E. XXXXX	DATE
NAME	<CONSULTANT> PROJECT MANAGER R.C.E. XXXXX	DATE
NAME	IRWD PRINCIPAL ENGINEER R.C.E. XXXXX	DATE

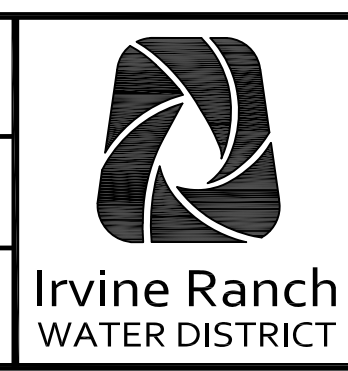

ORANGE PARK ACRES
 WELL NO 1 WELLHEAD FACILITIES
 PFAS TREATMENT SYSTEM

 PROJECT NO. XXXX

PROPOSED EQUIPMENT LAYOUT
 ALTERNATIVE 2

DRAWING
C-02
 4 OF 12
 SHEETS

MAY 2021

Last saved by: CONNELLY.J1(2021-05-25) Last Plotted: 2021-05-25
 Filename: E:\PROJECTS\60649299 - COWD ORANGE PARK ACRES WELL NO. 1\PFAS\CADD\PRELIM\0648255\OPA1PFAS-PRELIM-M-01.DWG

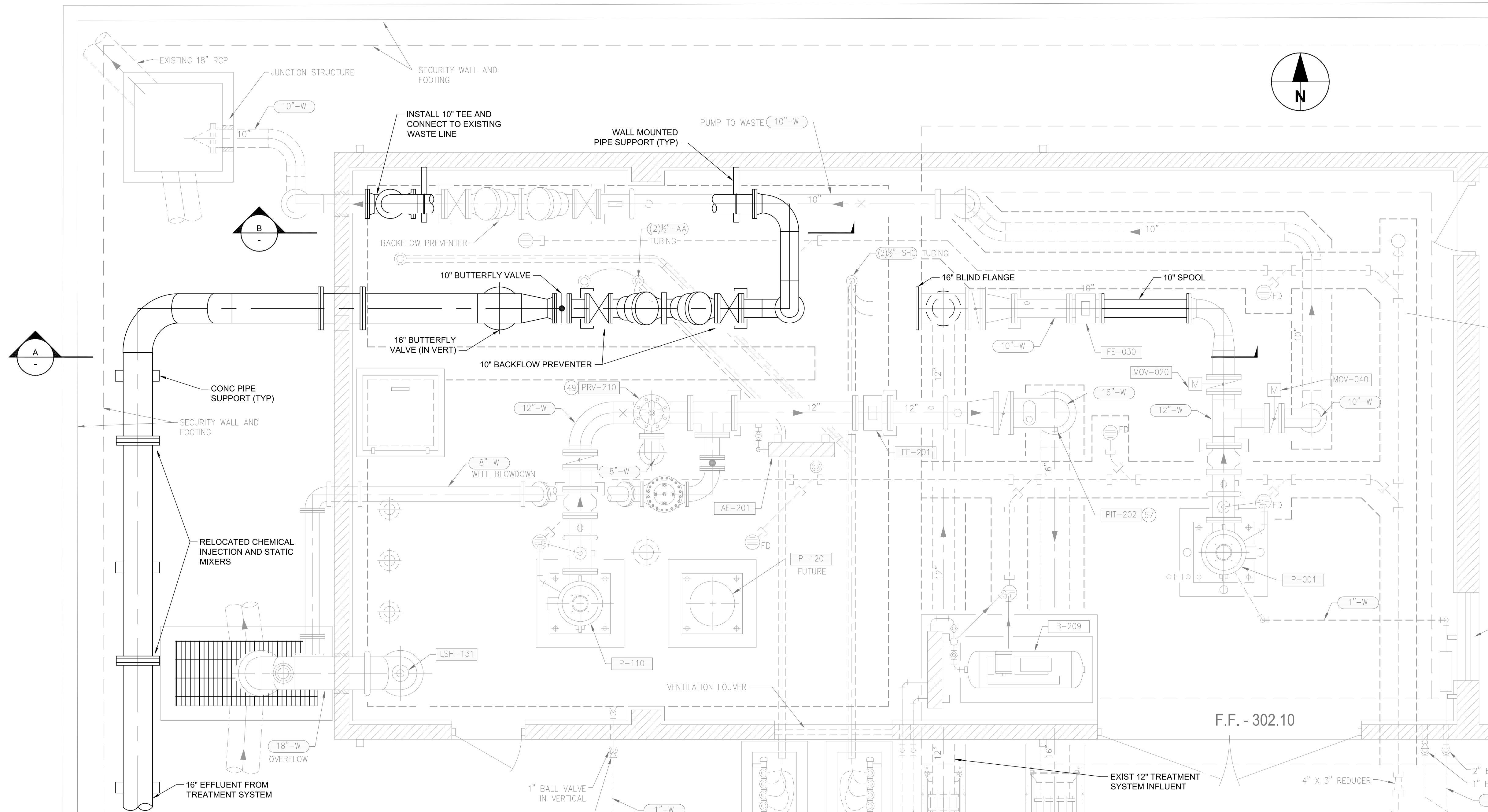

1 WELL NO 1 PUMPROOM PARTIAL PLAN
SCALE: 3/8" = 1'-0"

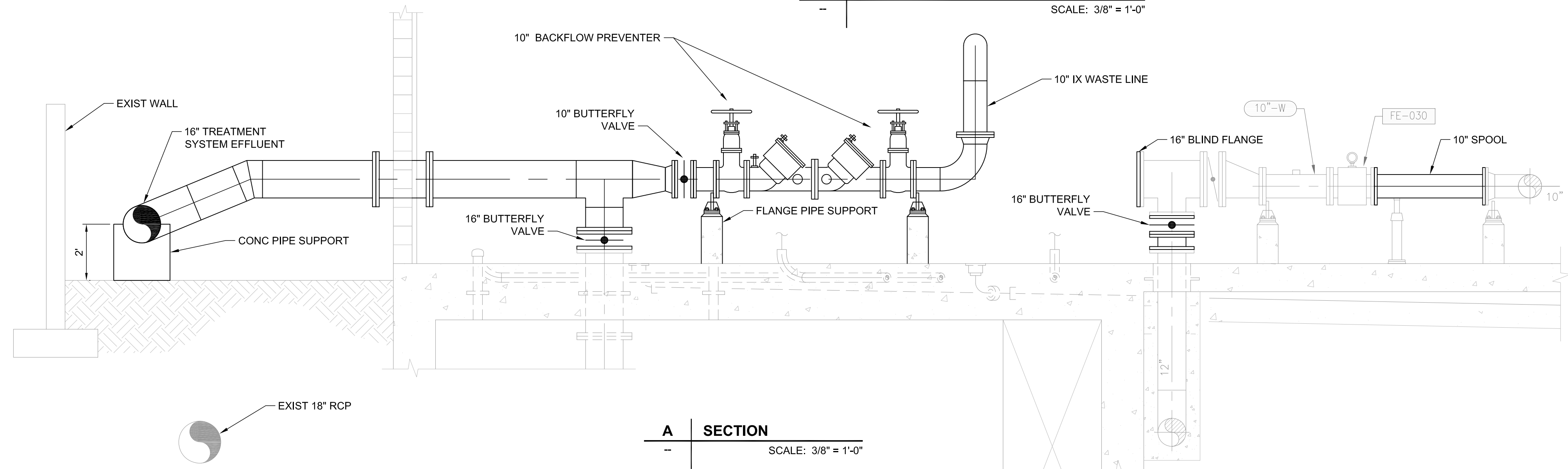

A SECTION
SCALE: 3/8" = 1'-0"

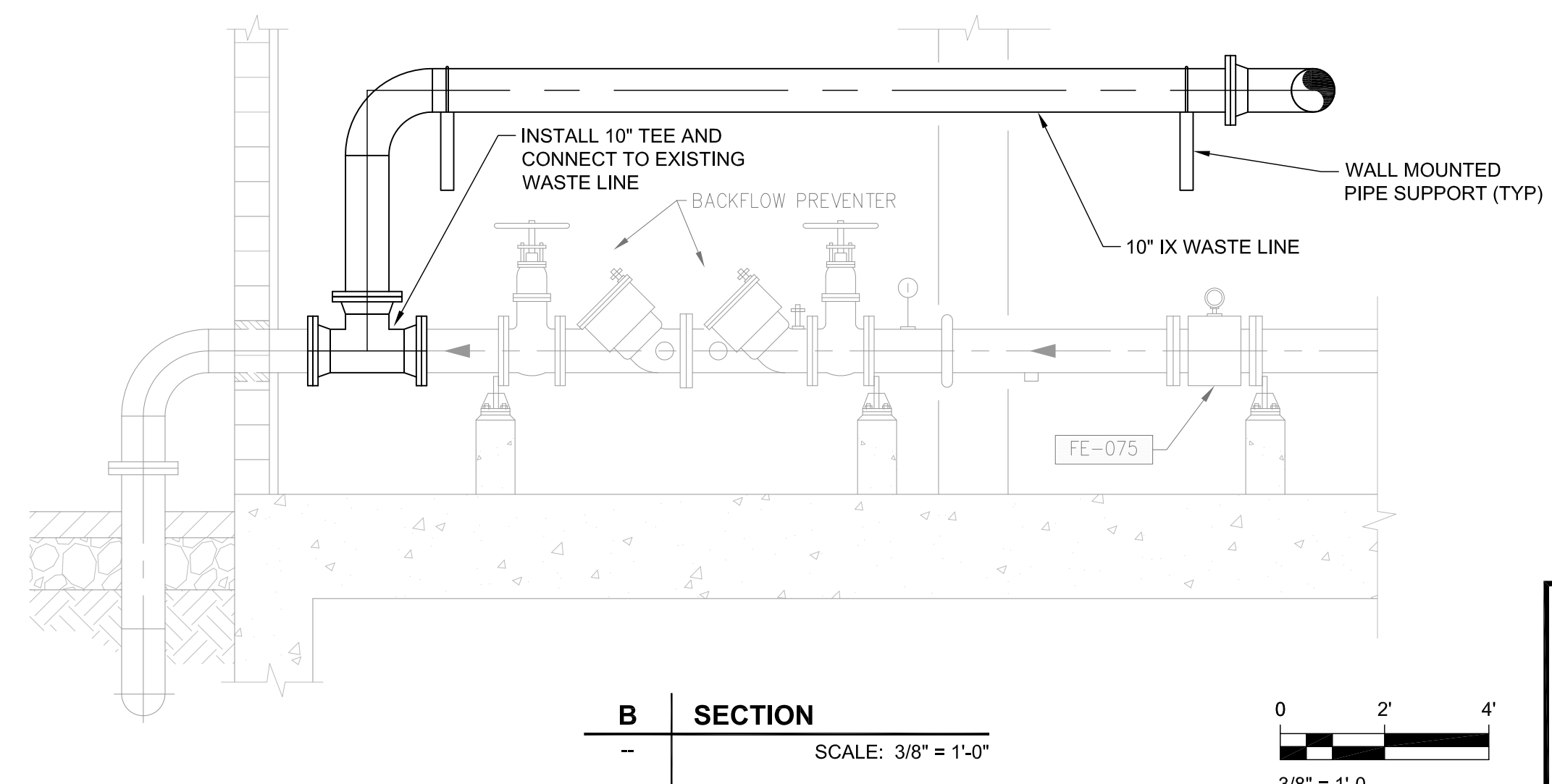

B SECTION
SCALE: 3/8" = 1'-0"

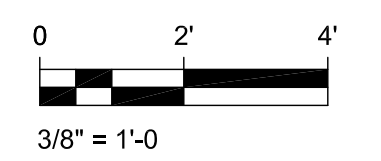

NO.	DATE	REVISIONS	APPROVED

DESIGN: AECOM
 DRAWN: AECOM
 CHECK: AECOM

AECOM

AECOM Technical Services, Inc
 999 Town & Country Road
 Orange, CA 92668
 714.567.4000 tel
 www.aecom.com

ENGINEER
STAMP

NAME	<CONSULTANT> PROJECT ENGINEER R.C.E. XXXXX	DATE
NAME	<CONSULTANT> PROJECT MANAGER R.C.E. XXXXX	DATE
NAME	IRWD, PRINCIPAL ENGINEER R.C.E. XXXXX	DATE

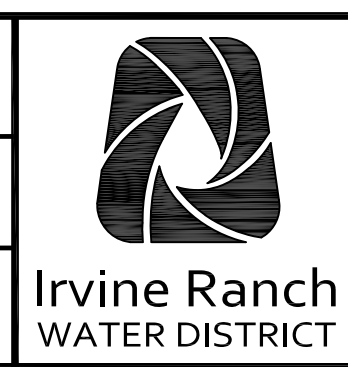

ORANGE PARK ACRES
WELL NO 1 WELLHEAD FACILITIES
PFAS TREATMENT SYSTEM

PROJECT NO. XXXX

PROPOSED PUMP ROOM
MODIFICATION PLAN AND SECTIONS
OPTION 1

DRAWING
M-01
5 OF 12
SHEETS

OPA1 PFAS TREATMENT SYSTEM

CODE XXXX

MAY 2021

Last saved by: CONNELLY.J1(2021-05-25) Last Plotted: 2021-05-25
 File name: E:\PROJECTS\06649239 - OCWD ORANGE PARK ACRES WELL NO. 1 PFAS\CADD\PRELIM\06649239-OPA1PFAS-PRELIM-M-06.DWG

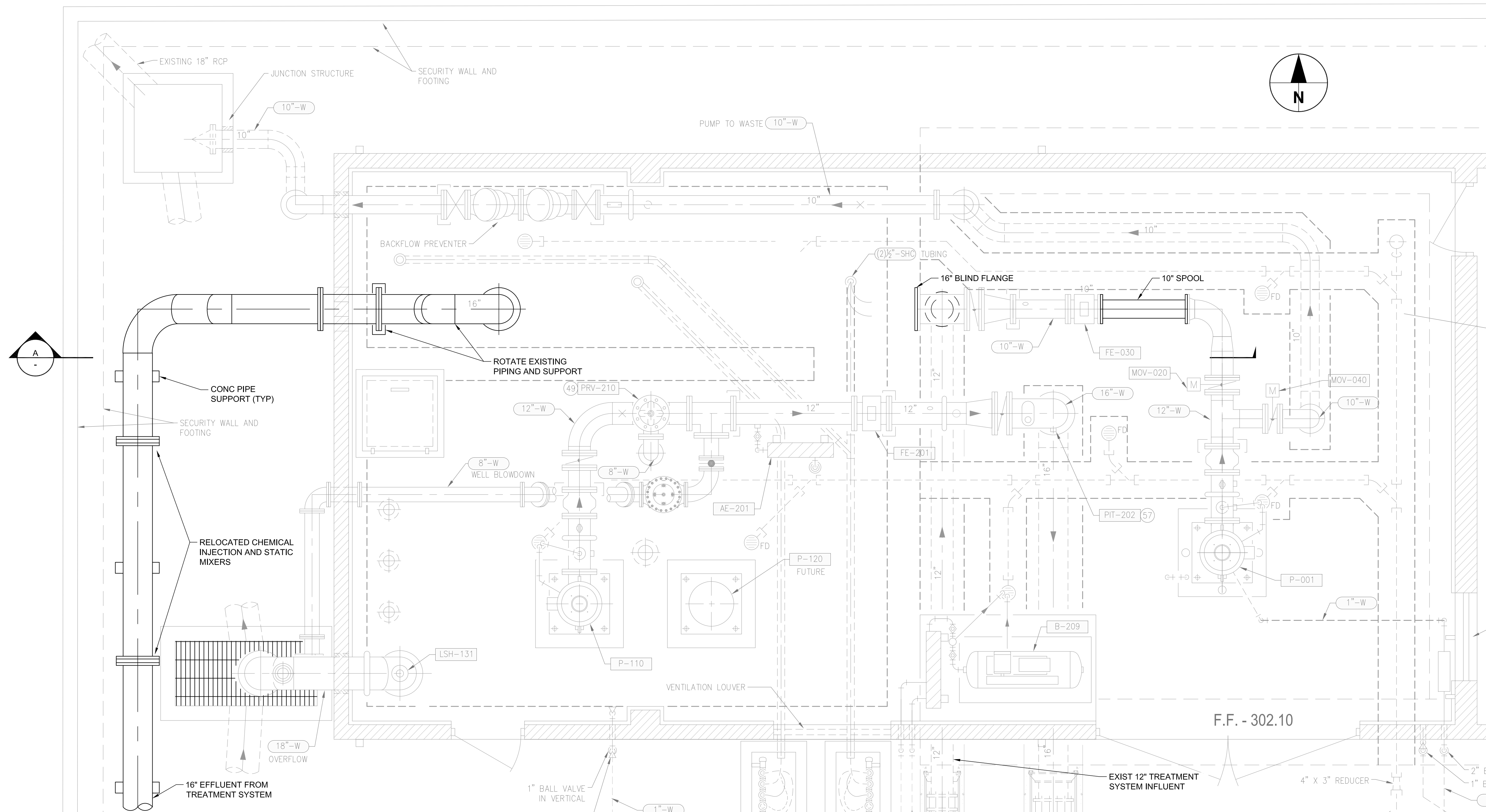

1 WELL NO 1 PUMPROOM PARTIAL PLAN
 SCALE: 3/8" = 1'-0"

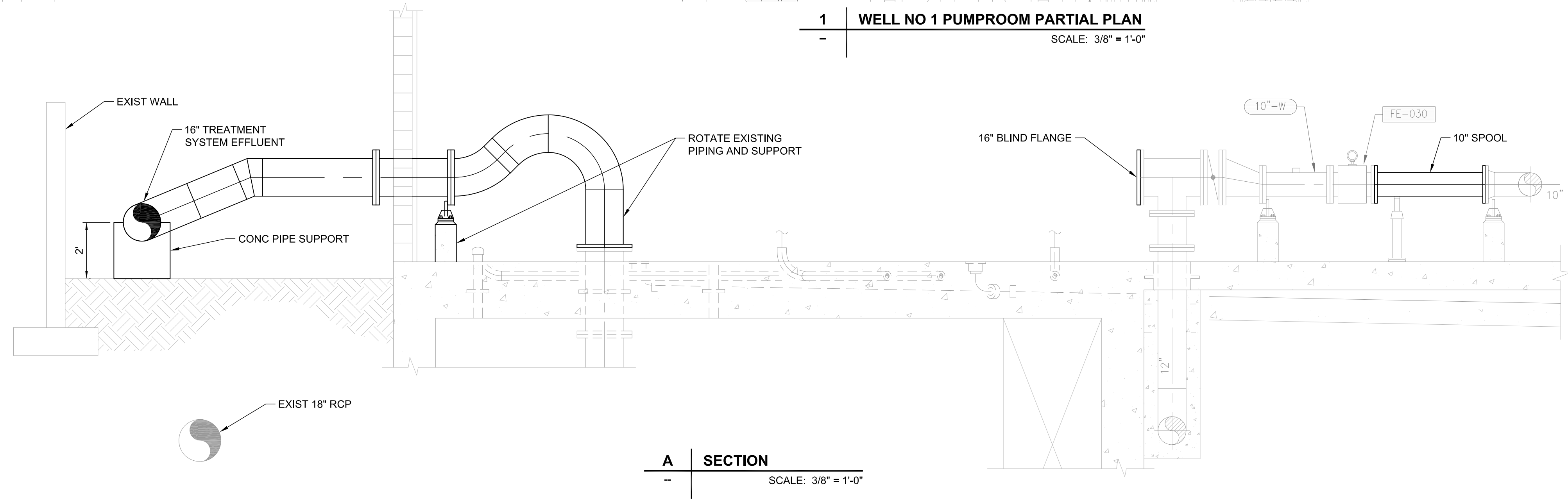

A SECTION
 SCALE: 3/8" = 1'-0"

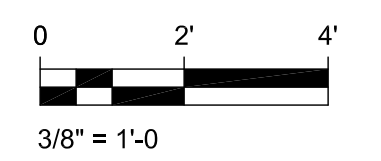

NO.	DATE	REVISIONS	APPROVED

DESIGN:
AECOM
 DRAWN:
AECOM
 CHECK:
AECOM

AECOM
 AECOM Technical Services, Inc
 999 Town & Country Road
 Orange, CA 92668
 714.567.4000 tel
 www.aecom.com

ENGINEER
STAMP

NAME	<CONSULTANT> PROJECT ENGINEER R.C.E. XXXXX	DATE
NAME	<CONSULTANT> PROJECT MANAGER R.C.E. XXXXX	DATE
NAME	IRWD, PRINCIPAL ENGINEER R.C.E. XXXXX	DATE

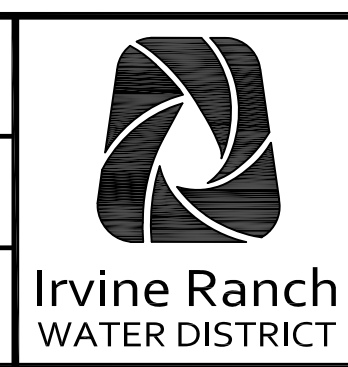

ORANGE PARK ACRES
WELL NO 1 WELLHEAD FACILITIES
PFAS TREATMENT SYSTEM

PROJECT NO. XXXX

PROPOSED PUMP ROOM
MODIFICATION PLAN AND SECTIONS
OPTION 2

DRAWING
M-02
 6 OF 12
SHEETS

OPA1 PFAS TREATMENT SYSTEM

CODE XXXX

MAY 2021

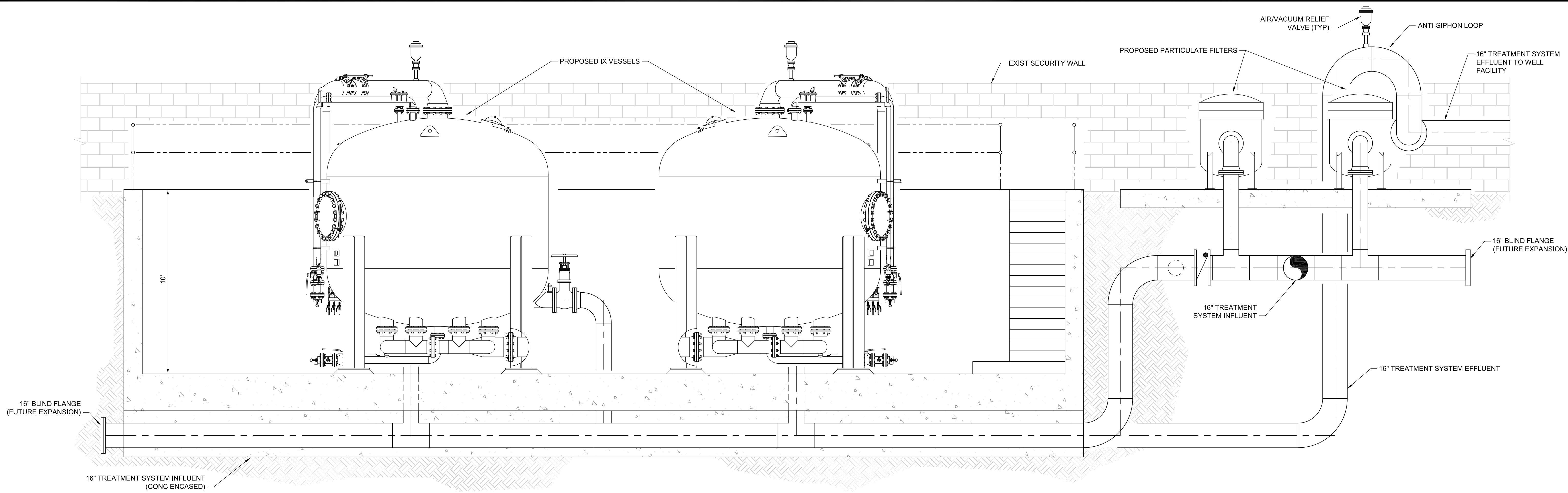

ELEVATION LOOKING WEST - ALTERNATIVE 1
SCALE: 3/8" = 1'-0"

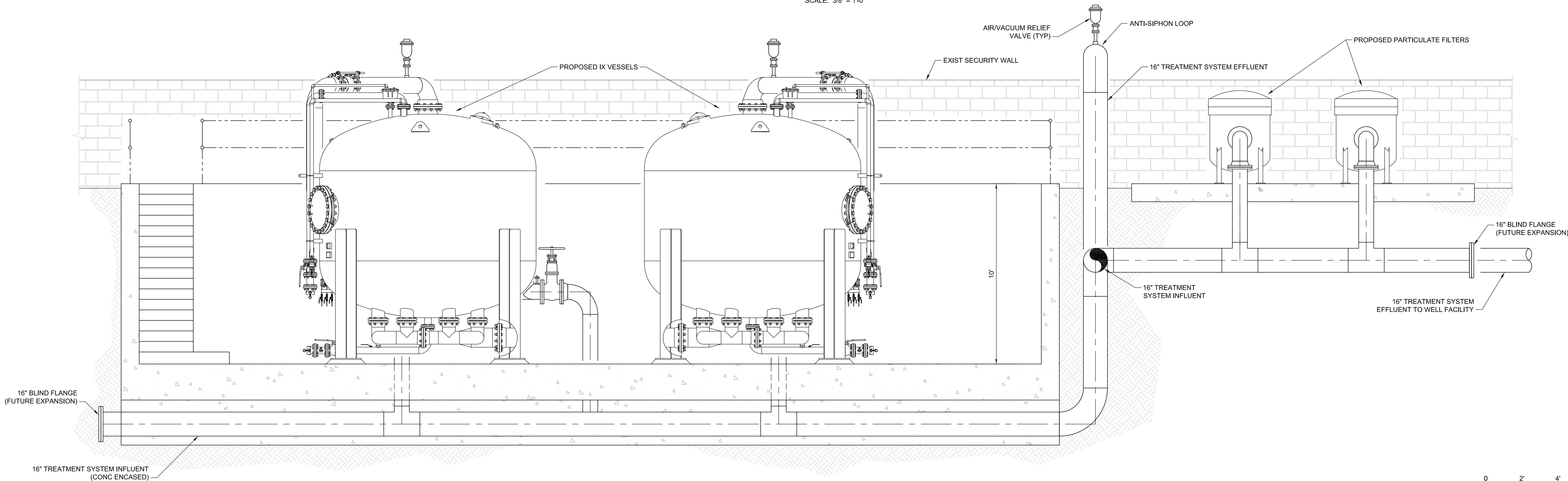

ELEVATION LOOKING SOUTH - ALTERNATIVE 2
SCALE: 3/8" = 1'-0"

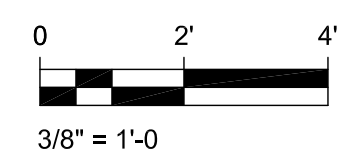

Last saved by: CONNELLY.J1(2021-05-25) Last Plotted: 2021-05-25
Filename: E:\PROJECTS\060649239 - OCWD ORANGE PARK ACRES WELL NO. 1 PFAS\CAD\IPRELIM\060649239-OPA1PFAS-PRELIM-M-201.DWG

NO.	DATE	REVISIONS	APPROVED

DESIGN:
AECOM
DRAWN:
AECOM
CHECK:
AECOM

AECOM
AECOM Technical Services, Inc
999 Town & Country Road
Orange, CA 92668
714.567.4000 tel
www.aecom.com

ENGINEER
STAMP

NAME	<CONSULTANT> PROJECT ENGINEER R.C.E. XXXXX	DATE
NAME	<CONSULTANT> PROJECT MANAGER R.C.E. XXXXX	DATE
NAME	IRWD PRINCIPAL ENGINEER R.C.E. XXXXX	DATE

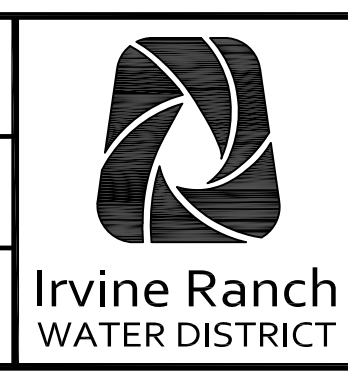

ORANGE PARK ACRES
WELL NO 1 WELLHEAD FACILITIES
PFAS TREATMENT SYSTEM

PROJECT NO. XXXX

IX TREATMENT ELEVATIONS -
ALTERNATIVES 1 & 2

DRAWING
M-201
7 OF 12
SHEETS

CODE XXXX
MAY 2021
OPA1 PFAS TREATMENT SYSTEM

REMOVE EXISTING SECTION WITH 250HP MOTOR STARTER AND REPLACE WITH NEW SECTION WITH 400HP MOTOR STARTER.
PULLBOX ABOVE MOTOR CONTROL CENTER

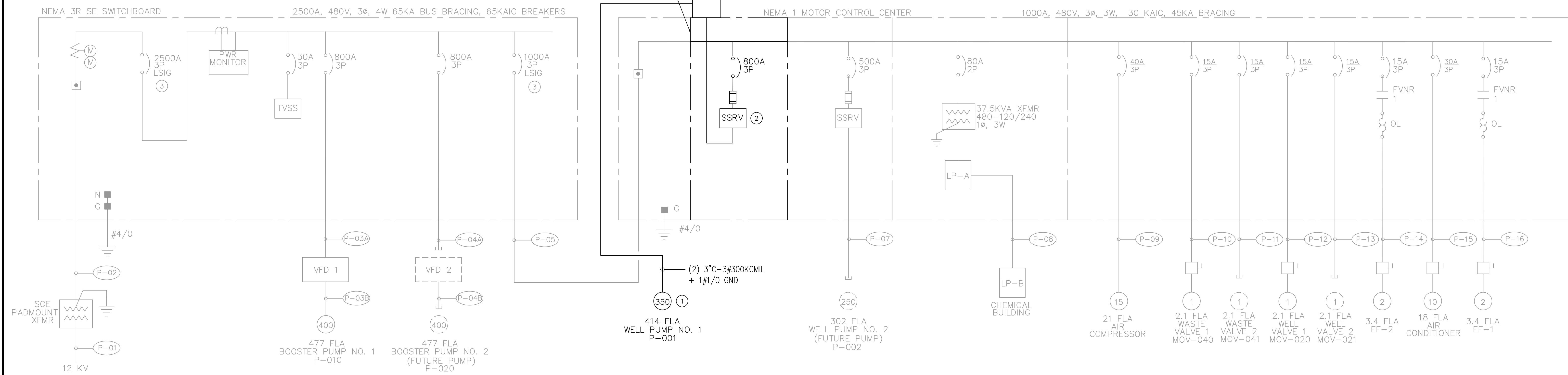

SERVICE ENTRANCE SWITCHBOARD 'SE' SINGLE LINE DIAGRAM
REFER TO CONTROL DIAGRAMS FOR CONTROL INFORMATION

MCC SINGLE LINE DIAGRAM
REFER TO CONTROL DIAGRAMS FOR CONTROL INFORMATION.

NOTES

- ① REPLACE EXISTING 250HP MOTOR WITH NEW 350HP MOTOR.
- ② REFER TO SHEETS E-04 AND E-05 FOR REVISIONS TO SOFT MOTOR STARTER.
- 3. LIGHT LINE WORK (——) DENOTES EXISTING EQUIPMENT.
DARK LINE WORK (——) DENOTES NEW EQUIPMENT.

SERVICE ENTRANCE SWITCHBOARD 'SE'					
LOAD	VOLTS	PHASE	CONNECTED		
			HP	KVA	AMPS
BOOSTER PUMP 1	480	3	400	477	-
BOOSTER PUMP 2	480	3	400	477	-
MCC	480	3	-	746.2	-
LCL 25% LARGEST MOTOR	480	3	-	120	-
TOTAL				1820.2	-

EXISTING MOTOR CONTROL CENTER 'MCC'					
LOAD	VOLTS	PHASE	CONNECTED		
			HP	KVA	AMPS
WELL PUMP 1	480	3	250	302	-
WELL PUMP 2	480	3	250	302	-
PANEL 'A'	480	3	-	12	-
AIR COMPRESSOR	480	3	-	21	-
WASTE VALVE 1	480	3	-	2.1	-
WASTE VALVE 2	480	3	-	2.1	-
WELL VALVE 1	480	3	-	2.1	-
WELL VALVE 2	480	3	-	2.1	-
EXHAUST FAN EF-1	480	3	-	3.4	-
EXHAUST FAN EF-2	480	3	-	3.4	-
AIR CONDITIONER	480	3	-	18	-
LCL 25% LARGEST MOTOR	480	3	-	76	-
TOTAL				746.2	-

REVISED MOTOR CONTROL CENTER 'MCC'					
LOAD	VOLTS	PHASE	CONNECTED		
			HP	KVA	AMPS
WELL PUMP 1	480	3	350	349	-
WELL PUMP 2	480	3	250	302	-
PANEL 'A'	480	3	-	12	-
AIR COMPRESSOR	480	3	-	21	-
WASTE VALVE 1	480	3	-	2.1	-
WASTE VALVE 2	480	3	-	2.1	-
WELL VALVE 1	480	3	-	2.1	-
WELL VALVE 2	480	3	-	2.1	-
EXHAUST FAN EF-1	480	3	-	3.4	-
EXHAUST FAN EF-2	480	3	-	3.4	-
AIR CONDITIONER	480	3	-	18	-
LCL 25% LARGEST MOTOR	480	3	-	87.25	-
TOTAL				804.45	968

Last saved by: DEKANE(2021-05-25) Last Plotted: 2021-05-25
Filename: E:\PROJECTS\06064929 - CDWD ORANGE PARK ACRES WELL NO. 1 PFAS\CAD\PRELIM\06064929\OPAFAS-PRELIM-E-01.DWG

NO.	DATE	REVISIONS	APPROVED

DESIGN: AECOM
DRAWN: AECOM
CHECK: AECOM



ENGINEER STAMP

NAME	<CONSULTANT> PROJECT ENGINEER	DATE
R.C.E.	XXXXX	
NAME	<CONSULTANT> PROJECT MANAGER	DATE
R.C.E.	XXXXX	
NAME	IRWD PRINCIPAL ENGINEER	DATE
R.C.E.	XXXXX	

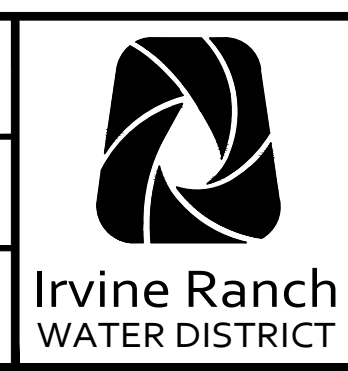

ORANGE PARK ACRES
WELL NO 1 WELLHEAD FACILITIES
PFAS TREATMENT SYSTEM

PROJECT NO. XXXX

SINGLE LINE DIAGRAM

DRAWING E-01
8 OF 12 SHEETS

OPAF1 PFAS TREATMENT SYSTEM

CODE XXXX

MAY 2021

Last saved by: DEKANE(2021-05-25) Last Plotted: 2021-05-25
 File name: E:\PROJECTS\0604929 - COWD ORANGE PARK ACRES WELL NO. 1\PFAS\CADD\PRELIM\0604929\0604929-OPAFAS-PRELIM-E-02.DWG

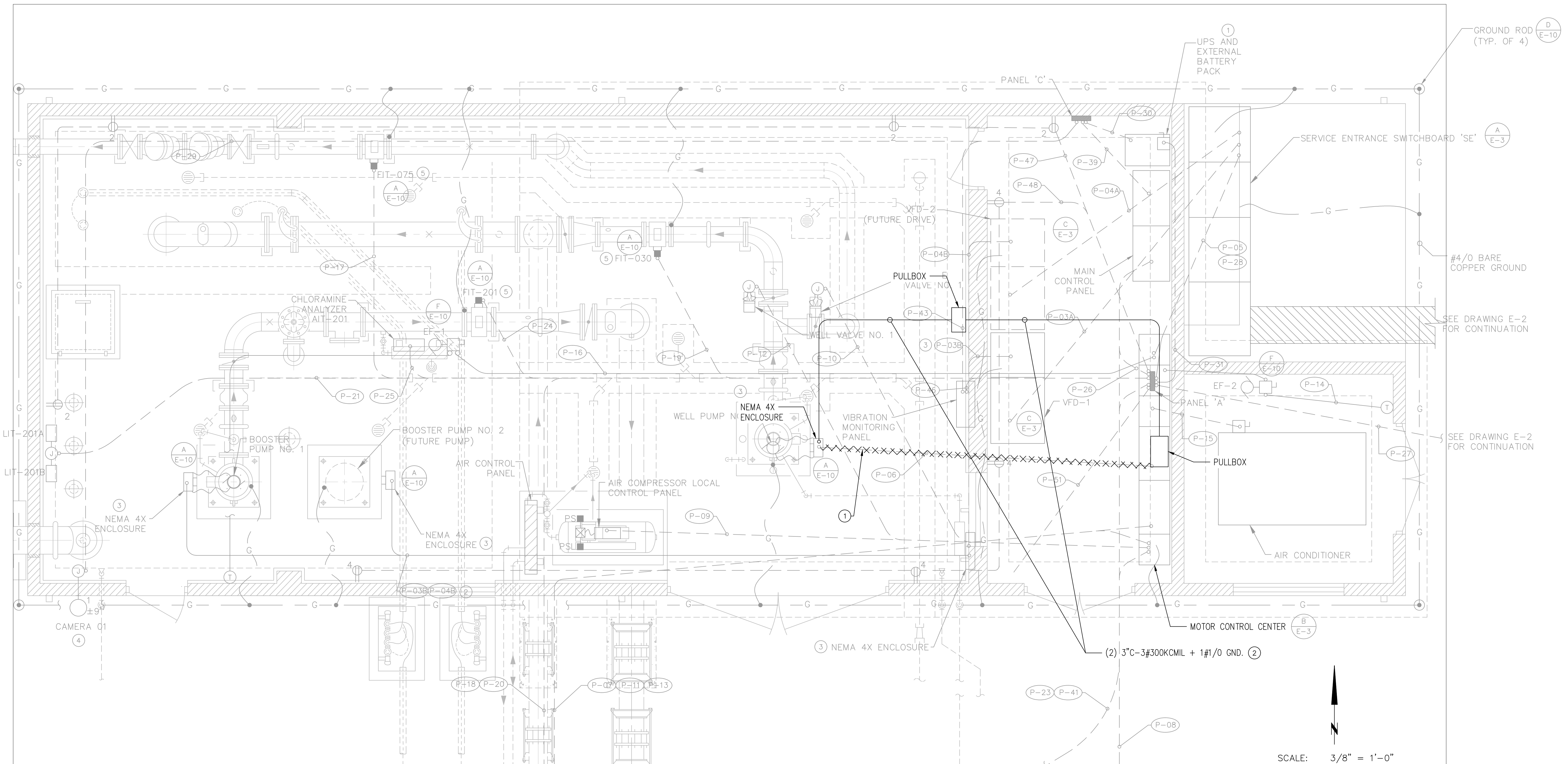

SEE DRAWING E-2 FOR CONTINUATION

SEE DRAWING E-2 FOR CONTINUATION

SEE DRAWING E-2 FOR CONTINUATION

SCALE: 3/8" = 1'-0"

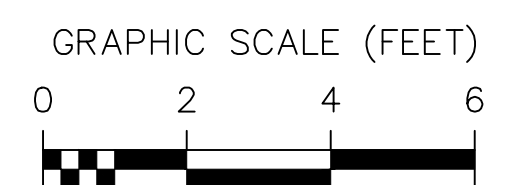

NOTES

- ① CUT EXISTING CONDUIT AT FLOOR LEVEL, PULL OUT EXISTING WIRE AND ABANDON CONDUIT IN PLACE.
- ② NEW CONDUIT SHALL BE EXPOSED.
- 3. LIGHT LINE WORK (——) DENOTES EXISTING EQUIPMENT.
 DARK LINE WORK (——) DENOTES NEW EQUIPMENT.

NO.	DATE	REVISIONS	APPROVED

DESIGN:
AECOM
DRAWN:
AECOM
CHECK:
AECOM

AECOM
 AECOM Technical Services, Inc
 999 Town & Country Road
 Orange, CA 92668
 714.567.400 tel
 www.aecom.com

ENGINEER
STAMP

NAME	<CONSULTANT> PROJECT ENGINEER R.C.E. XXXXX	DATE
NAME	<CONSULTANT> PROJECT MANAGER R.C.E. XXXXX	DATE
NAME	IRWD PRINCIPAL ENGINEER R.C.E. XXXXX	DATE

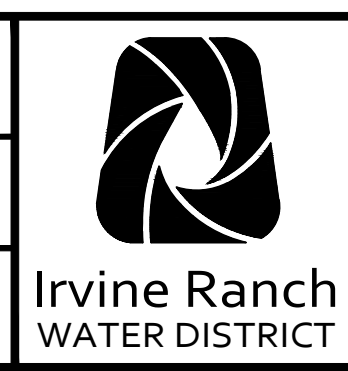

ORANGE PARK ACRES
 WELL NO 1 WELLHEAD FACILITIES
 PFAS TREATMENT SYSTEM

 PROJECT NO. XXXX

PUMP STATION POWER PLAN

DRAWING
E-02
9 OF 12 SHEETS

OPAF1 PFAS TREATMENT SYSTEM

CODE XXXX

MAY 2021

Last saved by: DEKANE(2021-05-25) Last Plotted: 2021-05-25
 Filename: E:\PROJECTS\60649259 - OCWD ORANGE PARK ACRES WELL NO. 1 PFAS\CADD\PRELIM\0649259-OPA1PFAS-PRELIM-E-03.DWG

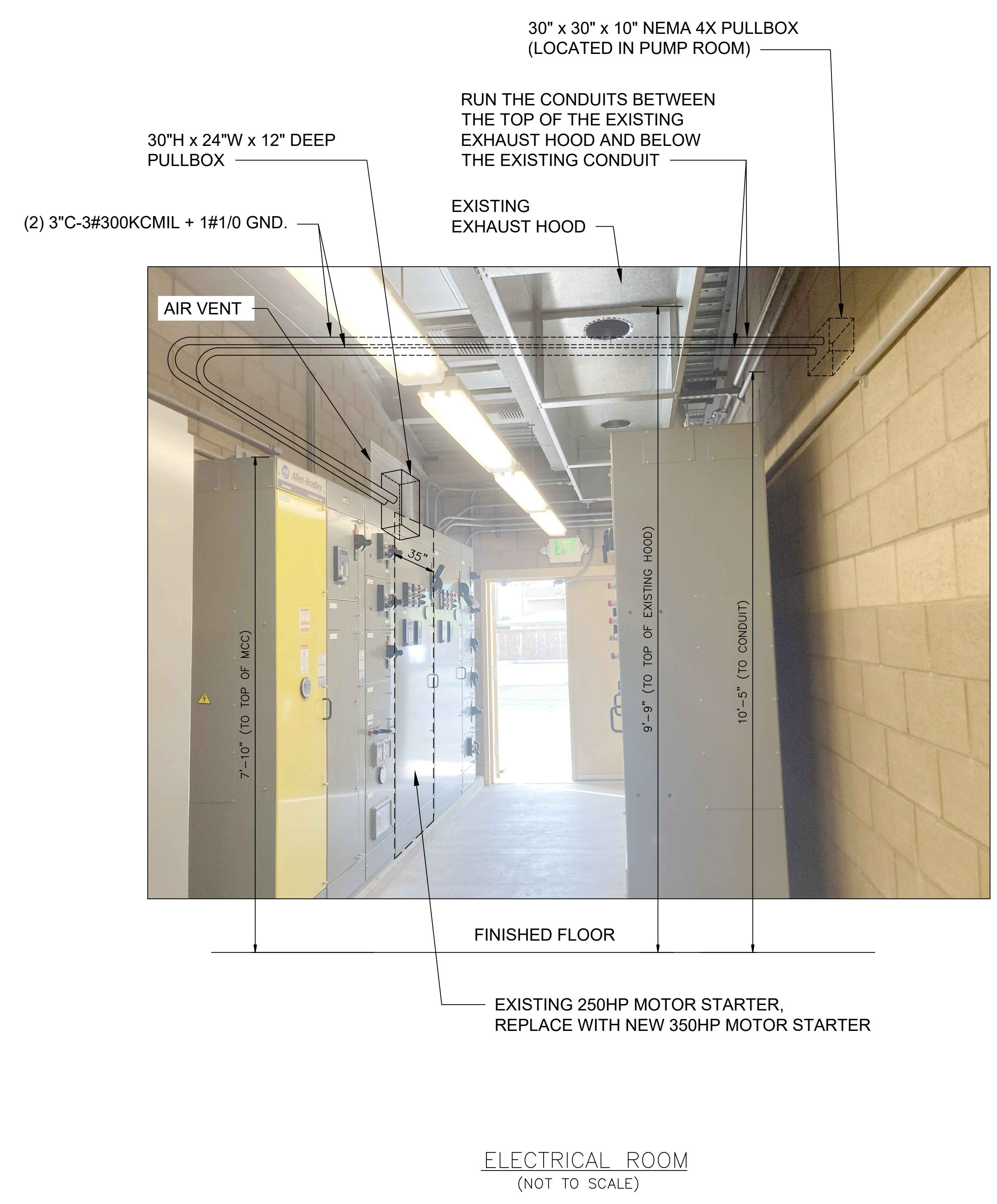

ELECTRICAL ROOM
(NOT TO SCALE)

NO.	DATE	REVISIONS	APPROVED

DESIGN:
AECOM
DRAWN:
AECOM
CHECK:
AECOM

AECOM
 AECOM Technical Services, Inc
 999 Town & Country Road
 Orange, CA 92668
 714.567.4000 tel
 www.aecom.com

ENGINEER
STAMP

NAME	<CONSULTANT> PROJECT ENGINEER R.C.E. XXXXX	DATE
NAME	<CONSULTANT> PROJECT MANAGER R.C.E. XXXXX	DATE
NAME	IRWD, PRINCIPAL ENGINEER R.C.E. XXXXX	DATE

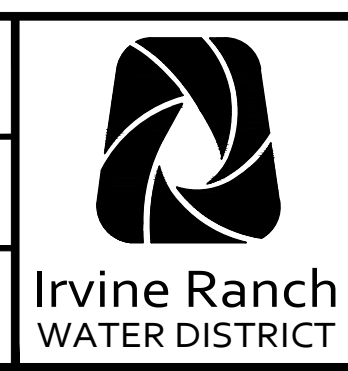

ORANGE PARK ACRES
WELL NO 1 WELLHEAD FACILITIES
PFAS TREATMENT SYSTEM

PROJECT NO. XXXX

ELECTRICAL ROOM

DRAWING
E-03
10 OF 12
SHEETS

CODE XXXX

OPA1 PFAS TREATMENT SYSTEM

MAY 2021

- NOTES**
1. REMOTE DEVICE
 2. BULLETIN 150 SOLID STATE MOTOR CONTROLLER. REFER TO SMC USER MANUAL FOR APPLICATION DATA.
 3. PROGRAM LOGIC MASK (PARAMETER 87) TO MASK CODE "44".
 4. FOR SET-UP OF PUMP CONTROL FEATURE, REFER TO SMC FLEX USER MANUAL.
 5. FOR ETHERNET/IP ORDERS, ETHERNET CABLE CONNECTED TO MAG IN VVVV OR TO SWITCH IN HWVY FOR FRAME MOUNT UNITS. FOR ALL OTHER ORDERS, NO CONNECTION IS MADE.
- CIRCUIT BREAKER DEVICES**
- INT INTERNAL CIRCUIT BREAKER DEVICES SUPPLIED WITH UNMOUNTED CONNECTION BLOCKS.

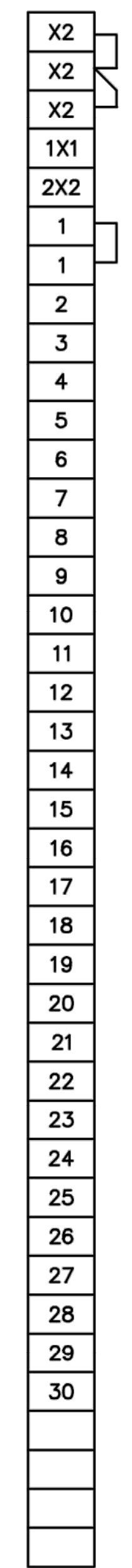
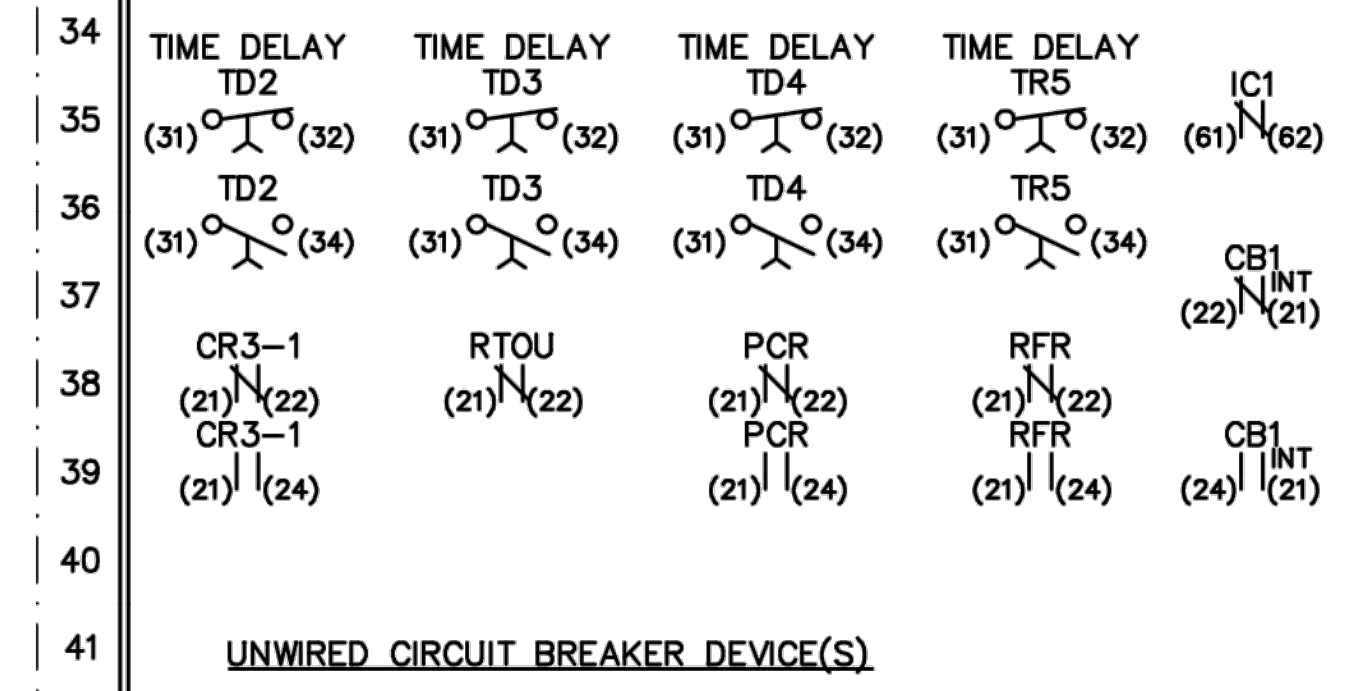
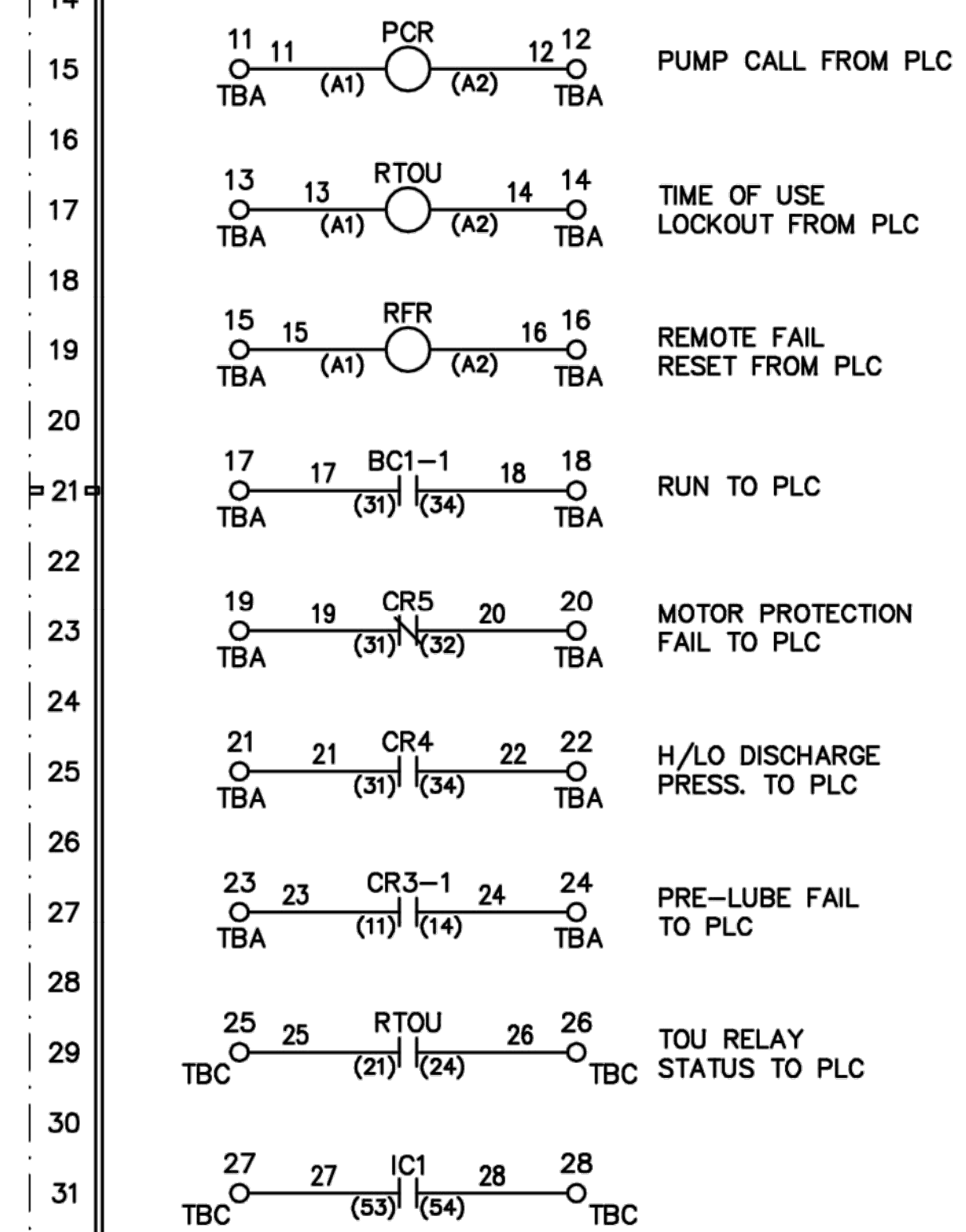

- NOTES**
1. EXISTING CONTROL WIRES FROM FIELD DEVICES SHALL BE RECONNECTED TO NEW MOTOR STARTER.
 2. EXISTING CONTROL WIRES FROM AND TO PLC SHALL BE RECONNECTED TO NEW MOTOR STARTER.

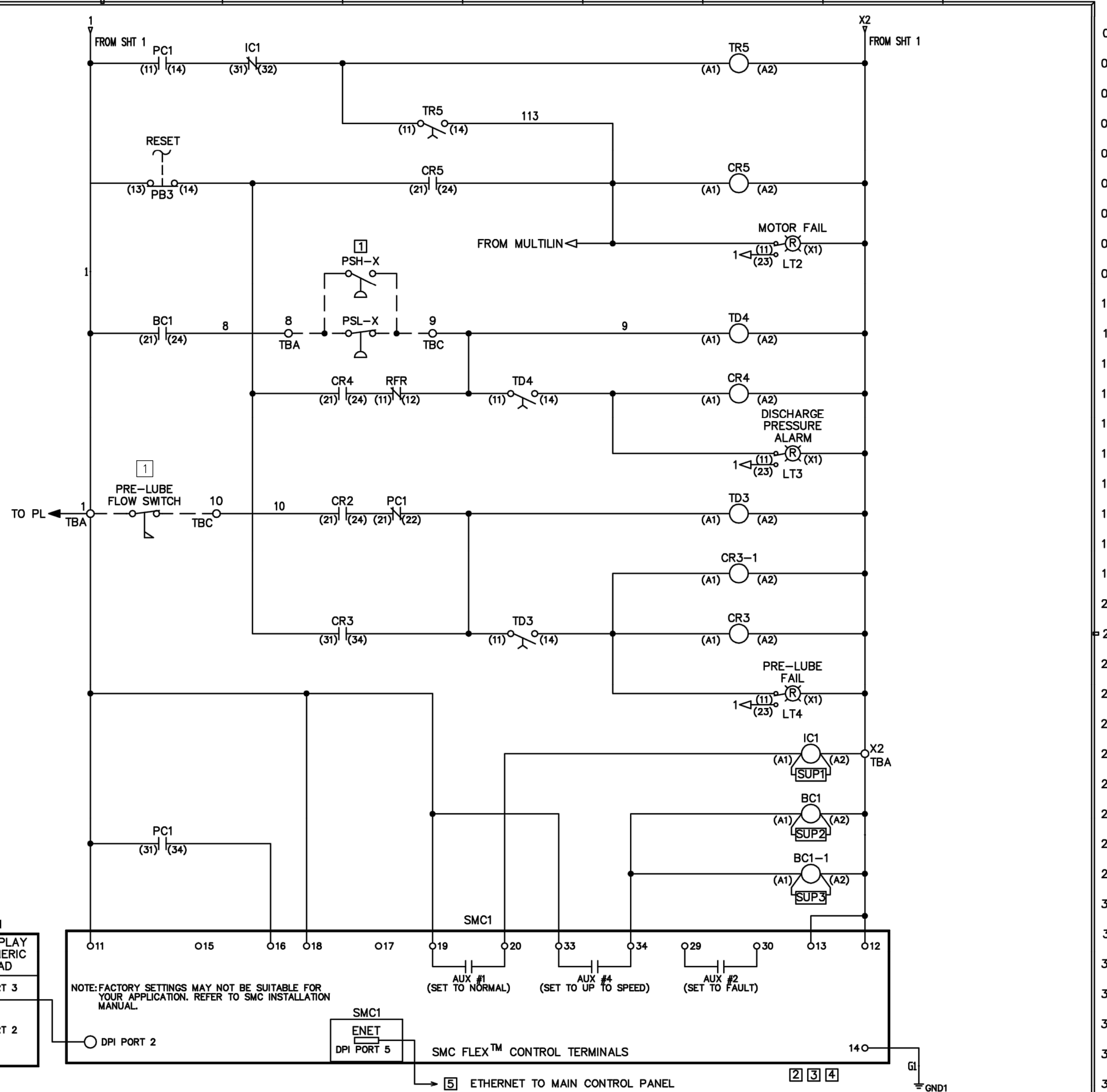

REV	APPROVED	DATE	STAGE	ECN/CR NO	PROJECT:		CONFIDENTIAL AND PROPRIETARY INFORMATION. THIS DOCUMENT CONTAINS CONFIDENTIAL AND PROPRIETARY INFORMATION OF ROCKWELL AUTOMATION, INC. AND MAY NOT BE USED, COPIED OR DISCLOSED TO OTHERS EXCEPT WITH THE AUTHORIZED WRITTEN PERMISSION OF ROCKWELL AUTOMATION INC.	
					IRWD - ORANGE PARK ACRES WELL NO.1			
					CUSTOMER: QNESOURCE DISTRIBUTORS INC 0099141666 S4204511			
					ORDER-LINE NUMBER: 6501662539-000100			
BASE DOC. NUMBER:					LANG.:ENG	PROJ. DOC. TYPE: ELECTRICAL SCHEMATIC	DRAWN BY: O. ARTEAGA	DATE: 13-MAY-14
						2155J 317 AMP SMC-FLEX	SHEET 2 OF 2	
							SIZE D 10000951136 00	

Last saved by: CONNELLY.J1(2021-05-25) File name: E:\PROJECTS\060649299 - COWD ORANGE PARK ACRES WELL NO. 1\PFAS\CADD\PRELIM\060649299-06A\PFAS-PRELIM-E-05.DWG

NO.	DATE	REVISIONS	APPROVED	DESIGN:
				AECOM
				AECOM
				AECOM

DESIGN: AECOM
DRAWN: AECOM
CHECK: AECOM

AECOM Technical Services, Inc
999 Town & Country Road
Orange, CA 92668
714.567.4000 tel
www.aecom.com

ENGINEER STAMP

NAME	<CONSULTANT> PROJECT ENGINEER	DATE
NAME	<CONSULTANT> PROJECT MANAGER	DATE
NAME	IRWD, PRINCIPAL ENGINEER	DATE

Irvine Ranch WATER DISTRICT

ORANGE PARK ACRES WELL NO 1 WELLHEAD FACILITIES PFAS TREATMENT SYSTEM

PROJECT NO. XXXX

SCHEMATIC DIAGRAM (NEW 400HP SOLID STATE MOTOR STARTER) (SHEET 2 OF 2)

DRAWING E-05
12 OF 12 SHEETS

OP#1 PFAS TREATMENT SYSTEM

CODE XXXX

MAY 2021

Appendix A: Site Survey

SCALE: 1"=10'

LEGEND

- NG NATURAL GROUND
- FS FINISHED SURFACE
- TC TOP OF CURB
- FL FLOW LINE
- EG EDGE OF GUTTER
- EP EDGE OF PAVEMENT
- ICV IRRIGATION CONTROL
- PP POWER POLE
- WM WATER METER
- GB GRADE BREAK
- LP LIGHT POLE
- HH HAND HOLE
- BW BACK WALK
- WV WATER VALVE
- TG TOP GRATE
- SDMH STORM DRAIN MANHOLE
- COM COMMUNICATION
- VLT VAULT
- XFMR TRANSFORMER
- BOL BOLLARD
- FDC FIRE DEPARTMENT CONNECTION
- UTL UTILITY BOX
- ELECT ELECTRIC
- BCFP BACKFLOW PREVENTOR
- FENCE
- WALL (WIDTHS VARY)
- ⊕ GAS METER

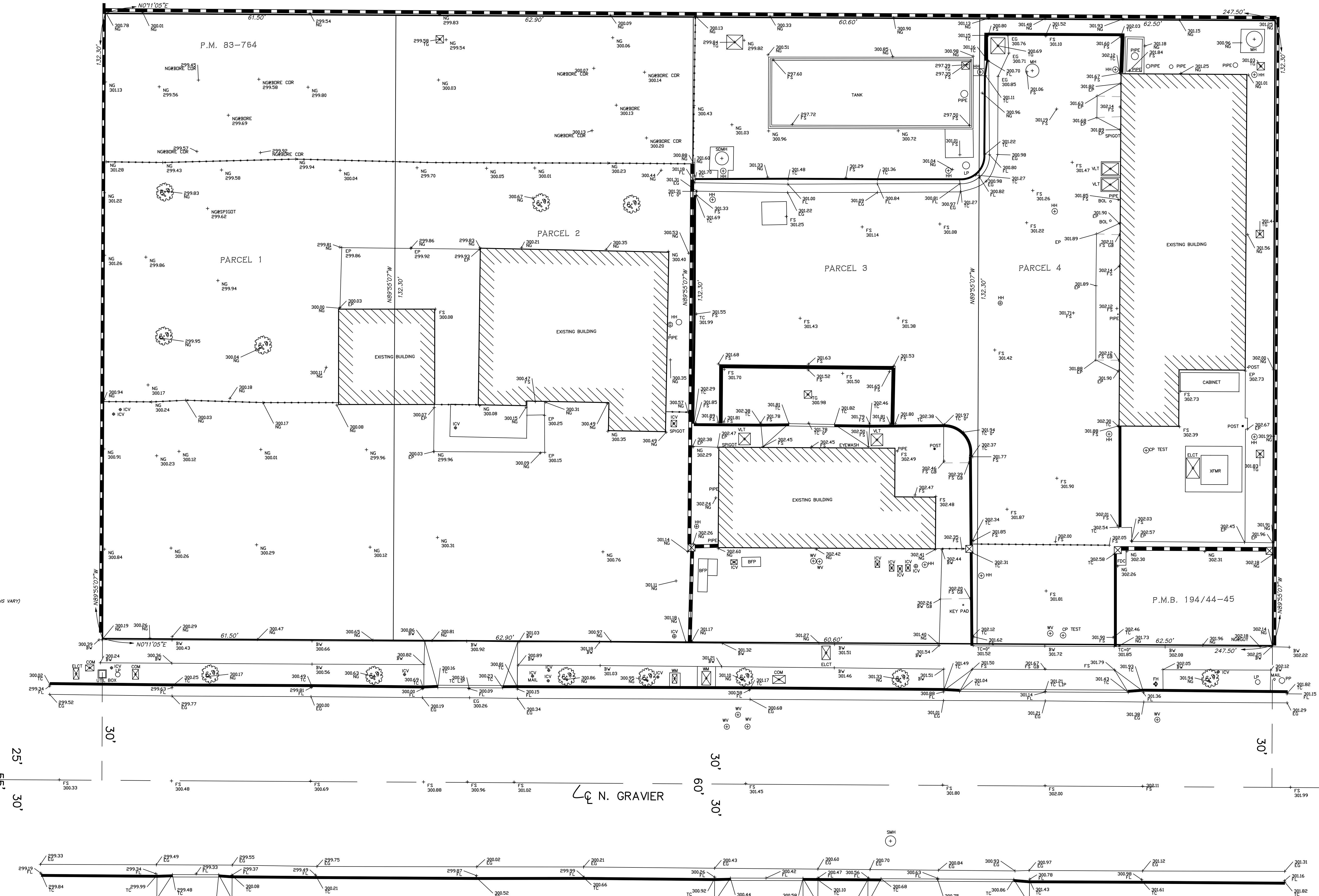

LEGAL DESCRIPTION:
 PARCEL MAP NO. 83-764, IN THE CITY OF ORANGE,
 COUNTY OF ORANGE, STATE OF CALIFORNIA, AS
 PER MAP RECORDED IN BOOK 194, PAGES 44 AND
 45 OF PARCEL MAPS, RECORDS OF ORANGE
 COUNTY, CALIFORNIA.

ASSESSORS PARCEL NO.:
 APN# 383-294-02

BASIS OF BEARINGS:
 THE BEARINGS SHOWN HEREON ARE
 BASED UPON THE BEARING BETWEEN
 O.C.S. HORIZONTAL CONTROL STATION
 OPS NO. 3169 AND STATION NO. 3168R1
 BEING NORTH 88°57'20" WEST PER
 RECORDS ON FILE IN THE OFFICE OF
 THE ORANGE COUNTY SURVEYOR.

SURVEYORS NOTES:
 THIS IS A TOPOGRAPHIC MAP AND NOT A BOUNDARY SURVEY! BOUNDARY
 INFORMATION SHOWN HEREON IS RECORD DATA AS SHOWN ON PARCEL MAP NO.
 83-764, AS PER MAP RECORDED IN BOOK 194, PAGES 44 AND 45 OF PARCEL
 MAPS, RECORDS OF ORANGE COUNTY, CALIFORNIA.
 THIS SURVEY DOES NOT PURPORT TO DISCLOSE EASEMENTS EXCEPT THOSE
 SPECIFICALLY DELINEATED HEREON, IF ANY. IF UNDERGROUND UTILITIES, OTHER
 STRUCTURES OR ZONES, SETBACK AND STREET WIDENING DATA ARE SHOWN
 HEREON, IT IS FOR INFORMATION ONLY, HAVING BEEN OBTAINED FROM OTHERS
 SOURCES NOT CONNECTED WITH THIS COMPANY. NO REPRESENTATION IS MADE AS
 TO THE ACCURACY OR COMPLETENESS OF SAID INFORMATION AND ANY USER OF
 THIS MAP IS URGED TO CONTACT THE UTILITY OR GOVERNING AGENCY DIRECTLY.

BENCHMARK:
 ELEVATIONS SHOWN ARE BASED UPON ORANGE COUNTY PUBLIC WORKS MONUMENT NO. 3A-92-71,
 ELEVATION = 327.116' (NAVD88)
 COORDINATES SHOWN ARE BASED ON THE CALIFORNIA COORDINATE SYSTEM (CCS83), ZONE VI, 1983
 NAD, 2007.00 EPOCH OCS GPS ADJUSTMENT.
 DESCRIPTION:
 STAMPED "3A-92-71", SET IN THE TOP OF A 6 IN. BY 6 IN. CONCRETE POST. MONUMENT IS LOCATED
 IN THE SOUTHEASTERLY CORNER OF THE INTERSECTION OF RANCHO SANTIAGO BLVD. AND BOND AVE.,
 51 FT. EASTERLY OF THE CENTERLINE OF RANCHO SANTIAGO AND 53 FT. SOUTHERLY OF THE
 CENTERLINE PROLONGATION OF BOND TO THE WEST. MONUMENT IS SET LEVEL WITH THE SIDEWALK.



BORCHARD SURVEYING AND MAPPING, INC.
 815 CALLE PUENTE
 SAN CLEMENTE CA. 92672
 (949)439-4682

TOPOGRAPHIC SURVEY OF:
 678 N. GRAVIER ST.
 ORANGE, CA 92869
 DATE OF SURVEY: 02/16/21

SHEET
 1
OF
 1

Appendix B: Utility Research

UNDERGROUND UTILITY MAP

WITHIN THE CITY OF ORANGE, COUNTY OF ORANGE, CALIFORNIA

PREPARED FOR:

AECOM

NOTE:
BACKGROUND IMAGE IS FROM GOOGLE
EARTH AND IS FOR REFERENCE ONLY.

**NO BACKGROUND HAS BEEN PROVIDED
BY CLIENT. ONCE BACKGROUND IS
PROVIDED UTILITY MAP WILL BE UPDATED**

UTILITY QUALITY LEVELS NOTES

INFORMATION PROVIDED FROM AMERICAN SOCIETY OF CIVIL ENGINEERS (ASCE) CI/ASCE 38-02 MANUAL.

UTILITY QUALITY LEVEL A

PRECISE HORIZONTAL AND VERTICAL LOCATION OF UTILITIES OBTAINED BY THE ACTUAL EXPOSURE (OR VERIFICATION OF PREVIOUSLY EXPOSED AND SURVEYED UTILITIES) AND SUBSEQUENT MEASUREMENT OF SUBSURFACE UTILITIES, USUALLY AT A SPECIFIC POINT. MINIMALLY INTRUSIVE EXCAVATION EQUIPMENT IS TYPICALLY USED TO MINIMIZE THE POTENTIAL FOR UTILITY DAMAGE. A PRECISE HORIZONTAL AND VERTICAL LOCATION, AS WELL AS OTHER UTILITY ATTRIBUTES, IS SHOWN ON PLAN DOCUMENTS. ACCURACY IS TYPICALLY SET TO 15-MM VERTICAL AND TO APPLICABLE HORIZONTAL SURVEY AND MAPPING ACCURACY AS DEFINED OR EXPECTED BY THE PROJECT OWNER.

UTILITY QUALITY LEVEL B

INFORMATION OBTAINED THROUGH THE APPLICATION OF APPROPRIATE SURFACE GEOPHYSICAL METHODS TO DETERMINE THE EXISTENCE AND APPROXIMATE HORIZONTAL POSITION OF SUBSURFACE UTILITIES. QUALITY LEVEL B DATA SHOULD BE REPRODUCIBLE BY SURFACE GEOPHYSICS AT ANY POINT OF THEIR DEPICTION. THIS INFORMATION IS SURVEYED TO APPLICABLE TOLERANCES DEFINED BY THE PROJECT AND REDUCED ONTO PLAN DOCUMENTS.

UTILITY QUALITY LEVEL C

INFORMATION OBTAINED BY SURVEYING AND PLOTTING VISIBLE ABOVE-GROUND UTILITY FEATURES AND BY USING PROFESSIONAL JUDGMENT IN CORRELATING THIS INFORMATION TO QUALITY LEVEL D INFORMATION.

UTILITY QUALITY LEVEL D

INFORMATION DERIVED FROM EXISTING RECORDS OR ORAL RECOLLECTIONS.

UTILITY NOTES

- FACILITIES (UTILITY LINES) SHALL BE LOCATED AND MARKED PRIOR TO EXCAVATION. CALL (800) 90-BELOW.
- CONTRACTOR SHALL HAND-EXPOSE TO A POINT OF NO CONFLICT 24" ON EITHER SIDE OF THE UNDERGROUND FACILITY, REGARDLESS OF THE ESTIMATED DEPTH.
- DEPTHS SHOWN ARE APPROXIMATE, ESTIMATED DEPTHS ARE FROM THE GROUND SURFACE TO THE CENTER OF THE FACILITY, INVERT OF WASTE LINES, OR TO THE FACILITY TRACER WIRE. DEPTH ESTIMATES SHOULD BE USED WITH CAUTION AND MAY VARY ALONG THE LENGTH OF THE FACILITY.
- UTILITY BRACKETS ARE SHOWN TO DEMONSTRATE MULTIPLE LINES TRAVELING TOGETHER IN EITHER A DUCTBANK OR BUNDLE.
- THE SCOPE OF THIS SURVEY DOES NOT INCLUDE FACILITY SIZE OR NUMBER OF CONDUIT IN MULTIPLE CONDUIT RUNS. IRRIGATION LINES ARE NOT INCLUDED IN THIS SURVEY.
- THE BACKGROUND SITE PLAN USED IN PREPARING THIS MAP WAS PREPARED BY OTHERS AND PROVIDED TO C BELOW BY THE CLIENT. C BELOW MAKES NO REPRESENTATION AS TO THE ACCURACY OF THE PLAN.
- IN THE EVENT THE INFORMATION SHOWN IN THIS PLAN VARIES FROM THE ACTUAL SITE CONDITIONS, C BELOW SHALL BE NOTIFIED WITHIN 24 HOURS AFTER DISCOVERY OF THE CONFLICT.

UNDERGROUND LINE LEGEND

UTILITY QUALITY LEVEL B:

ELECTRICAL	— E —
GAS	— G —
COMMUNICATION	— C —
WATER	— W —
SANITARY SEWER	— SS —
STORM DRAIN	— SD —
POSSIBLE LINE LOCATION, BASED ON GPR DETECTION	— U —
STREET LIGHT	— SL —
AIR	— AIR —
TRAFFIC SIGNAL	— TS —
FIRE WATER	— FW —
CHILLED WATER	— CHW —
HOT WATER	— HW —
RECLAIMED WATER	— RW —

UTILITY QUALITY LEVEL C:

ELECTRICAL	- - - E - - -
GAS	- - - G - - -
COMMUNICATION	- - - C - - -
WATER	- - - W - - -
SANITARY SEWER	- - - SS - - -
STORM DRAIN	- - - SD - - -
STREET LIGHT	- - - SL - - -
AIR	- - - AIR - - -
TRAFFIC SIGNAL	- - - TS - - -
FIRE WATER	- - - FW - - -
CHILLED WATER	- - - CHW - - -
HOT WATER	- - - HW - - -
RECLAIMED WATER	- - - RW - - -

UTILITY QUALITY LEVEL D:

ELECTRICAL	— E —
GAS	— G —
COMMUNICATION	— C —
WATER	— W —
SANITARY SEWER	— SS —
STORM DRAIN	— SD —
STREET LIGHT	— SL —
AIR	— AIR —
TRAFFIC SIGNAL	— TS —
FIRE WATER	— FW —
CHILLED WATER	— CHW —
HOT WATER	— HW —
RECLAIMED WATER	— RW —

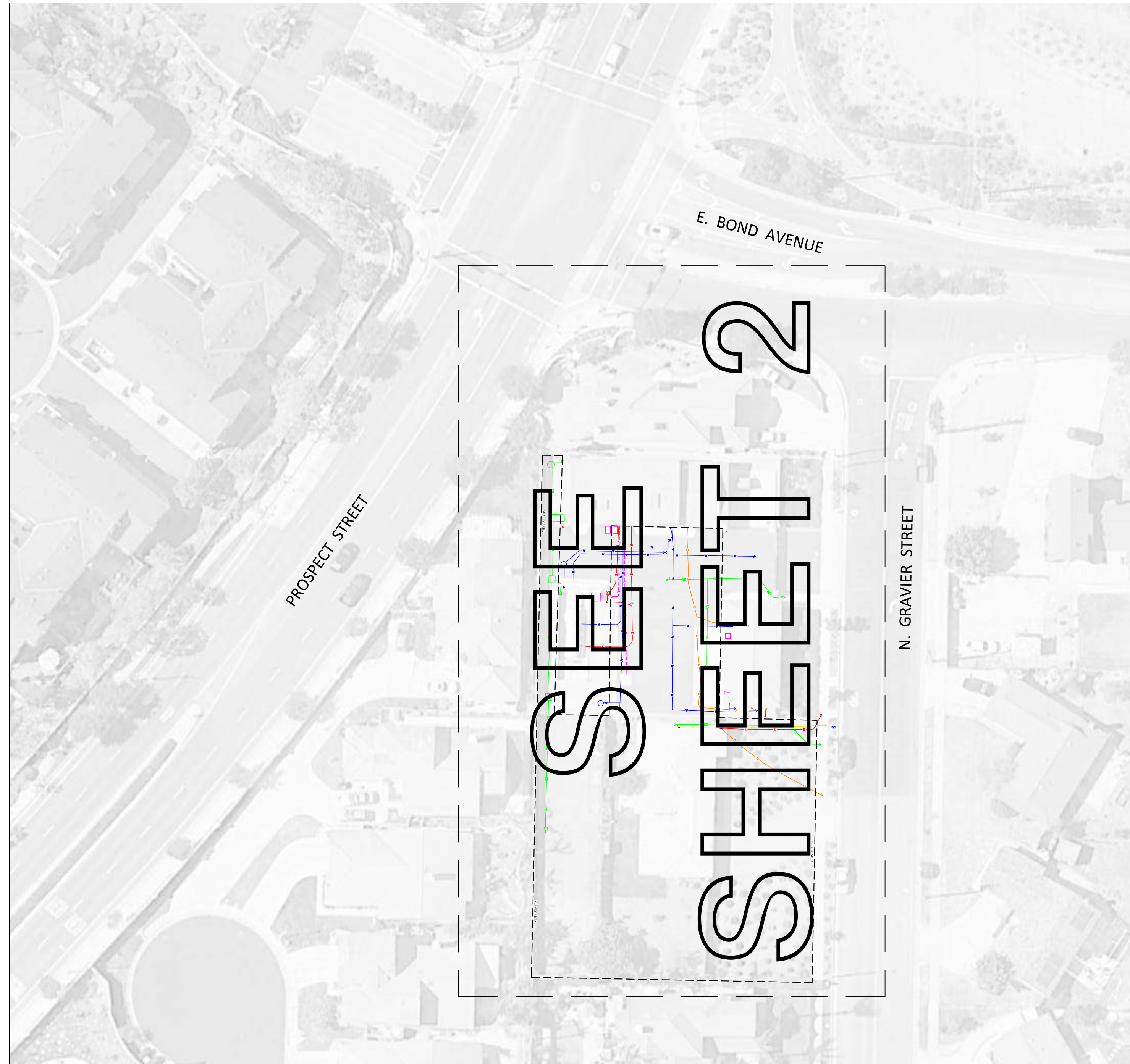

KEY MAP
NOT TO SCALE

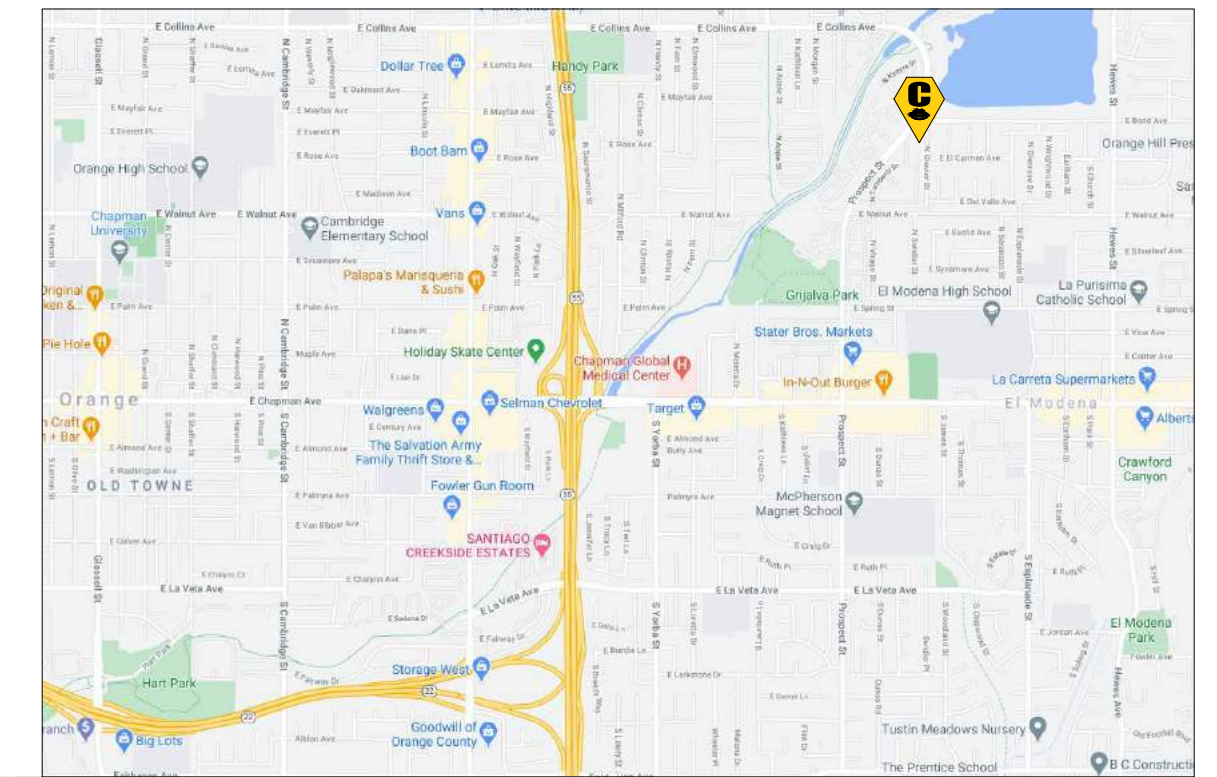

VICINITY MAP
NOT TO SCALE

KEY NOTES

- NON-CONDUCTIVE, UNABLE TO LOCATE PAST THIS POINT.
- NO ACCESS, UNABLE TO LOCATE PAST THIS POINT.
- CANNOT PUSH FURTHER PAST THIS POINT.
- AT BUILDING

ABBREVIATIONS

(C)	COMMUNICATION
(E)	ELECTRIC
(G)	GAS
MH	MANHOLE
PB	PULL BOX
(SD)	STORM DRAIN
(SS)	SANITARY SEWER
(U)	UNKNOWN
(W)	WATER

LEGEND/SYMBOL

○	CLEAN OUT
↙ 1'-6"	DEPTH FROM SURFACE
↘ 1'-6"	INVERT DEPTH FROM TOP OF GRATE
⊙	LIGHT POLE
○	MANHOLE
⊗	METER
⊕	VALVE
□	VAULT

UTILITY DEPICTION

UNDERGROUND UTILITY DEPICTION SHOWN HEREON IS BASED ON LOCAL CONTROL AND/OR ON THE SMARTNET RTK NETWORK, UNLESS STATED OTHERWISE.

DRAWING SHEETS	
SHEET NO.	SHEET TITLE
1	COVER SHEET
2	UTILITY MAP



C BELOW SUBSURFACE IMAGING
14280 EUCLID AVE
CHINO, CA 91710
P: 888-902-3569
F: 909-606-6555
www.cbellow.com

GROUND PENETRATING RADAR (GPR)
UTILITY LOCATING
RADIOGRAPHY
POTHOLING
MAPPING

NOTES: The services provided by C Below, Inc. do not relieve the Client and/or property owner of the responsibility of having to comply with California Government Code §54216-4216.9. It is expressly understood by the Client and/or owner that CBSI services are not a substitute for compliance with California Code §54216-4216.9.

PROJECT:
PARTIAL UNDERGROUND UTILITY MAP FOR:
IRVINE RANCH WATER DISTRICT
678 N. GRAVIER STREET
ORANGE, CA 92869

CLIENT:
AECOM
999 TOWN AND COUNTRY ROAD
ORANGE, CA 92868

REVISIONS			
NO	DATE	BY	DESCRIPTION

DATE LOCATED: 2/2021
DRAWN BY/DATE: LB 2/26/2021
TECHNICIAN: B. TRAHAN
CHECK BY/DATE: A. LOPEZ
QC CHECKED BY/DATE: OG 3/01/2021
DRAWING NAME: COVER SHEET
PROJECT NO: 20-3097
SCALE: N.T.S.

SHEET 1 OF 2

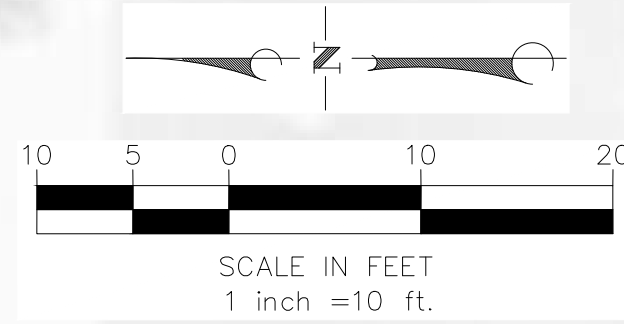

NOTE:
BACKGROUND IMAGE IS FROM GOOGLE
EARTH AND IS FOR REFERENCE ONLY.

NO BACKGROUND HAS BEEN PROVIDED BY
CLIENT. ONCE BACKGROUND IS PROVIDED
UTILITY MAP WILL BE UPDATED

SEE SHEET 1 FOR ABBREVIATIONS, LINE/
SYMBOL LEGENDS, KEY NOTES AND UTILITY
NOTES

N. GRAVIER STREET

E. BOND AVENUE

PROSPECT STREET

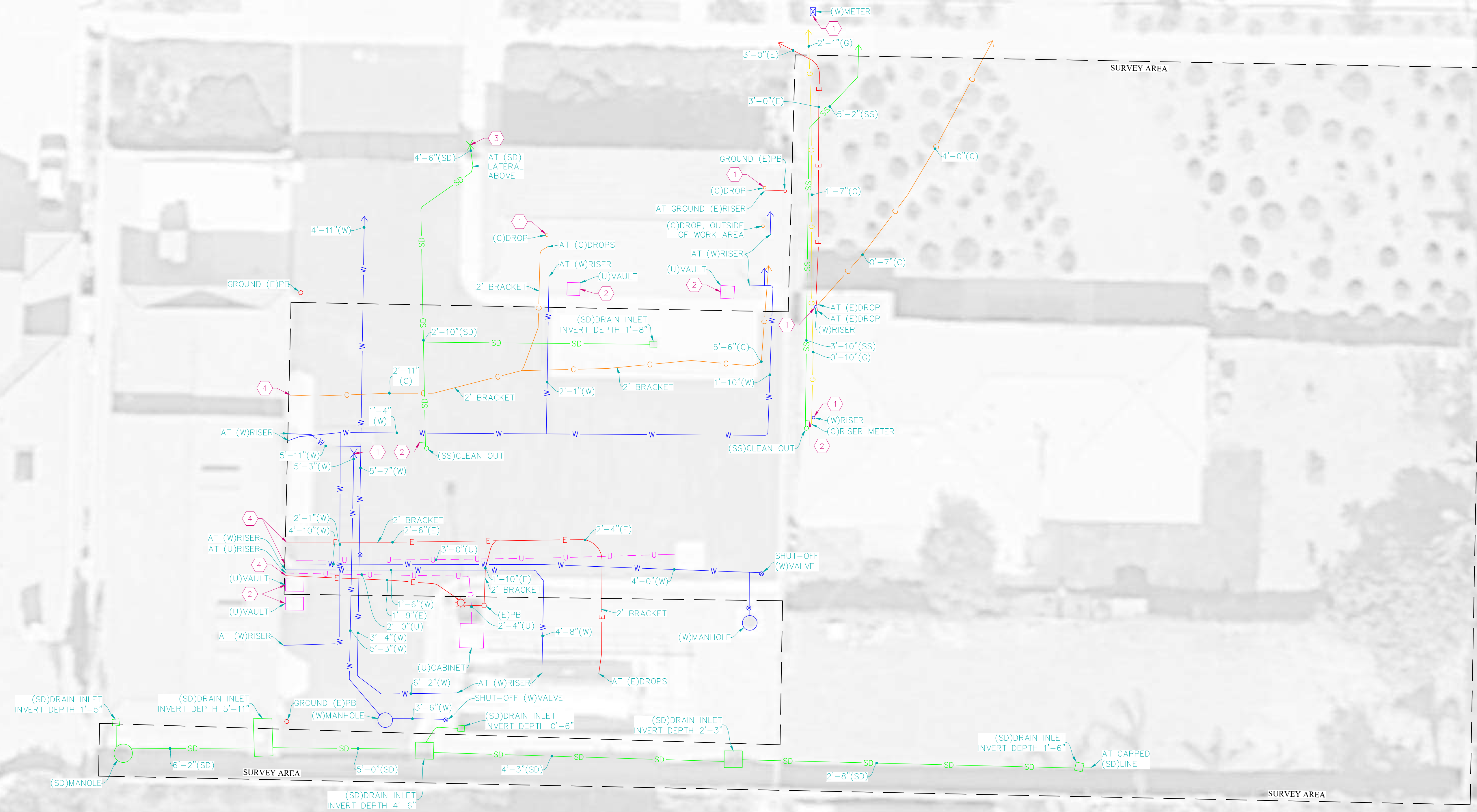

C BELOW SUBSURFACE IMAGING
14280 EUCLID AVE
CHINO, CA 91710
P: 888-902-3569
F: 909-606-6555
www.cbelow.com

GROUND PENETRATING RADAR (GPR)
UTILITY LOCATING
RADIOGRAPHY
POTHOLING
MAPPING

NOTES: The services provided by C Below, Inc. do not relieve the Client and/or property owner of the responsibility of having to comply with California Government Code §54216-4216.9. It is expressly understood by the Client and/or owner that CBSI services are not a substitute for compliance with California Code §54216-4216.9.

PROJECT:
PARTIAL UNDERGROUND UTILITY MAP FOR:
IRVINE RANCH WATER DISTRICT
678 N. GRAVIER STREET
ORANGE, CA 92869

CLIENT:
AECOM
999 TOWN AND COUNTRY ROAD
ORANGE, CA 92868

REVISIONS			
NO	DATE	BY	DESCRIPTION

DATE LOCATED: 2/2021
DRAWN BY/DATE: LB 2/26/2021
TECHNICIAN: B. TRAHAN
CHECK BY/DATE: A. LOPEZ
QC CHECKED BY/DATE: OG 3/01/2021
DRAWING NAME: UTILITY MAP
PROJECT NO: 20-3097
SCALE: 1" = 10'

Appendix C: Geotechnical Investigation



Converse Consultants

Geotechnical Engineering
Environmental & Groundwater Science
Inspection & Testing Services

GEOTECHNICAL INVESTIGATION REPORT

OCWD PFAS TREATMENT FACILITY
ORANGE PARK ACRES WELL NO. 1 WELLHEAD FACILITIES
678 NORTH GRAVIER STREET
CITY OF ORANGE, CALIFORNIA

CONVERSE PROJECT NO. 20-32-172-01

Prepared For:

AECOM

Mr. Alex Franchi, PhD, PE, BCEE
US West Region Water Process Practice Lead
999 Town and Country Road
Orange, California 92868

Presented By:

CONVERSE CONSULTANTS

717 South Myrtle Avenue
Monrovia, California 91016
626-930-1200

April 2, 2021



Converse Consultants

75 Years of Dedication in Geotechnical Engineering & Consulting, Environmental & Groundwater Science,
Materials Testing & Inspection Services

April 2, 2021

Mr. Alex Franchi, PhD, PE, BCEE
US West Region Water Process Practice Lead
AECOM
999 Town and Country Road
Orange, California 92868

Subject: **GEOTECHNICAL INVESTIGATION REPORT**
OCWD PFAS Treatment Facility
Orange Park Acres Well No. 1 Wellhead Facilities
678 North Gravier Street
City of Orange, California
Converse Project No. 20-32-172-01

Dear Mr. Franchi:

Converse Consultants (Converse) has prepared this report to present the results of our geotechnical investigation conducted to assist with the design of the proposed OCWD PFAS Treatment Facility located at 678 North Gravier Street in the City of Orange, California. This report was prepared in accordance with our proposal dated November 24, 2020 and your subcontract with PO No. 131760 effective February 1, 2021.

Based on the results of our field exploration, laboratory testing and engineering analysis, we conclude that the site is suitable for the proposed development from a geotechnical standpoint provided the recommendations presented in this report are incorporated during the design and construction of the project.

We appreciate the opportunity to be of service to AECOM. Should you have any questions, please do not hesitate to contact us at (626) 930-1200.

Sincerely,

CONVERSE CONSULTANTS

A handwritten signature in blue ink that reads "Carlos V. Amante".

Carlos V. Amante, PE, GE
Principal Engineer/Managing Officer

PROFESSIONAL CERTIFICATION

This report has been prepared by the staff of Converse under the professional supervision of the individuals whose seals and signatures appear hereon.

The findings, recommendations, specifications, or professional opinions contained in this report were prepared in accordance with generally accepted professional engineering and engineering geologic principles and practice in this area of Southern California. There is no warranty, either expressed or implied.



Babak Abbasi, PhD, EIT
Senior Staff Engineer



Mark Schluter, PG, CEG, CHG
Senior Engineering Geologist

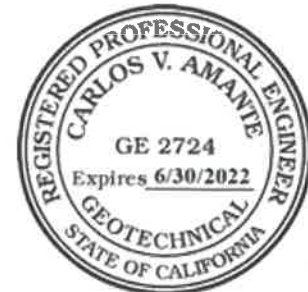

Carlos V. Amante, PE, GE
Principal Engineer/Managing Officer



EXECUTIVE SUMMARY

The following is a summary of our geotechnical investigation, conclusions and recommendations as presented in this report. Please refer to the pertinent section of this report for complete conclusions and recommendations. In the event of a conflict between this summary and the report, or an omission in the summary, the report shall prevail.

- The proposed PFAS treatment facility will be located at the existing house (660 North Gravier Street), south of Well No. 1 wellhead facilities, operated by IRWD. The site is surrounded to the west, and south by residential neighborhoods, and to the east by Gravier Street. The Santiago Creek Recharge Basin is located across East Bond Avenue immediately to the northeast of the project site. The Well No. 1 is presently occupied with chemical building, surge tank, Well No. 1 pump facility, electrical room, and electrical transformer. The existing house owned by IRWD will be demolished and the PFAS treatment facility will be constructed at the site. The surface elevation of the project site is approximately 290 feet above mean sea level (amsl).
- Based on information provided by Alex Franchi with AECOM, two options are proposed for the location of new PFAS treatment facility and associated improvements. For the first option, the PFSA facility will be located west of project site with a 34-foot-wide driveway at east side of facility. The water treatment system will be supported on an approximately 41 feet x 50 feet concrete pad. For the second option, the proposed PFAS facility will be located south of project site with a 30-foot-wide access driveway at north side of facility. The water treatment system will be supported on an approximately 41 feet x 49 feet concrete pad. For both options, the elevation of top of concrete pad will be approximately 10 feet below existing ground surface. The project also includes construction of a pipeline that runs from the treatment plant to Well No. 1 wellhead facilities. The maximum depth to pipe invert will be approximately 15 feet below existing ground surface.
- To investigate the subsurface conditions at the project site, two (2) exploratory borings (BH-1 and BH-2) were drilled on February 25, 2021 to the planed depth of 26.5 feet below ground surface (bgs). The approximate locations of the borings are shown on Drawing No. 2, *Boring Location Map*. A detailed discussion of the field exploration program and boring logs are presented in Appendix A, *Field Exploration*.
- The subsurface soil conditions consisted of artificial fill underlain by native alluvial deposits. Artificial fill was encountered in the borings to a maximum depth of 6.5 feet bgs. The fill material consists of poorly graded gravels with silt (GP-GM), possibly brought to the site during the previous site grading and development. The native alluvial sediments consisted of poorly graded gravels and silty sands. Gravel and cobbles up to 5.0 inches in largest dimension were encountered during



drilling. Broken pieces of rocks were also encountered, indicating that cobbles larger than 5.0 inches and possible boulders are present in the site subsurface.

- Groundwater was not encountered in any of our borings to a maximum explored depth of 26.5 feet bgs. Based on a regional database (SWRCB, 2020), groundwater levels at site location #L10009578462 in Well MW-4 located approximately 1.4 miles northeast of the project site, was measured to 19.45 feet bgs in May, 2020. The historical highest groundwater level contour at the site is reported to be between 25 and 30 feet bgs (CGS, 1997).
- The site is not located within a current State of California Earthquake Fault Zone. Based on review of available geologic information, no major surface fault crosses through or extends towards the site. The potential for surface rupture resulting from the movement of nearby major faults, or currently unknown faults, is not known with certainty but is considered low.
- The project site is located in an area designated as susceptible to potential liquefaction by the State of California (CGS, 1999). Based on liquefaction analysis, liquefaction of saturated soils at the project site is unlikely to occur. The potential for surface manifestations of liquefaction, such as sand boils and surface fissures are considered to be low.
- Seismic settlement due to densification of soil particles during ground shaking is in the order of 1.6 inches. The seismic differential settlement may be taken as equal to one-half of the total settlement over 30 horizontal feet.
- The risk to the site from lateral spreading, landslides, and tsunamis is considered to be low. Seiching in the Santiago Creek Recharge Basin, located across East Bond Avenue immediately northeast of the project site, could result in site flooding. The project site is located downstream approximately 3.6 miles from the Villa Park Dam and 7.5 miles from the Santiago Dam. Failure of either one of these dams during an earthquake may result in flooding of the project site.
- Mapped and site-specific seismic design parameters based on the current (2019) Building Code are presented in Table Nos. 2 and 3, respectively.
- The sulfate contents of the sampled soils correspond to American Concrete Institute (ACI) exposure category S0 for these sulfate concentrations. No concrete type restrictions are specified for exposure category S0. A minimum compressive strength of 2,500 psi is recommended. The chloride contents of the sampled soils correspond to American Concrete Institute (ACI) exposure category C1 (concrete is exposed to moisture, but not to external sources of chlorides). For exposure category C1, ACI provides concrete compressive strength of at least 2,500 psi and a maximum chloride content of 0.3 percent.



- Based on the soil corrosivity test results, the soils are considered moderately corrosive to concrete and ferrous metals. According to ACI 318-14, a minimum compressive strength of 2,500 psi and maximum chloride content of 0.3 percent are recommended for concrete based on sulfate and chloride exposure categories. Additional corrosion testing should be performed at the completion of grading or as recommended by a qualified corrosion consultant. Converse does not practice in the area of corrosion consulting. A qualified corrosion consultant should provide appropriate corrosion mitigation measures.
- Based on our subsurface exploration, we anticipate that the site soils will be excavatable with conventional heavy-duty earthmoving equipment. Gravels and cobbles were encountered in our borings and will be encountered during grading and construction. Boulders may also be encountered during construction. These oversized rocks may result in difficult excavation. As discussed in Section 8.4, Engineering Fill, oversized materials larger than 3 inches are not suitable for use in compacted fill and should be removed if the excavated soil is to be re-used as compacted fill. Oversized rocks should be disposed of offsite. Excavated onsite earth materials cleared of deleterious matter and oversize rock can be moisture conditioned and re-used as compacted fill.
- To provide uniform support for the proposed foundations, the existing soils should be over-excavated and replaced with engineered fill to a minimum depth of 3 feet below the bottom of foundations, or 5 feet below the lowest adjacent grade, whichever is deeper. The over-excavation and re-compaction should extend laterally at least 5 feet beyond the footprints of the foundations. The over-excavation and re-compaction should be deepened as needed to remove any existing fill, and any very soft or saturated soil. The bottom of excavation should be scarified to a depth of 8 inches and compacted to at least 90 percent of the laboratory maximum dry density as determined by ASTM D1557 test method.
- Fill soils should be placed on scarified and recompacted excavation bottoms, moisture conditioned, and compacted to at least 90 percent of the laboratory maximum dry density. A minimum of 12 inches of fill beneath pavement intended to support vehicle loads should be compacted to at least 95 percent of the laboratory maximum dry density.
- Shallow foundation and mat foundation design parameters and recommendations are presented in Sections 9.1 and 9.2, respectively.
- The settlement due to static loading of the foundations, designed as recommended above, from structural load-induced loads is anticipated to be less than one-half (0.5) inch. Differential settlement due to structural loadings is anticipated to be less than one quarter (0.25) inches. The site has a potential for seismic settlement of



1.6 inches. The seismic differential settlement may be estimated to be up to one-half of the total settlement in horizontal span of 30 feet. The static and seismic settlements should be considered cumulatively in the design of the onsite structures. The total static and seismic differential settlement is anticipated to be in order of one (1) inch in horizontal span of 30 feet.

- Recommendations on lateral earth pressures and resistance to lateral loads are presented in Section 9.3.

Based on our investigation, it is our professional opinion that the site is suitable for the construction of the proposed improvements provided the recommendations presented in this geotechnical investigation report are implemented in the planning, design, and construction of the project.



TABLE OF CONTENTS

1.0	INTRODUCTION-----	1
2.0	SITE AND PROJECT DESCRIPTION-----	1
3.0	SCOPE OF WORK-----	2
3.1	EXISTING DOCUMENT REVIEW-----	2
3.2	PROJECT SET-UP-----	2
3.3	SUBSURFACE EXPLORATION-----	2
3.4	LABORATORY TESTING-----	2
3.5	ENGINEERING ANALYSES AND GEOTECHNICAL REPORT PREPARATION-----	3
4.0	GEOLOGIC SETTING-----	3
4.1	REGIONAL GEOLOGY-----	3
4.2	SITE GEOLOGY-----	4
5.0	SUBSURFACE CONDITIONS-----	4
5.1	SUBSURFACE PROFILE-----	4
5.2	GROUNDWATER-----	4
5.3	SUBSURFACE VARIATIONS-----	5
5.4	EXCAVATABILITY-----	5
5.5	FLOODING-----	5
6.0	FAULTING AND SEISMICITY-----	5
6.1	FAULTING-----	5
6.2	HISTORIC SEISMICITY-----	7
6.3	SEISMIC HAZARD ANALYSIS-----	7
6.4	SECONDARY EFFECTS OF SEISMIC ACTIVITY-----	8
7.0	LABORATORY TEST RESULTS-----	11
7.1	PHYSICAL TESTING-----	11
7.2	CHEMICAL TESTING - CORROSIVITY EVALUATION-----	12
8.0	EARTHWORK RECOMMENDATIONS-----	12
8.1	GENERAL-----	13
8.2	REMEDIAL GRADING-----	13
8.3	BACKFILL RECOMMENDATIONS BEHIND WALL-----	14
8.4	ENGINEERED FILL-----	15
8.5	COMPACTED FILL PLACEMENT-----	15
8.6	SHRINKAGE AND SUBSIDENCE-----	16
8.7	SITE DRAINAGE-----	16
9.0	DESIGN RECOMMENDATIONS-----	16
9.1	SHALLOW FOUNDATION DESIGN PARAMETERS-----	16
9.2	MAT FOUNDATION DESIGN PARAMETERS-----	17
9.3	LATERAL EARTH PRESSURES AND RESISTANCE TO LATERAL LOADS-----	18
9.4	SETTLEMENT-----	19



9.5	SLABS-ON-GRADE -----	19
9.6	SOIL CORROSIVITY-----	21
9.7	CONCRETE FLATWORK-----	21
9.8	BEARING PRESSURE FOR ANCHOR AND THRUST BLOCKS -----	22
10.0	CONSTRUCTION RECOMMENDATIONS -----	22
10.1	GENERAL -----	22
10.2	TEMPORARY SLOPED EXCAVATIONS-----	23
10.3	SHORING DESIGN -----	23
11.0	GEOTECHNICAL SERVICES DURING CONSTRUCTION -----	24
12.0	CLOSURE -----	25
13.0	REFERENCES -----	26

Drawings

	Following Page Number
Drawing No. 1, Site Location Map	1
Drawing No. 2, Boring Location Map	2
Drawing No. 3, Regional Geologic Map	3
Drawing No. 4, Southern California Regional Fault Map	6
Drawing No. 5, Epicenter Map of Southern California Earthquakes (1800-1999)	7
Drawing No. 6, Seismic Hazard Zones Map	9
Drawing No. 7, Recommended Lateral Earth Pressure for Braced Excavation	24

Tables

	Page Number
Table No. 1, Summary of Regional Faults	6
Table No. 2, 2019 CBC Mapped Seismic Parameters	7
Table No. 3, 2019 CBC Site-Specific Seismic Parameters	8
Table No. 4, Recommended Foundation Design Parameters	17
Table No. 5, Recommended Lateral Earth Pressures	18
Table No. 6, Slope Ratios for Temporary Excavations	23

Appendices

Appendix A	Field Exploration
Appendix B	Laboratory Testing Program
Appendix C	Seismic Hazard Analysis Results
Appendix D	Liquefaction and Seismic Settlement Analysis Results



1.0 INTRODUCTION

This report presents the results of our geotechnical investigation performed for the OCWD PFAS Treatment Facility Project, located at 678 North Gravier Street, in the City of Orange, Orange County, California. The approximate location of facility is shown on Drawing No. 1, *Site Location Map*.

The purposes of this investigation were to determine the nature and engineering properties of the subsurface soils, to conduct a geohazard evaluation of the site, and provide recommendations for seismic design, site earthwork, and design and construction of foundations for the proposed development.

This report is prepared for the project described herein and is intended for use solely by AECOM, Irvine Ranch Water District (IRWD), and their authorized agents for design purposes. It should not be used as a bidding document but may be made available to the potential contractors for information on factual data only. For bidding purposes, the contractors should be responsible for making their own interpretation of the data contained in this report.

2.0 SITE AND PROJECT DESCRIPTION

The project site is located on the southwest side of the intersection of East Bond Avenue and North Gravier Street in the City of Orange, Orange County, California. The site is surrounded to the west and south by residential neighborhoods, and to the east by Gravier Street. The Santiago Creek Recharge Basin is located across East Bond Avenue immediately to the northeast of the project site. The proposed PFAS treatment facility will be located at the existing house (660 North Gravier Street), south of Well No. 1 wellhead facilities, operated by IRWD. The Well No. 1 is presently occupied with chemical building, surge tank, Well No. 1 pump facility, electrical room, and electrical transformer. The existing house owned by IRWD will be demolished and a new treatment facility will be constructed at the site. The surface elevation of the project site is approximately 290 feet above mean sea level (amsl).

Based on information provided by Alex Franchi with AECOM, two options are proposed for the location of new PFAS treatment facility and associated improvements. For the first option, the PFSA facility will be located west of project site with a 34-foot-wide driveway at east side of facility. The water treatment system will be supported on an approximately 41 feet x 50 feet concrete pad. For the second option, the proposed PFAS facility will be located south of project site with a 30-foot-wide access driveway at north side of facility. The water treatment system will be supported on an approximately 41 feet x 49 feet concrete pad. For both options, the elevation of top of concrete pad will be approximately 10 feet below existing ground surface. The project also includes construction of a pipeline



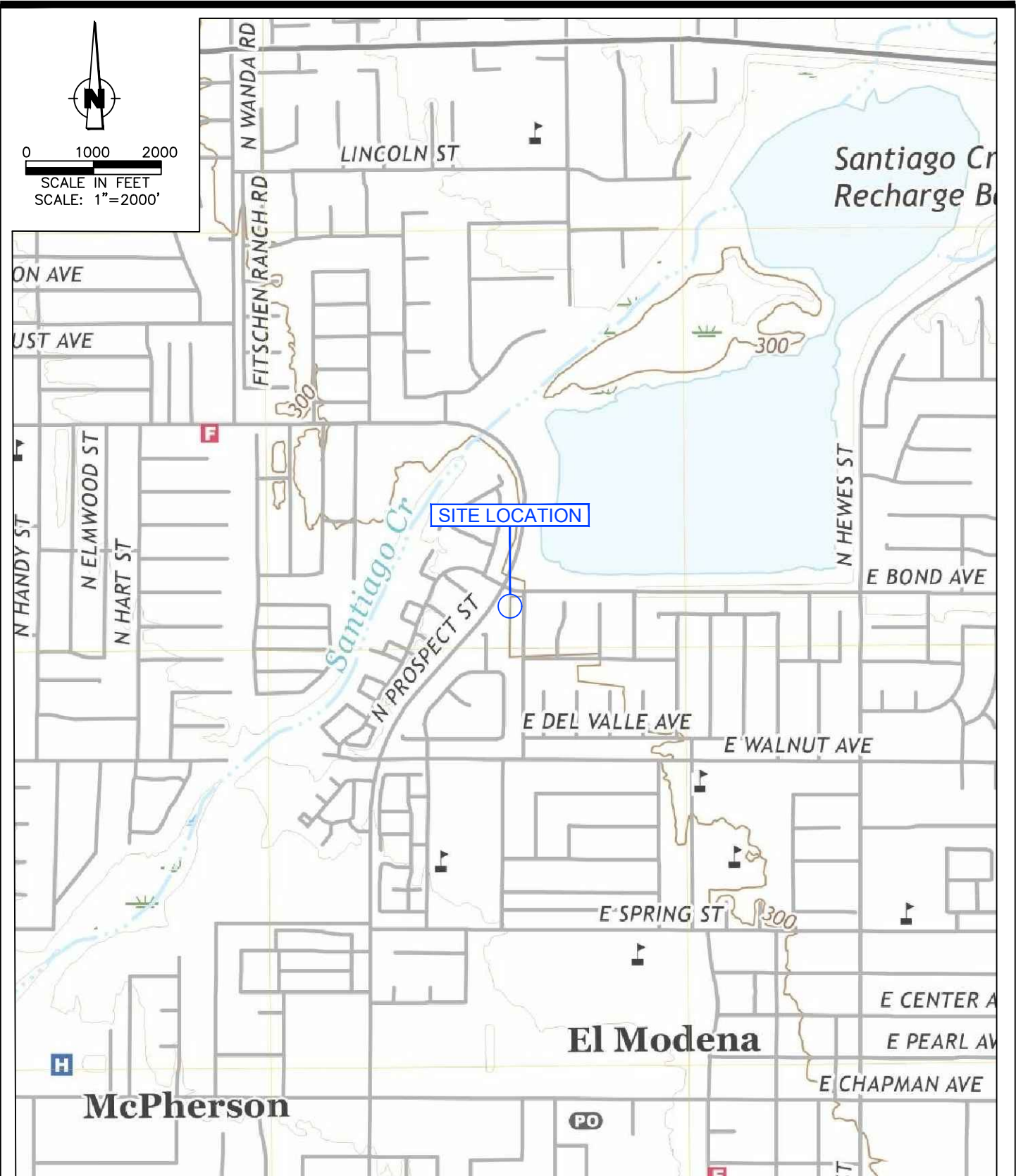

SITE LOCATION MAP

OCWD PFAS Treatment Facility
 Orange Park Acres Well No. 1 Wellhead Facilities
 678 N. Gravier Street
 City of Orange, California

Project No.
 20-32-172-01



Drawing No.

1

that runs from the treatment plant to Well No. 1 wellhead facilities. The maximum depth to pipe invert will be approximately 15 feet below existing ground surface.

3.0 SCOPE OF WORK

The scope of Converse's investigation included the tasks described in the following sections.

3.1 Existing Document Review

Converse reviewed available existing report and as-built utility plans for the project. Besides the existing report by Converse, we reviewed geohazard and groundwater maps to evaluate any impact on the design and construction of the proposed project.

3.2 Project Set-up

The project set-up consisted of the following tasks.

- Conducted a site reconnaissance and marked the exploration locations, such that equipment access to all the locations was available.
- Coordinated with the representative AECOM to clear the exploration locations for underground utilities.
- Notified Underground Service Alert (USA) at least 48 hours prior to field work to clear the exploration locations of any conflict with existing underground utilities.
- Engaged a California licensed drilling subcontractors.

3.3 Subsurface Exploration

To investigate the subsurface conditions at the project site, two (2) exploratory borings (BH-1 and BH-2) were drilled on February 25, 2021 to depth of 26.5 feet below ground surface (bgs). The approximate locations of the borings are shown on Drawing No. 2, *Boring Location Map*. A detailed discussion of the field exploration program and boring logs are presented in Appendix A, *Field Exploration*.

3.4 Laboratory Testing

Representative samples of the site soils were tested in the laboratory to aid in the classification and to evaluate relevant engineering properties. The tests performed included the following.

- *In Situ* Moisture Content and Dry Density (ASTM Standard D2216 and D7263)
- Soil Corrosivity (California Test 643, 422, and 417)
- Grain Size Distribution (ASTM Standard C136)





BORING LOCATION MAP

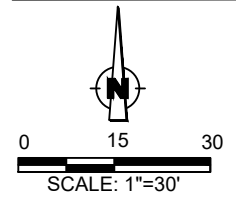

LEGEND
 BH-1 APPROXIMATE BORING LOCATION



OCWD PFAS Treatment Facility
 Orange Park Acres Well No. 1 Wellhead Facilities
 678 N. Gravier Street
 City of Orange, California

PROJECT NO.
 20-32-172-01

DRAWING NO.
 2

- Maximum Dry Density and Optimum Moisture Content (ASTM Standard D1557)
- Direct Shear Strength (ASTM Standard D3080)
- Swell/Collapse (ASTM Standard D4546)
- Atterberg Limits (ASTM Standard D4318)

For *in situ* moisture and density data, see the Logs of Borings in Appendix A, *Field Exploration*. For a description of the other laboratory test methods and test results, see Appendix B, *Laboratory Testing Program*.

3.5 Engineering Analyses and Geotechnical Report Preparation

Data obtained from the field exploration and laboratory testing program was compiled and evaluated. Geotechnical analyses of the compiled data were performed, and this report was prepared to present our findings, conclusions, and recommendations for the proposed improvements.

4.0 GEOLOGIC SETTING

The regional and local geology are discussed in the following subsections.

4.1 Regional Geology

The project site is located within the Peninsular Ranges Geomorphic Province of California. The Peninsular Ranges province is characterized by northwest trending valleys and mountain ranges, which have formed in response to regional tectonic forces along the boundary between the Pacific and North American tectonic plates. The geologic structure is dominated by the northwest trending right-lateral faults, most notable, the San Andreas fault, San Jacinto fault, Elsinore fault, Whittier fault, and the Newport-Inglewood fault. The province extends southward from the Transverse Ranges province at the north end of the Los Angeles basin to the southern tip of the Baja California Peninsula.

The project site is situated on a broad alluvial basin along the eastern portion of the Orange County coastal plain. The coastal plain has been gradually filled with Quaternary-age sediments. The Santa Ana River, Santiago Creek and local drainage tributaries have deposited stream sediments across the coastal plain during Holocene time (0-11,000 years) to form a relatively flat and broad river flood plain. Most of the river and stream channel flows are now controlled by an extensive network of flood control channels and storm drains which drain to the Santiago Creek and Santa Ana River flood control channels and then to the Pacific Ocean. Please see Drawing No. 3, *Regional Geologic Map*.



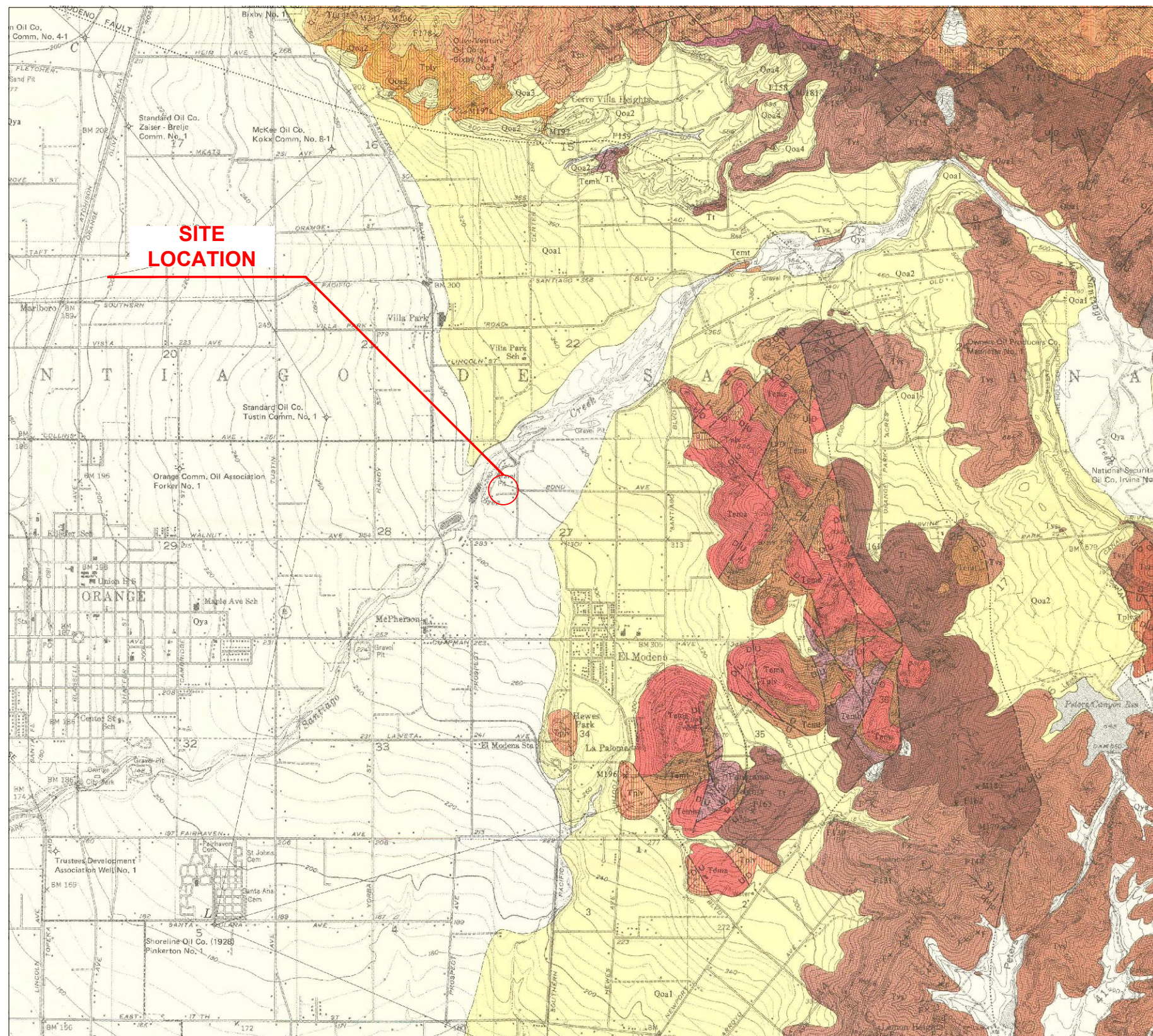
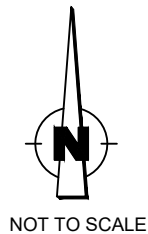

EXPLANATION	
<p>Qya Younger alluvium Gravel, sand, and silt</p>	
<p>Qoa1 Qoa2 Qoa3 Qoa4 Older alluvium Sand, gravel, and rubble, locally reddish brown in color. Terrace surfaces along Santiago Creek have been tentatively correlated, and each terrace is numbered in order of age. Qoa1, the youngest</p>	
<p>Qh La Habra Formation White massive poorly sorted pebbly sandstone, yellowish-brown, reddish-brown, and greenish-gray sandy mudstone, earthy sandstone and conglomerate; nonmarine. Exposed north of Santa Ana River, present in subsurface only south of river</p>	<p>Qda Deformed alluvial deposits Gray to reddish-brown rubble and gravel; faulted & folded</p>
<p>Ttu Upper member Brownish-yellow to greenish-gray conglomerate sandstone, and micaceous siltstone</p>	<p>Ts Brownish-yellow conglomerate and interbedded sandstone</p>
<p>Ttl Lower member Greenish-gray massive to moderately well bedded micaceous siltstone and sandstone with minor amounts of conglomerate</p>	
<p>Tps Sycamore Canyon Member Brownish-yellow to gray fine- to coarse-grained sandstone with interbedded gray micaceous siltstone</p>	
<p>Tpy Yorba Member Chocolate-brown to pinkish-gray massive to well-laminated siltstone, light-gray laminated siltstone and diatomaceous siltstone, yellowish-brown limy siltstone concretions, thin-bedded sandstone</p>	<p>Tso Oso Member White medium- to coarse-grained massive sandstone and</p>
<p>Tps Soquel Member Brownish-yellow to gray medium-grained to pebbly sandstone, interbedded gray micaceous siltstone, local conglomerate</p>	<p>Tpl La Vida and Yorba Members, undifferentiated Light-gray, chocolate-brown, and black siltstone, diatomaceous siltstone, thin-bedded sandstone</p>
<p>Tpl La Vida Member Chocolate-brown to black siltstone, locally contains phosphatic nodules and thin-bedded sandstone tu2, white vitric tuff in southeast corner of area ss, lenticular sandstone, conglomerate, and breccia tuff, buff sandy andesitic tuff or volcanic sandstone locally lying between Puente and Topanga Formations</p>	<p>Tm Monterey Shale White to gray punky siltstone and shale and thin-bedded</p>
<p>Tena Andesite flows and flow breccia Red, buff, and gray vesicular andesite flows and flow breccias; interbedded tuffaceous and limy breccias</p>	
<p>Temt Palagonite tuff and tuff-breccia Light-buff palagonite tuff and tuff-breccia of andesitic composition, in part water-laid</p>	
<p>Temh Basalt flows Gray to black vesicular porphyritic olivine basalt flows, locally overlain by thin-bedded limy organic siltstone</p>	<p>Tem El Modeno Volcanics, undifferentiated Interbedded andesite and basalt flows, flow breccias, palagonite tuff and tuff-breccia</p>

REFERENCE: THOMAS W. DIBBLE, Jr. (DF-91)
SANTA ANA QUADRANGLE 1999

REGIONAL GEOLOGIC MAP



OCWD PFAS Treatment Facility
Orange Park Acres Well No. 1 Wellhead Facilities
678 N. Gravier Street
City of Orange, California

Project No. Drawing No.
20-32-172-01 3

4.2 Site Geology

The project site is underlain by Pleistocene to Holocene unconsolidated alluvial fan deposits, which are primarily composed of mixtures of gravels, sands and silt (Morton and Miller, 2006). These deposits were derived from the weathering and erosion of the Santa Ana Mountains to the east, and then transported to the area via the Santiago Creek, which has a present day course approximately 0.2 miles northwest of the project site.

The near-surface alluvium is likely underlain by late to middle Pleistocene age old alluvial fan deposits.

5.0 SUBSURFACE CONDITIONS

A general description of the subsurface conditions and various materials encountered during our field exploration are presented in this section.

5.1 Subsurface Profile

5.1.1 Artificial Fill

Artificial fill was encountered in the borings to a maximum depth of 6.5 feet bgs. The fill material consists of poorly graded gravel with silt (GP-GM).

5.1.2 Alluvium

The alluvium materials encountered in the exploratory borings consisted predominantly of poorly graded gravel and silty sand. Gravel and cobbles up to 5.0 inches in largest dimension were encountered during drilling. Broken pieces of rocks were also encountered, indicating that cobbles larger than 5.0 inches and possible boulders are present in the site subsurface.

For a detailed description of the subsurface materials encountered in the exploratory borings, see Drawing Nos. A-3 and A-4, *Logs of Borings*, in Appendix A, *Field Exploration*.

5.2 Groundwater

Groundwater was not encountered in any of our borings to a maximum explored depth of 26.5 feet bgs. Based on a regional database (SWRCB, 2020), groundwater levels at site location #L10009578462 in well MW-4 located approximately 1.4 miles northeast of the project site, was measured to 19.45 feet bgs in May, 2020. The historical highest groundwater level contour at the site is reported to be between 25 and 30 feet bgs (CGS, 1997).



Groundwater is not expected to be encountered during the construction of this project. The groundwater level may vary depending upon the seasonal precipitation, infiltration from surface channels such as the nearby Santiago Creek, irrigation, and possible groundwater recharge and pumping activity in the site vicinity.

5.3 Subsurface Variations

Based on the results of subsurface exploration and our experience, some variations in the continuity and nature of subsurface conditions within the project site should be anticipated. Because of the uncertainties involved in the nature and depositional characteristics of the earth materials at the site, care should be exercised in interpolating or extrapolating subsurface conditions between or beyond the boring locations.

5.4 Excavatability

Based on our field exploration, the earth materials at the site should be excavatable with conventional heavy-duty earth moving and trenching equipment. Gravels and cobbles were encountered in our borings, and will be encountered during construction. Boulders may also be encountered during construction. These oversized rocks may result in difficult excavation. As discussed in Section 8.4, Fill Placement, oversized materials larger than 3 inches are not suitable for use in compacted fill and should be removed if the excavated soil is to be re-used as compacted fill. Oversized rocks should be disposed of offsite.

5.5 Flooding

Review of the Flood Insurance Rate Map (FEMA, 2009), Map Number 06059C0162J, dated December 3, 2009, from the FEMA Map Service Center Viewer, indicates that the site is in an area designated as Zone X, "Areas of 0.2% annual chance flood; areas of 1% annual chance flood with average depths less than 1 foot or with drainage areas less than 1 square mile." Due to the absence of groundwater at shallow depths, distance of the subject site from large bodies of water and regional flood control structures, the potential for flooding at the subject site is considered low.

6.0 FAULTING AND SEISMICITY

Discussion of faulting and seismicity is presented in the following sections.

6.1 Faulting

In California, the Alquist-Priolo Earthquake Fault Zoning Act regulates development in the vicinity of active faults. For purposes of the Act, California defines an active fault as one which has had surface displacement within Holocene time, or about the last 11,000 years.



The site is not located within a currently designated State of California Earthquake Fault Zone (CGS, 2007). Based on a review of existing geologic information no known active surface fault zone crosses or projects toward the site.

The proposed site is situated in a seismically active region. As is the case for most areas of Southern California, ground-shaking resulting from earthquakes associated with nearby and more distant faults may occur at the project site. During the life of the project, seismic activity associated with active faults can be expected to generate moderate to strong ground shaking at the site. The approximate locations of these local active faults with respect to the project site are shown on Drawing No. 4, *Southern California Regional Fault Map*.

The following table contains a list of active and potentially active faults within 50 kilometers of the subject site based on site coordinates of 33.7980 degrees North (latitude) and 117.8148 degrees West (longitude).

Table No. 1, Summary of Regional Faults

Fault Name and Section	Closest Distance (km)	Slip Sense	Length (km)	Slip Rate (mm/year)	Maximum Magnitude
Elsinore	11.63	strike slip	241	n/a	7.8
Puente Hills (Coyote Hills)	12.03	thrust	17	0.7	6.9
San Joaquin Hills	12.23	thrust	27	0.5	7.1
Chino, alt 2	19.5	strike slip	29	1	6.8
Chino, alt 1	19.55	strike slip	24	1	6.7
Elsinore;GI+T+J+CM	21.02	strike slip	195	n/a	7.7
Newport Inglewood Connected alt 2	21.4	strike slip	208	1.3	7.5
Newport Inglewood Connected alt 1	21.52	strike slip	208	1.3	7.5
Puente Hills (Santa Fe Springs)	23.94	thrust	11	0.7	6.7
Newport-Inglewood (Offshore)	24.77	strike slip	66	1.5	7.0
San Jose	27.42	strike slip	20	0.5	6.7
Puente Hills (LA)	34.52	thrust	22	0.7	7.0
Sierra Madre Connected	36.33	reverse	76	2	7.3
Cucamonga	37.14	thrust	28	5	6.7
Palos Verdes Connected	38.82	strike slip	285	3	7.7
Elysian Park (Upper)	39.97	reverse	20	1.3	6.7
Elsinore;T+J+CM	41.96	strike slip	169	n/a	7.6
Raymond	43.63	strike slip	22	1.5	6.5
Clamshell-Sawpit	45.44	reverse	16	0.5	6.5
Verdugo	48.48	reverse	29	0.5	6.7

(Source: https://earthquake.usgs.gov/cfusion/hazfaults_2008_search/)



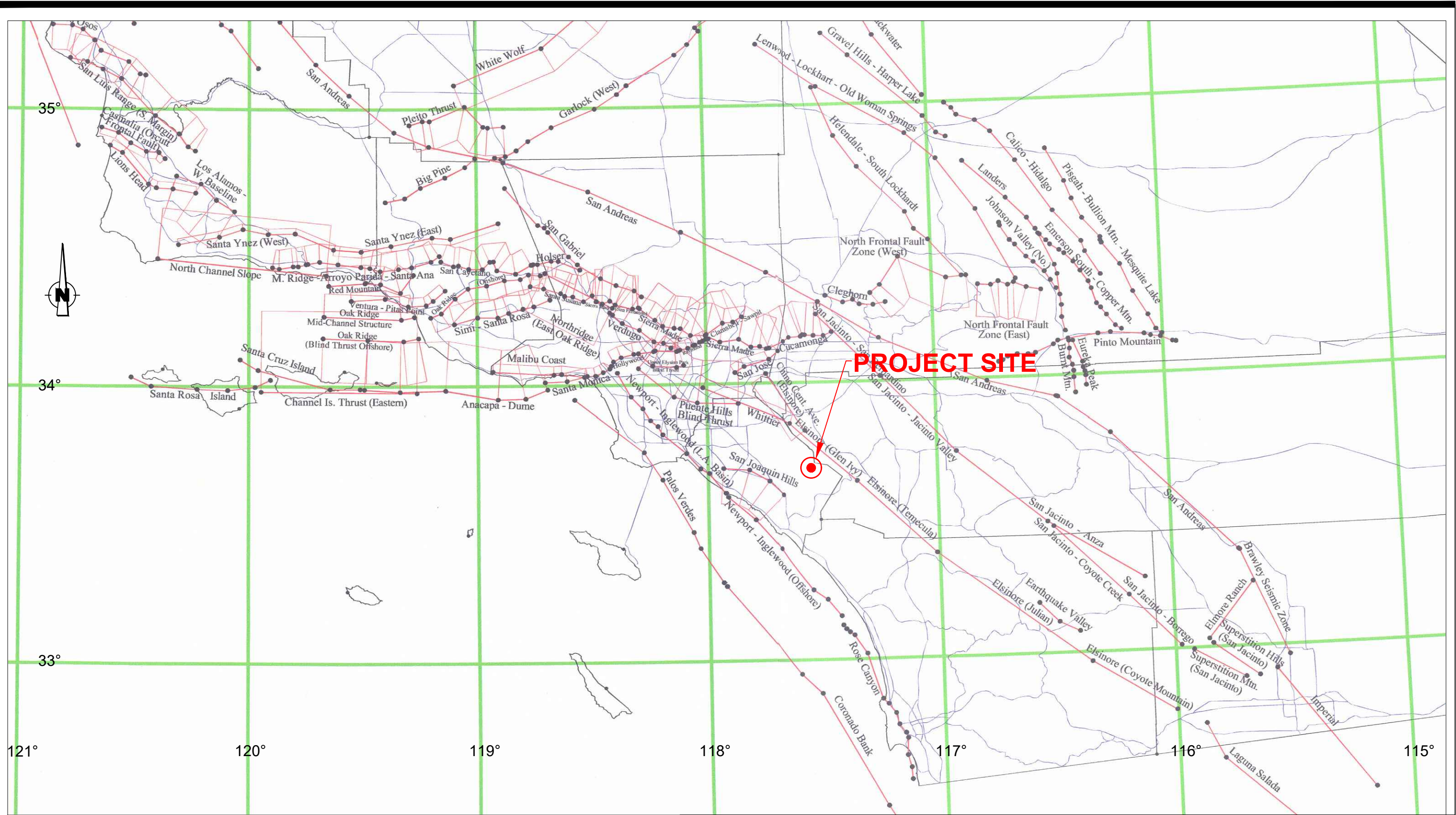

REFERENCE: PORTION OF CGS 2002 CALIFORNIA FAULT MODEL
 MODIFIED FOR USE WITH FRISKSP AND EQFAULT
 BY THOMAS F. BLAKE, AUGUST 2004

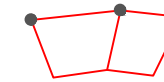
-  FAULT SOURCES
-  BLIND THRUST FAULT,
POLYGONS INDICATE RUPTURE
PLANES AND DIP DIRECTION

SOUTHERN CALIFORNIA REGIONAL FAULT MAP



Converse Consultants

OCWD PFAS Treatment Facility
Orange Park Acres Well No. 1 Wellhead Facilities
 678 N. Gravier Street
 City of Orange, California

Project No.
 20-31-172-01

Drawing NO.
 4

6.2 Historic Seismicity

We have reviewed California Geologic Survey Map Sheet 49; Epicenters and Areas Damaged by $M \geq 5$ California Earthquakes, 1800-1999, (CGS, Topozada et al., 2000). The mapped epicenters of earthquake with magnitude 5.0 or greater in Southern California during the past 200 years are shown on Drawing No. 5, *Epicenter Map of Southern California Earthquakes (1800-1999)*.

6.3 Seismic Hazard Analysis

6.3.1 Mapped Seismic Parameters

Seismic parameters based on the current edition of California Building Code (CBC, 2019) were determined using the Seismic Design Maps application (ATC, Hazards By Location Tool). The coordinates for the project site are approximately 33.7980 degrees North (latitude) and 117.81481 degrees West (longitude).

Table No. 2, 2019 CBC Mapped Seismic Parameters

Seismic Parameter	Value
Site Class	D
Mapped Spectral Accelerations for short periods, S_S	1.401 g
Mapped Spectral Accelerations for 1-sec period, S_1	0.499 g
Site Coefficient, F_a	1.0
Site Coefficient, F_v	*
⁽¹⁾ MCE_R (5%, damped) Spectral response acceleration for short periods adjusted for site class, S_{MS}	1.401 g
⁽¹⁾ MCE_R (5% damped) spectral response acceleration at 1-second period adjusted for site class, S_{M1}	*
Design spectral response acceleration (5% damped) at short periods, S_{DS}	0.934 g
Design Spectral response acceleration (5% damped) at 1-second period, S_{D1}	*
Site-Modified Peak Ground Acceleration, MCE_G PGA	0.641 g

Notes:

1. MCE_R stands for Risk-Targeted Maximum Considered Earthquake.
 2. MCE_G PGA stands for Maximum Considered Earthquake Geometric Mean Peak Ground Acceleration.
- * No value provided.

6.3.2 Site-Specific Seismic Parameters

Site-specific acceleration parameters were evaluated in accordance with the seismic provisions in Section 21 of ASCE 7-16 guidelines (ASCE, 2016), which were adopted in the 2019 California Building Code. These parameters were determined for the site coordinates and weighted average shear wave velocity from the boring data using the online calculator developed by the Utilization of Ground Motion Simulation (UGMS)



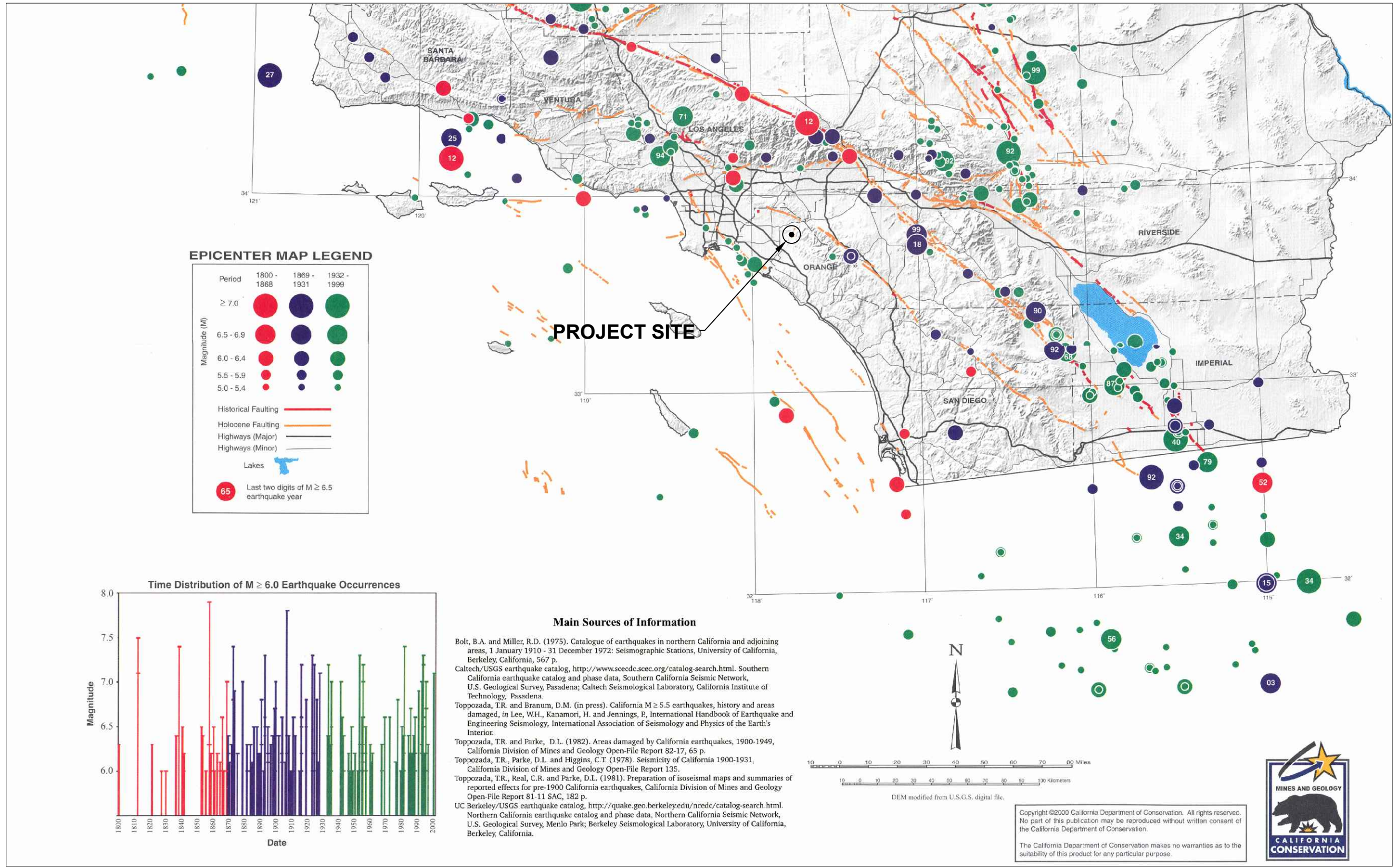

REFERENCE: PORTION OF EPICENTERS AND AREAS DAMAGED BY M≥5 CALIFORNIA EARTHQUAKES, 1800-1999 CALIFORNIA DEPARTMENT OF CONSERVATION, MAP SHEET 49 DATED 2000.

EPICENTER MAP OF SOUTHERN CALIFORNIA EARTHQUAKES (1800-1999)



OCWD PFAS Treatment Facility
 Orange Park Acres Well No. 1 Wellhead Facilities
 678 N. Gravier Street
 City of Orange, California

Project No. 20-32-172-01
 Drawing No. 5

committee of the Southern California Earthquake Center (SCEC). The recommended site-specific risk-targeted Maximum Considered Earthquake (MCE_R) and design response spectra are presented in Appendix C, *Seismic Hazard Analysis Results*. The following table summarizes the recommended 2019 CBC site-specific seismic design parameters calculated using the UGMS online tool.

Table No. 3, 2019 CBC Site-Specific Seismic Parameters

Seismic Parameter	Value
⁽¹⁾ MCE_R (5%, damped) Spectral response acceleration for short periods adjusted for site class, S_{MS}	1.832 g
⁽¹⁾ MCE_R (5% damped) spectral response acceleration at 1-second period adjusted for site class, S_{M1}	1.155 g
Design spectral response acceleration (5% damped) at short periods, S_{DS}	1.222 g
Design Spectral response acceleration (5% damped) at 1-second period, S_{D1}	0.770 g
Site-Modified Peak Ground Acceleration, MCE_G PGA	0.675 g

Site Class D was determined based on the estimated average shear wave velocity of the site in the upper 30 meters (100 feet), V_{s30} of 276.0 m/sec (906 ft/sec), which was calculated using the SPTPROP software (InfraGEO, 2020) based on the correlations with SPT blow counts by Brandenberg, Bellana and Shantz (2010). Extrapolation of estimated shear wave velocities from 50-ft depth to 100-ft depth was performed using the method proposed by Boore (2004). The Modified California Sampler blow counts were converted to equivalent SPT blow counts by multiplying the value by 0.65 to account for end-area effects.

A seismic deaggregation analysis conducted using the USGS Unified Hazard online tool shows the magnitude 7.72 event located approximately 7.26 miles (11.69 km) from the project site contributes the most to the seismic hazard at the project site.

6.4 Secondary Effects of Seismic Activity

In general, secondary effects of seismic activity include surface fault rupture, soil liquefaction, landslides, lateral spreading, and differential settlement due to seismic shaking, tsunamis, seiches, and earthquake-induced flooding. The site-specific potential for each of these seismic hazards is discussed in the following sections.

6.4.1 Surface Fault Rupture

The site is not located within a State of California Earthquake Fault Zone (CGS, 1999). Based on review of available geologic information, no major surface fault crosses through or extends towards the site. The potential for surface rupture resulting from the movement



of nearby major faults, or currently unknown faults, is not known with certainty but is considered low.

6.4.2 Liquefaction

Liquefaction is defined as the phenomenon in which a cohesionless soil mass within the upper 50 feet of the ground surface, suffers a substantial reduction in its shear strength, due to the development of excess pore pressures. During earthquakes, excess pore pressures in saturated soil deposits may develop as a result of induced cyclic shear stresses, resulting in liquefaction.

Soil liquefaction generally occurs in submerged granular soils and non-plastic silts during or after strong ground shaking. There are several general requirements for liquefaction to occur. They are as follows:

- Soils must be submerged
- Soils must be primarily granular
- Soils must be loose to medium-dense
- Ground motion must be intense
- Duration of shaking must be sufficient for the soils to lose shear resistance

The site location is located in an area designated as susceptible to liquefaction by the State of California (CGS, 1999) as shown in Drawing No. 6, *Seismic Hazard Zones Map*. Groundwater was not encountered to the maximum explored depth of 26.5 feet bgs; neither it was encountered to depth of 50 feet bgs in the 2012 geotechnical investigation by Converse; however, the historical high groundwater level at the site was reported to be between 25 and 30 feet bgs (CGS, 1997).

The site was analyzed for liquefaction and consequent seismically induced settlement using the program SPTLIQ (InfraGEO Software, 2020) and data from BH-3 from the 2012 geotechnical investigation report by Converse. We used the method of Boulanger and Idriss (2014) for liquefaction triggering. The following parameters were used in the analysis:

- Historical high groundwater level of 30 feet bgs.
- Earthquake moment magnitude of M_w of 7.72.
- Peak ground acceleration (PGA) of 0.675g, where g is the acceleration due to gravity.

Based on a site-specific liquefaction analysis presented in Appendix D, *Liquefaction and Seismic Settlement Analysis Results*, liquefaction of saturated soil at the project site is unlikely to occur. The potential for surface manifestations of liquefaction, such as sand boils and surface fissures are considered to be low.





0 1000 2000

SCALE IN FEET
SCALE: 1"=1000'

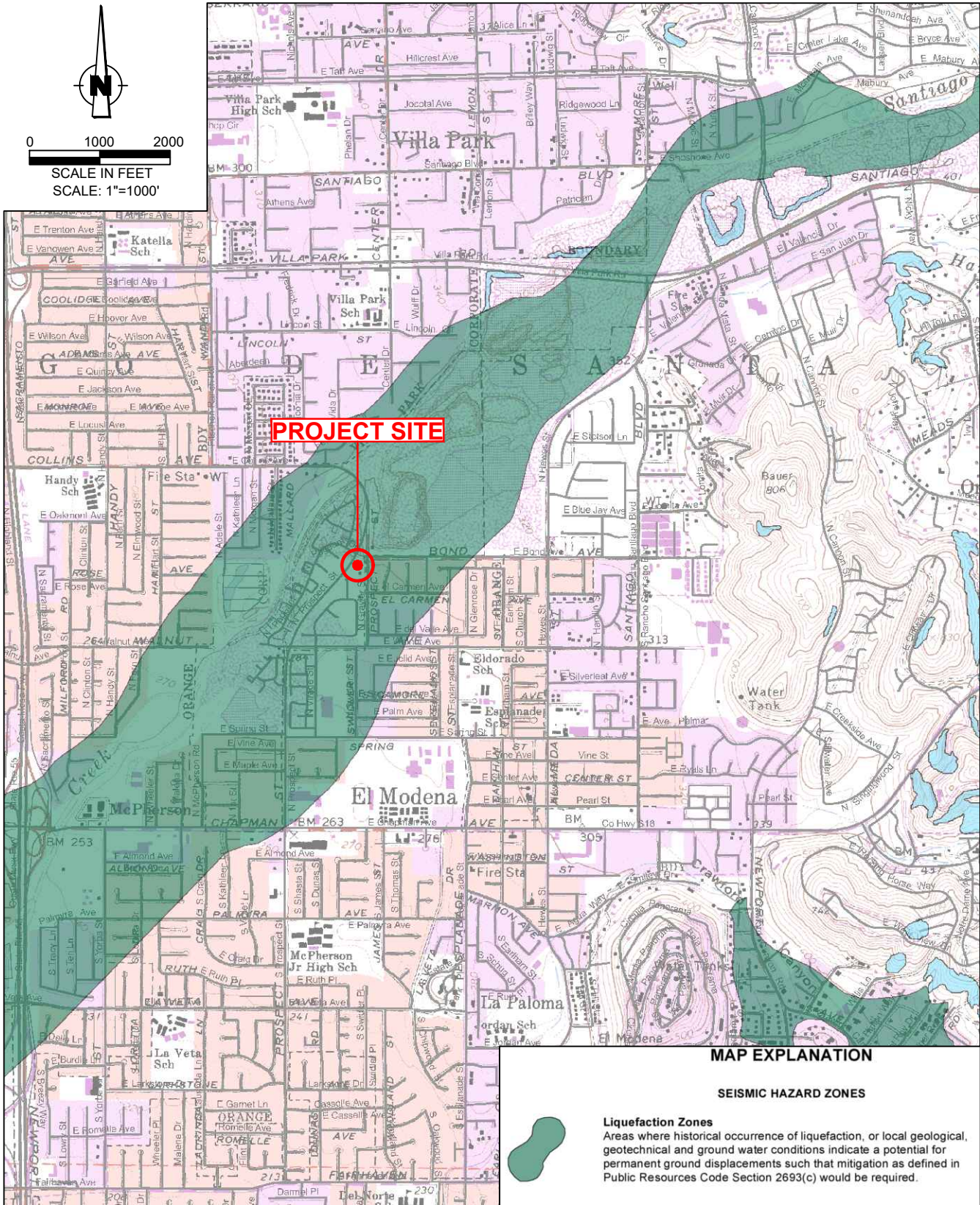

REFERENCE: ORANGE QUADRANGLE 1999
SEISMIC HAZARD ZONES STATE OF CALIFORNIA

SEISMIC HAZARD ZONES MAP



OCWD PFAS Treatment Facility
Orange Park Acres Well No. 1 Wellhead Facilities
678 N. Gravier Street
City of Orange, California

Project No.
20-31-214-01

Drawing No.
6

6.4.3 Seismic Settlement

Seismically induced ground settlement can occur with or without liquefaction which results from densification of loose soils due to strong seismic ground shaking. Seismic settlement includes both settlement of liquefied soil layers and settlement of non-liquefied, unsaturated, loose sandy sediments. We used the methods of Boulanger and Idriss (2014) using the SPT data for liquefaction triggering, Tokimatsu and Seed (1987) to estimate post-liquefaction seismic settlement, and Pradel (1998) to estimate seismic densification of dry sandy soils.

Seismically induced settlement due to densification of soil particles during ground shaking is in the order of 1.6 inches. The seismic differential settlement may be taken as equal to one-half of the total settlement over 30 horizontal feet. The results of our analysis are presented in Appendix D, *Liquefaction and Seismic Settlement Analysis Results*.

6.4.4 Lateral Spreading

Seismically induced lateral spreading involves primarily lateral movement of earth materials over underlying materials which are liquefied due to ground shaking. It differs from the slope failure in that complete ground failure involving large movement does not occur due to the relatively smaller gradient of the initial ground surface. Lateral spreading is demonstrated by near-vertical cracks with predominantly horizontal movement of the soil mass involved. Due to the relatively flat site topography, the site is not considered susceptible to lateral spreading.

6.4.5 Landslides

Seismically induced landslides and other slope failures are common occurrences during or soon after earthquakes. The site location is not located in an area designated as susceptible to landslides by the State of California (CGS, 2001). Due to the relatively flat nature of the project site, the potential for landslides is considered to be low.

6.4.6 Tsunamis

Tsunamis are large waves generated in open bodies of water by fault displacement or major ground movement. Due to the inland location of the site, tsunamis are not considered to be a risk.

6.4.7 Seiches

Seiches are large waves generated in enclosed bodies of water in response to ground shaking. Seiching in the Santiago Creek Recharge Basin, located immediately northeast of the project site, could result in site flooding.



6.4.8 Earthquake-Induced Flooding

Failure of dams or other water-retaining structures in earthquake event may result in flooding. The project site is located downstream approximately 3.6 miles from the Villa Park Dam and 7.5 miles from the Santiago Dam. Failure of either one of these dams during an earthquake may result in flooding of the project site.

7.0 LABORATORY TEST RESULTS

The physical and chemical test results are presented below.

7.1 Physical Testing

Results of the various laboratory tests are presented in Appendix B, *Laboratory Testing Program*, except for the results of *in situ* moisture and dry density tests which are presented on the Logs of Borings in Appendix A, *Field Exploration*. The results are also discussed below.

7.1.1 In-situ Moisture and Dry Density

Artificial fill

In-situ dry density and moisture content was measured for the artificial fill at a depth of 5.0 feet bgs in boring BH-2 where dry density was 117 pounds per cubic foot (pcf) and moisture content was 2 percent.

Alluvium

Results of *in-situ* moisture and dry density tests performed in accordance with ASTM Standard D2216 and D7263 are presented on the Logs of Borings in Appendix A, *Field Exploration*. Dry densities of upper 5 feet alluvium soils was 115.0 pcf with moisture contents of 3 percent at boring BH-1. Results are presented in the log of borings in Appendix A, *Field Exploration*.

7.1.2 Grain Size Analysis

One representative sample was tested to determine the relative grain size distribution in accordance with the ASTM Standard D6913. The test result is graphically presented in Drawing No. B-1, *Grain Size Distribution Result*. Based on the result, soil is classified as Poorly Graded Gravel with silt (GP-GM).

7.1.3 Atterberg Limits

One sample was tested for liquid limit and plastic limit in accordance with ASTM D4318. The plastic limit of 24 and liquid limit of 28 indicate liquid index of 4 for the sample acquired



at 20 feet bgs from boring BH-2. The soil passing sieve number 40 for this sample is classified as ML. Results are presented in Drawing No. B-2, *Atterberg Limits Test Result*.

7.1.4 Maximum Dry Density and Optimum Moisture Content

Typical moisture-density relationship test of one representative sample was tested in accordance with ASTM D1557. The test result is presented in Drawing No. B-3, *Moisture-Density Relationship Results*, in Appendix B, *Laboratory Testing Program*. The laboratory maximum dry densities was 131 pcf and the optimum moisture content was 6.7 percent.

7.1.5 Direct Shear

Two direct shear tests were performed in accordance with ASTM Standard D3080 on relatively undisturbed ring samples. The test results are presented in Drawing No. B-4, *Direct Shear Test Results* in Appendix B, *Laboratory Testing Program*.

7.1.6 Swell/Collapse

One swell/collapse test was performed on relatively undisturbed samples of the site soils, in accordance with ASTM Standard D4546. The test result is shown on Drawing No. B-5, *Swell/Collapse Test Result*, in Appendix B, *Laboratory Testing Program*.

For additional information on the subsurface conditions, see the Logs of Borings in Appendix A, *Field Exploration*.

7.2 Chemical Testing - Corrosivity Evaluation

One representative soil samples were tested to determine minimum electrical resistivity, pH, and chemical content, including soluble sulfate and chloride concentrations. The purpose of this test was to determine the corrosion potential of site soils when placed in contact with common construction materials. This test was performed by EGLab, Inc. (Arcadia, CA) in accordance with California Test Methods 643, 422, and 417. The test results are summarized below and are presented in Table No. B-1 in Appendix B, *Laboratory Testing Program*.

- The pH measurement of the sample was between 8.19.
- The sulfate content of the sample was 0.003 percent by weight.
- The chloride concentration of the sample was 210 ppm.
- The minimum electrical resistivity when saturated was 7,200 ohm-cm.

8.0 EARTHWORK RECOMMENDATIONS

Recommendations for site preparation and remedial grading and estimates of shrinkage and subsidence are provided in the following sections.



8.1 General

This section contains our general recommendations regarding earthwork and grading recommendations for the site. These recommendations are based on the results of our field exploration, laboratory testing, our experience with similar projects, and data evaluation as presented in the preceding sections. These recommendations may need to be modified based on observation of the actual field conditions during grading.

Prior to the start of any earthwork, the site should be cleared of all vegetation, grass, roots, debris, and trees (if any). If needed, existing building, foundations (if any), asphalt concrete (paving area) should be removed from the site. All materials resulting from clearing and grubbing should be removed from the site.

All underground existing utilities and appurtenances should be located at the project site. Such utilities should either be protected in-place or removed and replaced during construction as required by the project specifications. All excavations should be conducted in such a manner as not to cause loss of bearing and/or lateral support of existing structures or utilities.

The final bottom surfaces of all excavations should be observed and approved by the project geotechnical consultant prior to placing any fill. Based on these observations, removal of localized areas deeper than those documented may be required during grading. Therefore, some variations in the depth and lateral extent of excavation recommended in this report should be anticipated.

8.2 Remedial Grading

To provide uniform support for the proposed foundations, the existing soils should be over-excavated and replaced with engineered fill to a minimum depth of 3 feet below the bottom of foundations, or 5 feet below the lowest adjacent grade, whichever is deeper. The over-excavation and re-compaction should extend laterally at least 5 feet beyond the footprints of the foundations. The over-excavation and re-compaction should be deepened as needed to remove any existing fill, and any very soft or saturated soil. All undocumented fill should be removed and replaced with compacted fill. The bottom of excavation should be scarified to a depth of 8 inches and compacted to at least 90 percent of the laboratory maximum dry density as determined by ASTM D1557 test method.

Native soils below the pavement should be over-excavated and recompacted to a minimum depth of twelve (12) inches below the pavement subgrade. The bottoms of the excavations should be scarified to an additional six (6) inches below the over-excavation and recompacted to at least 90 percent of the laboratory maximum dry density. The upper 12 inches beneath pavement subgrade should be compacted to at least 95 percent of the laboratory maximum dry density. The over-excavation and re-compaction should extend to at least two (2) feet beyond the edge of the pavement.



Variations in the depths and lateral extent of over-excavations will be based on observations made by the geotechnical consultant during grading and should be anticipated. The final bottom surfaces of all excavations should be observed and approved by the project geotechnical consultant prior to placing any fill or structures. If isolated pockets of very soft, loose, or pumping subgrade are encountered, the over-excavation should be locally deepened, as needed, to expose undisturbed, firm, and unyielding soils. Over-excavation should not undermine adjacent off-site improvements or structures that are to remain and be protected in place.

If loose, soft, or yielding soil conditions are encountered at the excavation bottom, the following options can be considered:

1. Over-excavate until a firm bottom is reached.
2. Scarify or over-excavate an additional 18 inches deep, and then place at least 18-inch thick layer of compacted base material (CAB or equivalent) to bridge the soft bottom. Base material should be compacted to a minimum 95% relative compaction.
3. Over-excavate an additional 18-inches deep, and then place a layer of geotextile reinforcement (i.e., Mirafi HP570, or equivalent), place an 18-inch-thick layer of compacted base material (CAB or equivalent) to bridge the soft bottom. Base materials should be compacted to a minimum 95% relative compaction. An additional layer of geotextile reinforcement may be needed on top of the compacted base materials depending on the actual site conditions.

The actual depth of removal should be based on recommendations and observations made during grading by the project geotechnical engineer or his designated representative. Therefore, some variations in the depth and lateral extent of over-excavation recommended in this report should be anticipated.

8.3 Backfill Recommendations Behind Wall

Compaction of backfill adjacent to structural walls can produce excessive lateral pressures. Improper types and locations of compaction equipment and/or compaction techniques may damage the walls. The use of heavy compaction equipment should not be permitted within a horizontal distance of 5 feet from the wall. Backfill behind any structural walls within the recommended 5-foot zone should be compacted using lightweight construction equipment such as handheld compactors to avoid overstressing the walls. The compaction of wall backfill should be conducted in accordance with the procedure described in Section 9.5, *Compaction Fill Placement*.



8.4 Engineered Fill

No fill soils or aggregate base material should be placed until excavations and/or natural ground preparation have been observed and approved by the geotechnical consultant. The native granular soils encountered within the project site are generally considered suitable for re-use as compacted fill. Excavated soils should be processed, including removal of roots and debris, removal of oversized particles, mixed, and moisture conditioned, before placing as compacted fill. On-site soils used as fill should meet the following criteria.

- No particles larger than 3 inches in largest dimension.
- Rocks larger than 1 inch should not be placed within the upper 12 inches of subgrade soils.
- Free of all organic matter, debris, or other deleterious material.
- Expansion index of 20 or less.
- Contain less than 30 percent fines (passing #200 sieve).

Imported materials, if required, should meet the above criteria prior to being imported and used as compacted fill. Any imported fills should be tested and approved by geotechnical consultant prior to delivery to the site.

8.5 Compacted Fill Placement

All surfaces to receive structural fills should be scarified to a depth of 8 inches. The soil should be moisture conditioned to within ± 3 percent of optimum moisture content for coarse soils and 2 to 3 percent above optimum moisture content for fine soils. Fill soils should be evenly spread in horizontal lifts not exceeding 8 inches in uncompacted thickness. The scarified soils should be recompacted to at least 90 percent of the laboratory maximum dry density.

All fill placed at the site should be compacted to at least 90 percent of the laboratory maximum dry densities as determined by ASTM Standard D1557 test method unless a higher compaction is specified herein. At least the upper 12 inches of subgrade soils underneath pavements intended to support vehicle loads should be scarified, moisture conditioned, and compacted to at least 95 percent of the laboratory maximum dry density.

To reduce differential settlement, variations in the soil type, degree of compaction and thickness of the engineered fill placed underneath the foundations should be minimized.

Fill materials should not be placed, spread, or compacted during unfavorable weather conditions. When site grading is interrupted by heavy rain, filling operations should not resume until the geotechnical consultant approves the moisture and density conditions of the previously placed fill.



8.6 Shrinkage and Subsidence

The volume of excavated and recompacted soils will decrease as a result of grading. The shrinkage would depend on, among other factors, the depth of cut and/or fill, and the grading method and equipment utilized. For preliminary estimation, shrinkage factors for various units of earth material at the site may be taken as presented below.

- The shrinkage factor (defined as a percentage of soil volume reduction when moisture conditioned and compacted to the average of 92 percent relative compaction) for the upper 5 feet of soils (assumed similar in-situ dry density performed for below 5 feet soils) is estimated to range from 2 to 14 percent. An average value of 8 percent may be used for preliminary earthwork planning.
- Subsidence (defined as the settlement of native materials from the equipment load applied during grading) would depend on the construction methods including type of equipment utilized. Ground subsidence may be negligible as the site is previously graded for the existing structures and buildings.

Although these values are only approximate, they represent our best estimates of the factors to be used to calculate lost volume that may occur during grading. If more accurate shrinkage and subsidence factors are needed, it is recommended that field-testing using the actual equipment and grading techniques be conducted.

8.7 Site Drainage

Adequate positive drainage should be provided away from the structure to prevent ponding and to reduce percolation of water into structural backfill. A desirable slope for surface drainage is 2 percent in landscaped areas and one percent in paved areas. Planters and landscaped areas adjacent to the structure perimeter should be designed to minimize water infiltration into the subgrade soils. Gutters and downspouts should be installed on the roofs of the structures, and runoff should be directed to the storm drain through non-erosive devices.

9.0 DESIGN RECOMMENDATIONS

Recommendations for the design and construction of the proposed facility are presented in the following sections. The recommendations provided are based on the assumption that, in preparing the site, the above earthwork recommendations will be implemented.

9.1 Shallow Foundation Design Parameters

The proposed structures and retaining walls may be supported on continuous spread footing and/or isolated spread footings. Design of the shallow foundations, including



grade beams, should be based on the recommended parameters presented in the table below.

Table No. 4, Recommended Foundation Design Parameters

Parameter	Value
Minimum continuous spread footing width	18 inches
Minimum isolated footing width	24 inches
Minimum continuous or isolated footing depth of embedment below lowest adjacent grade	18 inches
Allowable net bearing capacity	2,500 psf

The allowable net bearing capacity is defined as the maximum allowable net bearing pressure on the ground. It is obtained by dividing the net ultimate bearing capacity by a safety factor. The ultimate bearing capacity is the bearing stress at which ground fails by shear or experiences a limiting amount of settlement at the foundation. The net ultimate bearing capacity is obtained by subtracting the total overburden pressure on a horizontal plane at the foundation level from the ultimate bearing capacity.

For the underground structures, in addition to the above total net bearing capacity, overburden pressure of the soil can be added to support footings. Overburden pressure to be added to support footings can be calculated by using a total unit weight of 60 pcf times the embedded depth. The maximum allowable bearing capacity should be limited to 4,000 psf.

The net allowable bearing values indicated above are for the dead load and frequently applied live loads and are obtained by applying a factor of safety of 3.0 to the net ultimate bearing capacity. If normal code requirements are applied for design, the above allowable bearing capacity may be increased by 33 percent for short duration loading, which will include loading induced by wind or seismic forces.

9.2 Mat Foundation Design Parameters

If mat foundations are utilized, the following recommendations should be followed.

For structural design of the mat, we recommend using a subgrade modulus that models the soil response under structure loads. The modulus of subgrade reaction (k) for design of flexible mat foundations may be estimated from the available soil compressibility data and published charts or from the following formula.

$$k = k_1 [(B+1)/2B]^2$$

Where:



k= vertical modulus of subgrade reaction for mat foundation, kips per cubic feet
 $k_1= 300$ kcf, normalized modulus of subgrade reaction for 1 square foot footing
 B= foundation width, feet

If needed for structural analysis, following parameters may be used:

E= 4.0 ksi, Young's Modulus
 $\nu = 0.33$, Poisson's Ratio

Mat foundations with a minimum width of 5 feet and embedment depth of 2 feet below ground surface may be designed for allowable net bearing capacity of 2,500 psf for mat foundations founded on compacted native soil. The allowable net bearing capacity may be increased by 500 psf for each foot of depth to the maximum of 4,000 psf. The mat should be reinforced with top and bottom steel, as appropriate, to provide structural continuity and to permit spanning of local irregularities. The mat foundations dimensions and reinforcement should be based on structural design.

9.3 Lateral Earth Pressures and Resistance to Lateral Loads

In the following subsections, the lateral earth pressures and resistance to lateral loads are estimated by using on-site native soils strength parameters obtained from laboratory testing.

9.3.1 Lateral Earth Pressures

The active earth pressure behind any buried wall or foundations depends primarily on the allowable wall movement, type of backfill materials, backfill slopes, wall or foundation inclination, surcharges, and any hydrostatic pressures. The recommended lateral earth pressures for the site are presented in the following table.

Table No. 5, Recommended Lateral Earth Pressures

Loading Conditions	Static Lateral Earth Pressure	Seismic Lateral Earth Pressure
Active earth conditions (wall is free to deflect at least 0.001 radian)	40H psf (equiv. fluid pressure)	20H psf (equiv. fluid pressure)
At-rest (wall is rigid or restrained)	60H psf (equiv. fluid pressure)	NA

Note: psf = pounds per square foot; H = wall height in feet

These pressures assume a level ground surface behind the walls or foundations for a distance greater than the wall height, no surcharge and no hydrostatic pressure. If water pressure is allowed to build up behind the walls, the earth pressures should be reduced by 50 percent and added to a full hydrostatic pressure to compute the design pressures against the walls.



A backdrain or an equivalent system of backfill drainage should be incorporated into retaining wall design. Backfill immediately behind retaining structures should be a free-draining granular material. Water should not be allowed to pond near the tops of walls. To accomplish this, the final backfill surface should be such that all water is diverted away from retaining walls.

9.3.2 Resistance to Lateral Loads

Resistance to lateral loads can be assumed to be provided by friction acting at the base of foundations and by passive earth pressure. Coefficients of friction of 0.34 between mass concrete and soil, 0.30 between formed concrete and soil, and 0.25 between steel and soil may be used. A passive earth pressure of 240 psf per foot of depth may be used for the sides of footings poured against recompacted native soils. A safety factor of 1.5 was applied in calculating passive earth pressure. The maximum value of the passive earth pressure should be limited to 2,500 psf. Due to the low overburden stress of the soil at shallow depth, the upper one foot of passive resistance should be neglected unless the soil is confined by pavement or slab.

Vertical and lateral bearing values indicated above are for the total dead loads and frequently applied live loads. If normal code requirements are applied for design, the above vertical bearing and lateral resistance values may be increased by 33 percent for short duration loading, which will include the effect of wind or seismic forces.

9.4 Settlement

The settlement due to static loading of the foundations, designed as recommended above, from structural load-induced loads is anticipated to be less than one-half (0.5) inch. Differential settlement due to structural loadings is anticipated to be less than one quarter (0.25) inches.

As discussed in Appendix D, the site has a potential for seismic settlement of 1.6 inches. The seismic differential settlement may be estimated to be up to one-half of the total settlement in horizontal span of 30 feet.

The static and seismic settlements should be considered cumulatively in the design of the onsite structures. The total static and seismic differential settlement is anticipated to be in order of one (1) inch.

9.5 Slabs-on-Grade

Slabs-on-grade should be supported on properly compacted fill. Compacted fill used to support slabs-on-grade should be placed and compacted in accordance with Section 8.5, *Compacted Fill Placement*.



Slabs-on-grade should have a minimum thickness of 6 inches for support of nominal ground-floor live loads. Minimum reinforcement for slabs-on-grade should be No. 4 reinforcing bars, spaced at 18-inches on-center each way. Structural design elements of slabs-on-grade, including but not limited to thickness, reinforcement, joint spacing of more heavily loaded slabs will be dependent upon the anticipated loading conditions and the modulus of subgrade reaction of the supporting materials and should be designed by a structural engineer.

Slabs should be designed and constructed as promulgated by the American Concrete Institute (ACI) and the Portland Cement Association (PCA). Care should be taken during concrete placement to avoid slab curling. Prior to the pour of slabs, all utility trenches should be properly backfilled and compacted.

If moisture-sensitive flooring or environments are planned, slabs-on-grade should be protected by 15-mil-thick polyethylene vapor barriers. The subgrade surface should be free of all exposed rocks or other sharp objects prior to placement of the barrier. The barrier should be overlain by 2 inches of sand, to minimize punctures and to aid in the concrete curing. At the discretion of the structure engineer, the sand layer may be eliminated. Converse does not practice in the field of moisture vapor transmission evaluation/mitigation since this does not fall under the geotechnical disciplines. Therefore, we recommend that a qualified person, such as the flooring contractor, structural engineer, and/or architect be consulted to evaluate the general and specific moisture vapor transmission paths and any impact on the proposed construction.

Subgrade for slabs-on-grade should be firm and uniform. All loose or disturbed soils including under-slabs utility trench backfill should be recompacted.

In hot weather, the contractor should take appropriate curing precautions after placement of concrete to minimize cracking or curling of the slabs. The potential for slabs cracking may be lessened by the addition of fiber mesh to the concrete and/or control of the water/cement ratio.

Concrete should be cured by protecting it against loss of moisture and rapid temperature change for at least 7 days after placement. Moist curing, waterproof paper, white polyethylene sheeting, white liquid membrane compound, or a combination thereof may be used after finishing operations have been completed. The edge of concrete slabs exposed after removal of forms should be immediately protected to provide continuous curing.



9.6 Soil Corrosivity

One (1) representative site soil samples was evaluated for corrosivity with respect to common construction materials such as concrete and steel. The test results are presented in Table No. B-1 in Appendix B, *Laboratory Testing Program*.

The sulfate contents of the sampled soils correspond to American Concrete Institute (ACI) exposure category S0 for these sulfate concentrations (ACI 318-14, Table 19.3.1.1). No concrete type restrictions are specified for exposure category S0 (ACI 318-14, Table 19.3.2.1). A minimum compressive strength of 2,500 psi is recommended.

We anticipate that concrete structures such as footings, slab, and concrete pad will be exposed to moisture from precipitation and irrigation. Based on the site locations and the results of chloride testing of the sites soils, we do not anticipate that concrete structures will be exposed to external sources of chlorides, such as deicing chemicals, salt, brackish water, or seawater. ACI specifies exposure category C1 where concrete is exposed to moisture, but not to external sources of chlorides (ACI 318-14, Table 19.3.1.1). ACI provides concrete design recommendations in ACI 318-14, Table 19.3.2.1, including a compressive strength of at least 2,500 psi and a maximum chloride content of 0.3 percent.

The measured values of the minimum electrical resistivity of the samples when saturated was 7,200 Ohm-cm for the site. This indicates that the soils tested at the site are moderately corrosive to ferrous metals in contact with the soil (Romanoff, 1957).

This is a conservative assessment based on limited sampling. Additional corrosion testing should be performed at the completion of grading or as recommended by a qualified corrosion consultant.

Converse does not practice in the area of corrosion consulting. A qualified corrosion consultant should provide appropriate corrosion mitigation measures for any ferrous metals in contact with the site soils.

9.7 Concrete Flatwork

Except as modified herein, Portland cement concrete walks, driveways, access ramps, curb and gutters should be constructed in accordance with Section 303-5, *Concrete Curbs, Walks, Gutters, Cross-Gutters, Alley Intersections, Access Ramps, and Driveways*, of the Standard Specifications for Public Works Construction (Public Works Standards, 2018).

The subgrade soils under the above structures should consist of compacted fill placed as described in this report. Prior to placement of concrete, the upper 12 inches of subgrade soils should be moisture conditioned to between within 3 percent of optimum moisture content for coarse-grained soils and 2 and 3 percent above optimum for fine-grained soils.



Concrete flatwork subjected to pedestrian loading should be at least 5.0 inches thick, or as required by the civil or structural engineer. Transverse joints should be spaced 15 feet or less and should be cut to a depth of one-fourth the slab thickness.

Positive drainage should be provided away from all driveways and sidewalks to prevent seepage of surface and/or subsurface water into the concrete base and/or subgrade.

9.8 Bearing Pressure for Anchor and Thrust Blocks

An allowable net bearing pressure of 2,500 psf may be used for anchor and thrust block design against alluvial soils. Such thrust blocks should be at least 18 inches wide.

If normal code requirements are applied for design, the above recommended bearing capacity and passive resistances may be increased by 33 percent for short duration loading such as seismic loading.

10.0 CONSTRUCTION RECOMMENDATIONS

Temporary sloped excavation and shoring design recommendations are presented in the following sections.

10.1 General

Prior to the start of construction, all existing underground utilities should be located. Such utilities should either be protected in-place or removed and replaced during construction as required by the project specifications.

Vertical braced excavations are feasible at the project site. Sloped excavations may not be feasible in locations adjacent to existing utilities, structures, or other improvements. Recommendations pertaining to temporary excavations are presented in this section.

Depending on the sequence of construction, excavations may be required near existing structures, which may require vertical side wall excavation. Where the side of the excavation is a vertical cut, it should be adequately supported by temporary shoring to protect workers and any adjacent structures.

All applicable requirements of the California Construction and General Industry Safety Orders, the Occupational Safety and Health Act, and the Construction Safety Act should be met. The soils exposed in cuts should be observed during excavation by the geotechnical consultant and the competent person designated by the contractor. If potentially unstable soil conditions are encountered, modifications of slope ratios for temporary cuts may be required.



10.2 Temporary Sloped Excavations

Based on the materials encountered in the exploratory borings, sloped temporary excavations may be constructed according to the slope ratios presented in Table No. 6, *Slope Ratios for Temporary Excavation*. Any loose utility trench backfill or other fill encountered in excavations will be less stable than the native soils. Temporary cuts encountering loose fill or loose dry sand may have to be constructed at a flatter gradient than presented in table below.

Table No. 6, Slope Ratios for Temporary Excavations

Maximum Depth of Cut (feet)	Maximum Slope Ratio* (horizontal: vertical)
0 – 4	Vertical
4 – 8	1.5:1
8+	2:1

*Slope ratio assumed to be uniform from top to toe of slope.

For steeper temporary construction slopes or deeper excavations, or unstable soil encountered during the excavation, shoring or trench shields should be provided by the contractor to protect the workers in the excavation.

Surfaces exposed in slope excavations should be kept moist but not saturated to retard raveling and sloughing during construction. Adequate provisions should be made to protect the slopes from erosion during periods of rainfall. Surcharge loads, including construction materials, should not be placed within 5 feet of the unsupported slope edge. Stockpiled soils with a height higher than 6 feet will require greater distance from trench edges.

10.3 Shoring Design

The following recommendations are provided for use by the engineer during the design of the project to determine shoring requirements. The Contractor will be responsible for the design and certification of shoring considering site-specific excavation requirements.

Temporary shoring will be required where open cut excavations will not be feasible and where there are space limitations for sloped excavations or because of nearby existing structures or facilities. Temporary shoring may consist of conventional soldier piles and lagging, or interlocking sheet pile systems. The shoring may be cantilevered or may be laterally supported by walers and cross bracing. Drilled excavations for soldier piles will require the use of drilling fluids to prevent caving and to maintain an opened hole for pile installation.

In areas where sloped excavations are not feasible, but protection of existing structures is not a concern, a trench box may be used for worker safety in lieu of shoring.



Braced shoring should be designed to support a uniform rectangular lateral earth pressure of 27 psf, based on Drawing No. 7, *Recommended Lateral Earth Pressure for Braced Excavation*.

In addition to the lateral earth pressure, surcharge pressures due to miscellaneous loads, such as soil stockpiles, vehicular traffic or construction equipment located adjacent to the shoring, should be included in the design of the shoring. A uniform lateral pressure of 100 psf should be included in the upper 10 feet of the shoring to account for normal vehicular and construction traffic within 10 feet of the trench excavation. All shoring should be designed and installed in accordance with state and federal safety regulations.

For the design of soldier piles spaced at least two diameters on-center, the passive resistance of the soils adjacent to the piles may be assumed to be 360 psf/ft of embedment depth. Soldier pile members placed in drilled holes should be properly backfilled with a sand/cement slurry or lean concrete in order to develop the required passive resistance. For sheet piles, a passive resistance of 240 psf/ft of embedment, up to a maximum of 2,500 psf, may be used.

The lagging between the soldier piles may consist of pressure-treated wood members or solid steel sheets. In our opinion, steel sheeting is expected to be more expedient than wood lagging to install. Although soldier piles and any bracing used should be designed for the full-anticipated earth pressures and surcharge pressures, the pressures on the lagging are less because of the effect of arching between the soldier piles. Accordingly, the lagging between the piles may be designed for a nominal pressure of up to a maximum of 300 psf.

All applicable requirements of the California Construction and General Industry Safety Orders, the Occupational Safety and Health Act and current amendments, and the Construction Safety Act should be met. The soils exposed in cuts should be observed during excavation by a competent person employed by the contractor. If potentially unstable soil conditions are encountered, modifications of slope ratios for temporary cuts may be required.

11.0 GEOTECHNICAL SERVICES DURING CONSTRUCTION

The project geotechnical consultant should review plans and specifications as the project design progresses. Such review is necessary to identify design elements, assumptions, or new conditions which require revisions or additions to our geotechnical recommendations.

The project geotechnical consultant should be present to observe conditions during construction. Geotechnical observation and testing should be performed as needed to



TEMPORARY BRACED EXCAVATION LATERAL EARTH PRESSURE

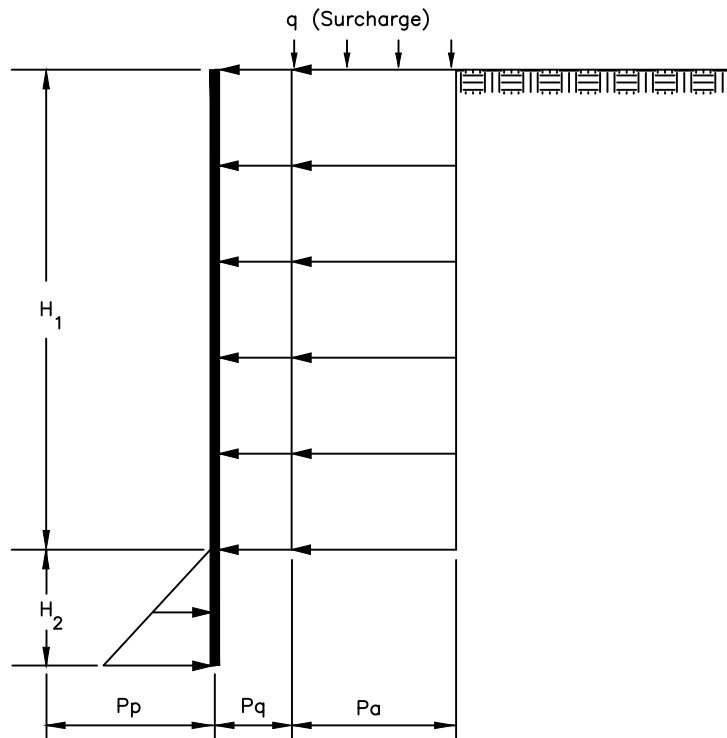

$$P = P_q + P_a$$

$$= 0.5q + 27H_1 \text{ (300 psf minimum) } - \text{ active earth pressure}$$

$$P_p = 240 H_2 \leq 2500 \text{ psf} - \text{ passive earth pressure (on native or compacted soils)}$$

$$\mu = 0.34 - \text{ allowable friction coefficient between concrete and soil}$$

Notes:

1. All values of height (H) in feet, pressure (P) and surcharge (q) in pounds per square foot (psf).
2. P_p and P_a are the passive and active earth pressure respectively; P_q is the incremental surcharge earth pressure; and μ is the allowable friction coefficient, applied to dead normal loads acting on non-pile supported elements.
3. Earth pressures assume no hydrostatic pressures. If hydrostatic pressures are allowed to build up, the incremental earth pressures below the ground-water level should be reduced by 50 percent and added to hydrostatic pressure for total lateral pressure.
4. P_p includes a safety factor of 1.5.
5. Neglect the upper 1 foot for passive pressure unless the surface is confined by a pavement of slab.
6. For traffic surcharge, use a uniform pressure of 100 psf over the top 10 feet.

RECOMMENDED LATERAL EARTH PRESSURE FOR BRACED EXCAVATION

OCWD PFAS Treatment Facility
 Orange Park Acres Well No. 1 Wellhead Facilities
 678 N. Gravier Street
 City of Orange, California

Project No.
 20-32-172-01



Converse Consultants

Drawing No.
 7

verify compliance with project specifications. Additional geotechnical recommendations may be required based on subsurface conditions encountered during construction.

12.0 CLOSURE

This report is prepared for the project described herein and is intended for use solely by AECOM, Irvine Ranch Water District (IRWD), and their authorized agents for design purposes. Our findings and recommendations were obtained in accordance with generally accepted professional principles practiced in geotechnical engineering. We make no other warranty, either expressed or implied.

Converse Consultants is not responsible or liable for any claims or damages associated with interpretation of available information provided to others. Site exploration identifies actual soil conditions only at those points where samples are taken, when they are taken. Data derived through sampling and laboratory testing is extrapolated by Converse employees who render an opinion about the overall soil conditions. Actual conditions in areas not sampled may differ. In the event that changes to the project occur, or additional, relevant information about the project is brought to our attention, the recommendations contained in this report may not be valid unless these changes and additional relevant information are reviewed and the recommendations of this report are modified or verified in writing. In addition, the recommendations can only be finalized by observing actual subsurface conditions revealed during construction. Converse cannot be held responsible for misinterpretation or changes to our recommendations made by others during construction.

As the project evolves, continued consultation and construction monitoring by a qualified geotechnical consultant should be considered an extension of geotechnical investigation services performed to date. The geotechnical consultant should review plans and specifications to verify that the recommendations presented herein have been appropriately interpreted, and that the design assumptions used in this report are valid. Where significant design changes occur, Converse may be required to augment or modify the recommendations presented herein. Subsurface conditions may differ in some locations from those encountered in the explorations, and may require additional analyses and, possibly, modified recommendations.

Design recommendations given in this report are based on the assumption that the recommendations contained in this report are implemented. Additional consultation may be prudent to interpret Converse's findings for contractors, or to possibly refine these recommendations based upon the review of the actual site conditions encountered during construction. If the scope of the project changes, if project completion is to be delayed, or if the report is to be used for another purpose, this office should be consulted.



13.0 REFERENCES

- AMERICAN CONCRETE INSTITUTE (ACI), 2014, Building Code Requirements for Structural Concrete (ACI 318-14) and Commentary, October 2014.
- AMERICAN SOCIETY OF CIVIL ENGINEERS (ASCE), 2016, Minimum Design Loads for Buildings and Other Structures, SEI/ASCE Standard No. 7-16, dated January 1, 2016.
- ASTM INTERNATIONAL, Annual Book of ASTM Standards, Current.
- BOORE, D.M., 2004, Estimating Vs(30) (or NEHRP Site Classes) from Shallow Velocity Models (Depths < 30m), Bulletin of Seismological Society of America, 94 (2), pp. 591-597.
- BOULANGER, R.W. AND IDRIS, I.M., 2014, CPT and SPT Based Liquefaction Triggering Procedures, University of California Davis, Center for Geotechnical Modeling Report No. UCD/CGM-14/01, 1-134.
- BRANDENBERG, S.J., BELLANA, N. and SHANTZ, T., 2010, Shear Wave Velocity as a Statistical Function of Standard Penetration Test Resistance and Vertical Effective Stress at Caltrans Bridge Sites, PEER Report 201/03.
- CALIFORNIA BUILDING STANDARDS COMMISSION (CBSC), 2019, California Building Code (CBC).
- CALIFORNIA DEPARTMENT OF TRANSPORTATION (Caltrans), 2017, Highway Design Manual, dated November 20, 2017.
- CALIFORNIA DEPARTMENT OF TRANSPORTATION (Caltrans), 1986, Method for Determining the Percolation Rate of Soils Using a 6-Inch-Diameter Test Hole, California Test 750, dated 1986.
- CALIFORNIA DEPARTMENT OF WATER RESOURCES (DWR), 2019, Dam Breach Inundation Map Web Publisher (https://fmds.water.ca.gov/webgis/?appid=dam_prototype_v2), accessed May 2019.
- CALIFORNIA GEOLOGICAL SURVEY (CGS), (formerly California Division of Mines and Geology), 1997, Seismic Hazard Zone Report for the Orange 7.5-minute Quadrangle, Orange County, California, Seismic Hazard Zone Report 11, dated 1997.
- CALIFORNIA GEOLOGICAL SURVEY (CGS) (formerly California Division of Mines and Geology), T. Topozada, D. Branum, M. Petersen, C. Hallstrom, C. Cramer, M. Rechle, 2000, Map Sheet 49, Epicenters of and Areas Damaged by $M \geq 5$ California Earthquakes, 1800-1999, scale varies, dated December 2000.
- CALIFORNIA GEOLOGICAL SURVEY (CGS), 2007, Fault-Rupture Hazard Zones in California, Alquist-Priolo Earthquake Faulting Zoning Act with Index to Earthquake Fault Zone Maps, Special Publication 42, revised 2007.



- CALIFORNIA GEOLOGICAL SURVEY (CGS), 2008, Guidelines for Evaluating and Mitigating Seismic Hazards in California, Special Publication 117A, dated September 11, 2008.
- CALIFORNIA GEOLOGICAL SURVEY (CGS), 2013, Note 48, Checklist for the Review of Engineering Geology and Seismology Reports for California Public Schools, Hospitals, and Essential Services Structures, dated October 2013.
- DAS, B.M., 2011, Principles of Foundation Engineering, Seventh Edition, published by Global Engineering, 2011.
- FEDERAL EMERGENCY MANAGEMENT AGENCY (FEMA), 2009, Flood Insurance Rate Map, Orange County, California and Incorporated Areas, Map No. 06059C259J, dated December 3, 2009.
- GEOTECHNICAL INVESTIGATION REPORT Orange Park Acres Well No. 1 Wellhead Facilities, Southwest of the Intersection of East Bond Avenue and North Gravier Street, City of Orange, Orange County, California. Converse Project No. 11-32-113-01, dated August 2, 2012.
- INFRAGEO SOFTWARE, 2015-2020, EPRESS: Analysis of Lateral Earth Loads and Resistance on a Retaining Wall.
- INFRAGEO SOFTWARE, 2015-2020, FTGCAP: Analysis of Bearing Capacity of a Rectangular Spread Footing.
- INFRAGEO SOFTWARE, 2015-2020, SPTLIQ: Simplified Liquefaction Hazards Assessment Using Standard Penetration Test (SPT) Data.
- INFRAGEO SOFTWARE, 2015-2020, SPTPROP: Simplified Evaluation of Site Class and Geotechnical Design Using Standard Penetration Test (SPT) Data.
- ISHIHARA, K. AND YOSHIMINE, M., 1992, Evaluation of Settlements in Sand Deposits Following Liquefaction During Earthquakes, Soils and Foundation, Japanese Geotechnical Society, 32 (1), pp. 173-188.
- MIKOLA, R.G. and SITAR, N., 2013, Seismic Earth Pressures on Retaining Structures in Cohesionless Soils, UC Berkeley Dept. of Civil and Env. Eng. Report No. UCB GT 13-01, March 2013.
- MORTON, D.M. and MILLER, F.K., 2006, Geologic Map of the San Bernardino and Santa Ana 30' x 60' Quadrangles, California, U.S. Geological Survey Open-File Report 2006-1217, scale 1:100,000.
- NINYO & MOORE, 2014, Updated Geotechnical Evaluation, Rancho Santiago Community College District, Orange Education Center Seismic Rehabilitation, dated September 16, 2014, Project No. 206144014.



ORANGE COUNTY WATERSHEDS PROGRAM (OCWP), 2013, Technical Guidance Document for the Preparation of Conceptual/Preliminary and/or Project Water Quality Management Plans, dated December 20, 2013.

PRADEL, D., 1998, Procedures to Evaluate Earthquake-Induced Settlements in Dry Sandy Soils, Journal of Geotechnical Engineering, ASCE 124 (4), pp. 364-368.

PUBLIC WORKS STANDARDS, INC., 2018, Standard Specifications for Public Works Construction (“Greenbook”), 2018.

ROMANOFF, MELVIN, 1957, Underground Corrosion, National Bureau of Standards Circular 579, dated April 1957.

UNITED STATES GEOLOGIC SURVEY, 2008 National Seismic Hazard Maps – Source Parameters, https://earthquake.usgs.gov/cfusion/hazfaults_2008_search.



GEOTECHNICAL INVESTIGATION

Appendix A

Field Exploration

APPENDIX A: FIELD EXPLORATION

Our field investigation included a site reconnaissance and a subsurface exploration program consisting of drilling soil borings. During the site reconnaissance, the surface conditions were noted, and the approximate locations of the test borings were established by reference to existing site and boundary features. The mapped locations should be considered accurate only to the degree implied by the method used to locate the borings in the field. The field exploration procedures is discussed in the following sections.

A.1 Exploratory Borings

To investigate the subsurface conditions at the project site, two (2) exploratory borings (BH-1 and BH-2) were drilled on February 25, 2021 to depth of 26.5 feet below ground surface (bgs). The approximate locations of the borings are shown on Drawing No. 2, *Boring Location Map*.

The borings were advanced using a truck-mounted drill rig equipped with 8-inch diameter hollow-stem augers for soils sampling. Encountered materials were continuously logged by a Converse geologist and classified in the field by visual classification in accordance with the Unified Soil Classification System. Where appropriate, the field descriptions and classifications have been modified to reflect laboratory test results.

Relatively undisturbed samples were obtained using California Modified Samplers (2.4 inches inside diameter and 3.0 inches outside diameter) lined with thin sample rings. The steel ring sampler was driven into the bottom of the borehole with successive drops of a 140-pound driving weight falling 30 inches. Blow counts at each sample interval are presented on the boring logs. Samples were retained in brass rings (2.4 inches inside diameter and 1.0 inch in height) and carefully sealed in waterproof plastic containers for shipment to the Converse laboratory. Bulk samples of typical soil types were also obtained.

Standard Penetration Testing (SPT) was performed in accordance with the ASTM Standard D1586 test method at 25 feet bgs in boring BH-2 using a standard (1.4 inches inside diameter and 2.0 inches outside diameter) split-barrel sampler. The mechanically driven hammer for the SPT sampler was 140 pounds, falling 30 inches for each blow. The recorded blow counts for every 6 inches for a total of 1.5 feet of sampler penetration are shown on the Logs of Borings.

The exact depths at which material changes occur cannot always be established accurately. Unless a more precise depth can be established by other means, changes in material conditions that occur between drive samples are indicated on the logs at the top of the next drive sample.



Following the completion of logging and sampling, the borings were backfilled with soil cuttings and compacted by pushing down with augers using drill rig weight. If construction is delayed, the surface may settle over time. Therefore, we recommend the owner monitor the boring locations and backfill any depressions that might occur or provide protection around the boring locations to prevent trip and fall injuries from occurring near the area of any potential settlement.

For a key to soil symbols and terminology used in the boring logs, refer to Drawing No. A-1 and A-2, *Unified Soil Classification and Key to Boring Log Symbols*. For logs of borings, see Drawing Nos. A-3 and A-4, *Logs of Borings*.



SOIL CLASSIFICATION CHART

MAJOR DIVISIONS			SYMBOLS		TYPICAL DESCRIPTIONS
			GRAPH	LETTER	
COARSE GRAINED SOILS	GRAVEL AND GRAVELLY SOILS	CLEAN GRAVELS (LITTLE OR NO FINES)		GW	WELL-GRADED GRAVELS, GRAVEL - SAND MIXTURES, LITTLE OR NO FINES
		GRAVELS WITH FINES (APPRECIABLE AMOUNT OF FINES)		GP	POORLY-GRADED GRAVELS, GRAVEL - SAND MIXTURES, LITTLE OR NO FINES
	SAND AND SANDY SOILS	CLEAN SANDS (LITTLE OR NO FINES)		GM	SILTY GRAVELS, GRAVEL - SAND - SILT MIXTURES
				GC	CLAYEY GRAVELS, GRAVEL - SAND - CLAY MIXTURES
		SANDS WITH FINES (APPRECIABLE AMOUNT OF FINES)		SW	WELL-GRADED SANDS, GRAVELLY SANDS, LITTLE OR NO FINES
				SP	POORLY-GRADED SANDS, GRAVELLY SAND, LITTLE OR NO FINES
FINE GRAINED SOILS	SILTS AND CLAYS	LIQUID LIMIT LESS THAN 50		SM	SILTY SANDS, SAND - SILT MIXTURES
				SC	CLAYEY SANDS, SAND - CLAY MIXTURES
				ML	INORGANIC SILTS AND VERY FINE SANDS, ROCK FLOUR, SILTY OR CLAYEY FINE SANDS OR CLAYEY SILTS WITH SLIGHT PLASTICITY
	SILTS AND CLAYS	LIQUID LIMIT GREATER THAN 50		CL	INORGANIC CLAYS OF LOW TO MEDIUM PLASTICITY, GRAVELLY CLAYS, SANDY CLAYS, SILTY CLAYS, LEAN CLAYS
				OL	ORGANIC SILTS AND ORGANIC SILTY CLAYS OF LOW PLASTICITY
				MH	INORGANIC SILTS, MICACEOUS OR DIATOMACEOUS FINE SAND OR SILTY SOILS
HIGHLY ORGANIC SOILS				CH	INORGANIC CLAYS OF HIGH PLASTICITY
				OH	ORGANIC CLAYS OF MEDIUM TO HIGH PLASTICITY, ORGANIC SILTS
				PT	PEAT, HUMUS, SWAMP SOILS WITH HIGH ORGANIC CONTENTS

FIELD AND LABORATORY TESTS	
C	Consolidation (ASTM D 2435)
CL	Collapse Potential (ASTM D 4546)
CP	Compaction Curve (ASTM D 1557)
CR	Corrosion, Sulfates, Chlorides (CTM 643-99; 417; 422)
CU	Consolidated Undrained Triaxial (ASTM D 4767)
DS	Direct Shear (ASTM D 3080)
EI	Expansion Index (ASTM D 4829)
M	Moisture Content (ASTM D 2216)
OC	Organic Content (ASTM D 2974)
P	Permeability (ASTM D 2434)
PA	Particle Size Analysis (ASTM D 6913 [2002])
PI	Liquid Limit, Plastic Limit, Plasticity Index (ASTM D 4318)
PL	Point Load Index (ASTM D 5731)
PM	Pressure Meter
PP	Pocket Penetrometer
R	R-Value (CTM 301)
SE	Sand Equivalent (ASTM D 2419)
SG	Specific Gravity (ASTM D 854)
SW	Swell Potential (ASTM D 4546)
TV	Pocket Torvane
UC	Unconfined Compression - Soil (ASTM D 2166)
	Unconfined Compression - Rock (ASTM D 7012)
UU	Unconsolidated Undrained Triaxial (ASTM D 2850)
UW	Unit Weight (ASTM D 2937)

NOTE: DUAL SYMBOLS ARE USED TO INDICATE BORDERLINE SOIL CLASSIFICATIONS

BORING LOG SYMBOLS

DRILLING METHOD SYMBOLS			
	Auger Drilling		Mud Rotary Drilling
	Dynamic Cone or Hand Driven		Diamond Core

SAMPLE TYPE

- STANDARD PENETRATION TEST
Split barrel sampler in accordance with ASTM D-1586-84 Standard Test Method
- DRIVE SAMPLE 2.42" I.D. sampler (CMS).
- DRIVE SAMPLE No recovery
- BULK SAMPLE
- GROUNDWATER WHILE DRILLING
- GROUNDWATER AFTER DRILLING

UNIFIED SOIL CLASSIFICATION AND KEY TO BORING LOG SYMBOLS



Converse Consultants

OCWD PFAS Treatment Facility
Orange Park Acres Well No. 1 Wellhead Facilities
678 N. Gravier Street
City of Orange, California

Project No.
20-32-172-01

Drawing No.
A-1

CONSISTENCY OF COHESIVE SOILS

Descriptor	Unconfined Compressive Strength (tsf)	SPT Blow Counts	Pocket Penetrometer (tsf)	CA Sampler	Torvane (tsf)	Field Approximation
Very Soft	<0.25	< 2	<0.25	<3	<0.12	Easily penetrated several inches by fist
Soft	0.25 - 0.50	2 - 4	0.25 - 0.50	3 - 6	0.12 - 0.25	Easily penetrated several inches by thumb
Medium Stiff	0.50 - 1.0	5 - 8	0.50 - 1.0	7 - 12	0.25 - 0.50	Can be penetrated several inches by thumb with moderate effort
Stiff	1.0 - 2.0	9 - 15	1.0 - 2.0	13 - 25	0.50 - 1.0	Readily indented by thumb but penetrated only with great effort
Very Stiff	2.0 - 4.0	16 - 30	2.0 - 4.0	26 - 50	1.0 - 2.0	Readily indented by thumbnail
Hard	>4.0	>30	>4.0	>50	>2.0	Indented by thumbnail with difficulty

APPARENT DENSITY OF COHESIONLESS SOILS

Descriptor	SPT N ₆₀ Value (blows / foot)	CA Sampler
Very Loose	<4	<5
Loose	4 - 10	5 - 12
Medium Dense	11 - 30	13 - 35
Dense	31 - 50	36 - 60
Very Dense	>50	>60

MOISTURE

Descriptor	Criteria
Dry	Absence of moisture, dusty, dry to the touch
Moist	Damp but no visible water
Wet	Visible free water, usually soil is below water table

PERCENT OF PROPORTION OF SOILS

Descriptor	Criteria
Trace (fine)/ Scattered (coarse)	Particles are present but estimated to be less than 5%
Few	5 to 10%
Little	15 to 25%
Some	30 to 45%
Mostly	50 to 100%

SOIL PARTICLE SIZE

Descriptor	Size	
Boulder	> 12 inches	
Cobble	3 to 12 inches	
Gravel	Coarse	3/4 inch to 3 inches
	Fine	No. 4 Sieve to 3/4 inch
Sand	Coarse	No. 10 Sieve to No. 4 Sieve
	Medium	No. 40 Sieve to No. 10 Sieve
	Fine	No. 200 Sieve to No. 40 Sieve
Silt and Clay	Passing No. 200 Sieve	

PLASTICITY OF FINE-GRAINED SOILS

Descriptor	Criteria
Nonplastic	A 1/8-inch thread cannot be rolled at any water content.
Low	The thread can barely be rolled, and the lump cannot be formed when drier than the plastic limit.
Medium	The thread is easy to roll, and not much time is required to reach the plastic limit; it cannot be rerolled after reaching the plastic limit. The lump crumbles when drier than the plastic limit.
High	It takes considerable time rolling and kneading to reach the plastic limit. The thread can be rerolled several times after reaching the plastic limit. The lump can be formed without crumbling when drier than the plastic limit.

CEMENTATION/ Induration

Descriptor	Criteria
Weak	Crumbles or breaks with handling or little finger pressure.
Moderate	Crumbles or breaks with considerable finger pressure.
Strong	Will not crumble or break with finger pressure.

NOTE: This legend sheet provides descriptions and associated criteria for required soil description components only. Refer to Caltrans Soil and Rock Logging, Classification, and Presentation Manual (2010), Section 2, for tables of additional soil description components and discussion of soil description and identification.

UNIFIED SOIL CLASSIFICATION AND KEY TO BORING LOG SYMBOLS



Log of Boring No. BH-1

Dates Drilled: 2/25/2021 Logged by: Karley Sullivan Checked By: Babak Abbasi

Equipment: 8" HOLLOW STEM AUGER Driving Weight and Drop: 140 lbs / 30 in

Ground Surface Elevation (ft): 290 Depth to Water (ft): NOT ENCOUNTERED

Depth (ft)	Graphic Log	SUMMARY OF SUBSURFACE CONDITIONS This log is part of the report prepared by Converse for this project and should be read together with the report. This summary applies only at the location of the boring and at the time of drilling. Subsurface conditions may differ at other locations and may change at this location with the passage of time. The data presented is a simplification of actual conditions encountered.	SAMPLES		BLOWS/6"	MOISTURE (%)	DRY UNIT WT. (pcf)	
			DRIVE	BULK				
	[Cross-hatched pattern]	0.5 INCHES OF CRUSHED ROCK		[Cross-hatched pattern]				PA (fc=6.3%) CR
	[Dotted pattern]	FILL (Af) POORLY GRADED GRAVEL WITH SILT (GP-GM): fine to coarse-grained, few cobbles up to 4 inches in largest dimension, light brown.						
5	[Dotted pattern]	ALLUVIUM (Qal): POORLY GRADED GRAVEL (GP): fine to coarse-grained, few cobbles with up to 4 inches in largest dimension, dense, grayish brown. *chatter	[Black bar]		13/22/24	3	115	
10	[Dotted pattern]	trace silt	[Black bar]		50/6"	3	99	
15	[Dotted pattern]	some cobbles with up to 5 inches in largest dimension	[Black bar]		50/26	1	115	DS
20	[Dotted pattern]	NO RECOVERY *chatter end's, fines increase			19/23/21			
25	[Dotted pattern]	SILTY SAND (SM): fine-grained, few gravels, very dense, orange brown.	[Black bar]		11/32/35	17	104	CL
		End of boring at 26.5 feet below ground surface Groundwater was not encountered Boring was backfilled with soil cuttings on 2/25/2021.						



Converse Consultants

Project Name
OCWD PFAS Treatment Facility
Orange Park Acres Well No. 1 Wellhead Facilities
678 N. Gravier Street
City of Orange, California

Project No.
20-32-172-01







Drawing No.
A-3

Log of Boring No. BH-2

Dates Drilled: 2/25/2021 Logged by: Karley Sulliva Checked By: Babak Abbasi

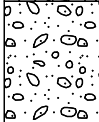
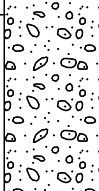
Equipment: 8" HOLLOW STEM AUGER Driving Weight and Drop: 140 lbs / 30 in

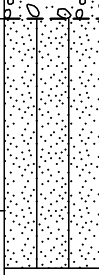
Ground Surface Elevation (ft): 290 Depth to Water (ft): NOT ENCOUNTERED

Depth (ft)	Graphic Log	SUMMARY OF SUBSURFACE CONDITIONS <small>This log is part of the report prepared by Converse for this project and should be read together with the report. This summary applies only at the location of the boring and at the time of drilling. Subsurface conditions may differ at other locations and may change at this location with the passage of time. The data presented is a simplification of actual conditions encountered.</small>	SAMPLES		BLOWS/6"	MOISTURE (%)	DRY UNIT WT. (pcf)	
			DRIVE	BULK				
5		0.5 INCHES OF CRUSHED ROCK <u>FILL (Af):</u> POORLY GRADED GRAVEL WITH SILT (GP-GM): fine to coarse-grained, few cobbles with up to 4 inches in largest dimension, light brown. *chatter				2	117	CP
10		<u>ALLUVIUM (Qal):</u> POORLY GRADED GRAVEL (GP): fine to coarse-grained, few cobbles with up to 4 inches in largest dimension, very dense, light gray-brown. heavy chatter NO RECOVERY			16/31/31			
15		NO RECOVERY no recovery due to large cobbles up to 5 inches in largest dimension			17/20/21			
20		SILTY SAND (SM): fine-grained, medium dense, orange brown.			50@1"			
25					20/16/7	11	118	DS
					4/8/24			PI
		End of boring at 26.5 feet below ground surface. Groundwater was not encountered. Boring was backfilled with soil cuttings on 2/25/2021.						



Converse Consultants

Project Name
 OCWD PFAS Treatment Facility
 Orange Park Acres Well No. 1 Wellhead Facilities
 678 N. Gravier Street
 City of Orange, California

Project No. Drawing No.
 20-32-172-01 A-4

GEOTECHNICAL INVESTIGATION

Appendix B

Laboratory Testing Program

APPENDIX B: LABORATORY TESTING PROGRAM

Tests were conducted in our laboratory on representative soil samples for the purpose of classification and evaluation of their relevant physical characteristics and engineering properties. The amount and selection of tests were based on the geotechnical requirements of the project. Summaries of the various laboratory tests conducted for this project and test results are presented below.

B.1 Moisture Content and Dry Density

In-situ dry density and moisture content tests were performed on relatively undisturbed ring samples in accordance with ASTM Standard D2216 and D7263 test method. This test is used in soil classification and provides qualitative information on strength and compressibility characteristics of site soils. For test results, see the Logs of Borings in Appendix A, *Field Exploration*.

B.2 Soil Corrosivity

one representative soil sample was tested to determine minimum electrical resistivity, pH, and chemical content, including soluble sulfate and chloride concentrations. The purpose of these tests was to determine the corrosion potential of site soils when placed in contact with common construction materials. These tests were performed by EG Lab, Inc. (Arcadia, CA) in accordance with CTM 643, 422, and 417. Test results are presented in the table below.

Table No. B-1, Summary of Soil Corrosivity Test Results

Boring No.	Depth (feet)	pH	Chloride (ppm)	Sulfate (% by weight)	Minimum Electrical Resistivity (Ohm-cm)
BH-1	0.5-3.0	8.19	210	0.003	7,200

B.3 Grain Size Analyses

To aid in classification of the soils, mechanical grain-size analysis was performed on one representative soil sample. Testing was performed in accordance with the ASTM Standard D6913 test method. For test result, see Drawing No. B-1, *Grain Size Distribution Result*.

B.4 Atterberg Limits

Atterberg limits tests were performed on one (1) sample to assist the classification of the soil and fill materials according to ASTM Standard D4318 test method. The test results are presented in the following table and on Drawing No. B-2, *Atterberg Limits Results*.



Table No. B-2 Atterberg Limit Test Results

Boring No.	Depth (feet)	Soil Classification	Liquid Limit (%)	Plastic Limit (%)	Plastic Index (%)
BH-2	25.0-26.5	Silt (ML)	28	24	4

B.5 Maximum Density and Optimum Moisture Content

Laboratory maximum dry density-optimum moisture content relationship tests were performed on one (1) representative bulk sample. The test was conducted in accordance with the ASTM Standard D1557 test method. The test results are presented in Drawing No. B-3, *Moisture-Density Relationship Results*, and are also summarized in the following table.

Table No B-3, Summary of Moisture-Density Relationship Results

Boring No.	Depth (feet)	Soil Description	Optimum Moisture (%)	Maximum Dry Density (lb/cft)
BH-2	0.0-5.0	Poorly Graded Gravel with silt (GP-GM)	6.7	131

B.6 Direct Shear

Two direct shear tests were performed on representative undisturbed soil samples in accordance with ASTM D3080. For each test, three ring samples were tested at soaked moisture conditions. The samples were placed, one at a time, directly into the test apparatus and subjected to a range of normal loads appropriate for the anticipated conditions. Depending on the soil type, each sample was then sheared at a constant strain rate between 0.004 and 0.02 inch/minute. Shear deformation was recorded until a maximum of about 0.25-inch shear displacement was achieved. Ultimate strength was selected from the shear-stress vs. deformation data and plotted to determine the shear strength parameters. For test data, including sample density and moisture content, see Drawing No. B-4, *Direct Shear Test Results*, and the summary table below.

Table No. B-4, Summary of Direct Shear Test Result

Boring No.	Depth (feet)	Soil Description	Ultimate Strength Parameters	
			Friction Angle (degrees)	Cohesion (psf)
BH-1	15.0-16.5	Poorly Graded Gravel (GP)	33	0
BH-2	20.0-21.5	Silty Sand (SM)	26	100

B.7 Collapse Tests

To evaluate the moisture sensitivity (collapse/swell potential) of the encountered soils, collapse test was performed in accordance with the ASTM Standard D4546 laboratory procedure. Sample was loaded to approximately 2 kips per square foot (ksf), allowed to



stabilize under load, and then submerged. The test results are presented in Drawing No. B-5, *Swell/Collapse Test Result*, and in the following table.

Table No. B-5, Collapse Test Result

Boring No.	Depth (feet)	Soil Classification	Percent Swell + Percent Collapse -	Collapse Potential
BH-1	25.0-26.5	Silty Sand (SM)	0.0 %	None

B.8 Sample Storage

Soil samples stored in our laboratory will be discarded 30 days after the date of this report, unless this office receives a specific request to retain the samples for a longer period.



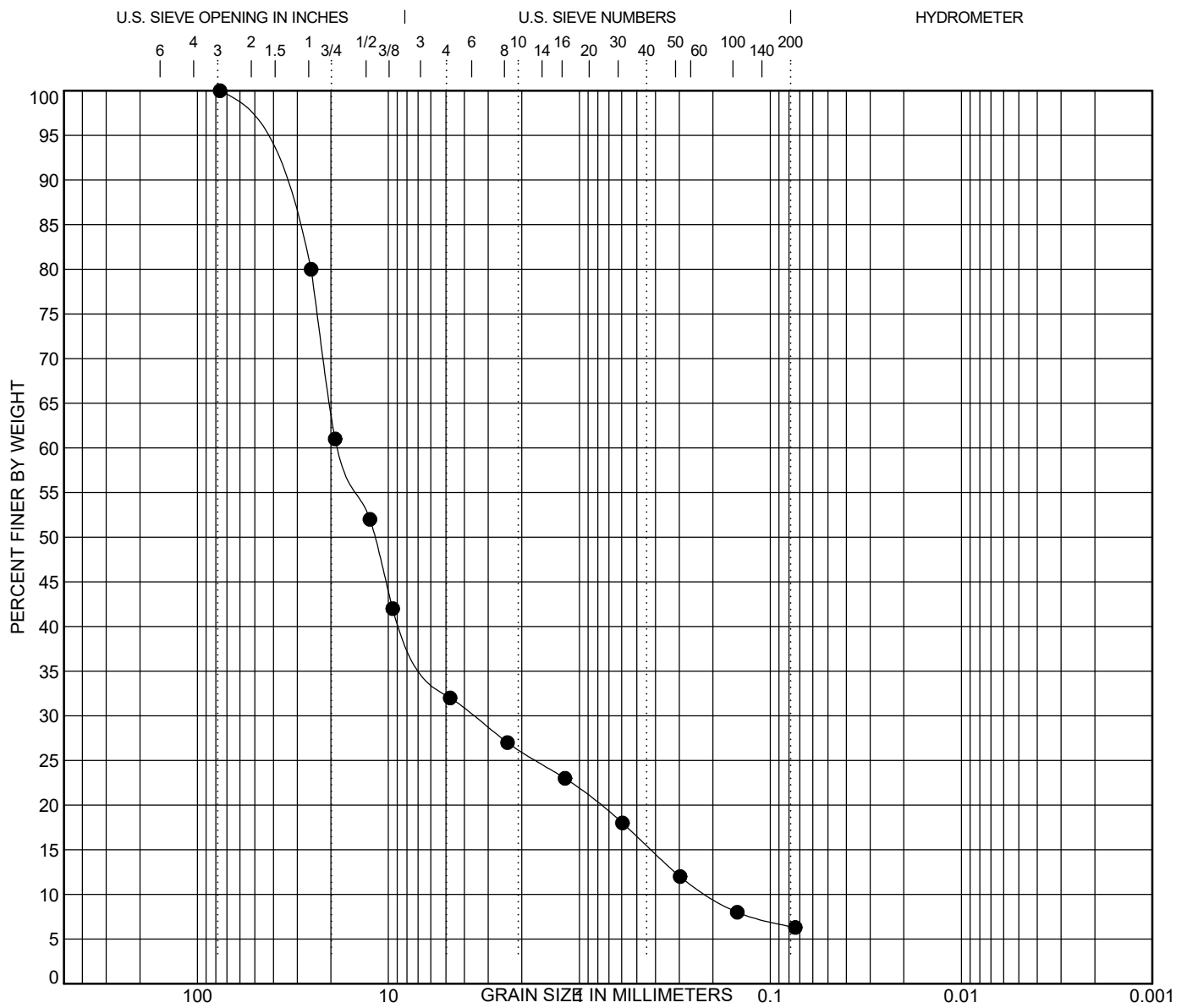

COBBLES	GRAVEL		SAND			SILT OR CLAY
	coarse	fine	coarse	medium	fine	

Boring No.	Depth (ft)	Description					LL	PL	PI	Cc	Cu
● BH-1	0.5-3.0	Poorly Graded Gravel with silt (GP-GM)								3.40	86.21
Boring No.	Depth (ft)	D100	D60	D30	D10	%Gravel	%Sand	%Silt	%Clay		
● BH-1	0.5-3.0	76.2	18.136	3.603	0.21	67.7	25.7	6.3			

GRAIN SIZE DISTRIBUTION RESULTS



Converse Consultants

Project Name
 OCWD PFAS Treatment Facility
 Orange Park Acres Well No. 1 Wellhead Facilities
 678 N. Gravier Street
 City of Orange, California

Project No.
 20-32-172-01

Figure No.

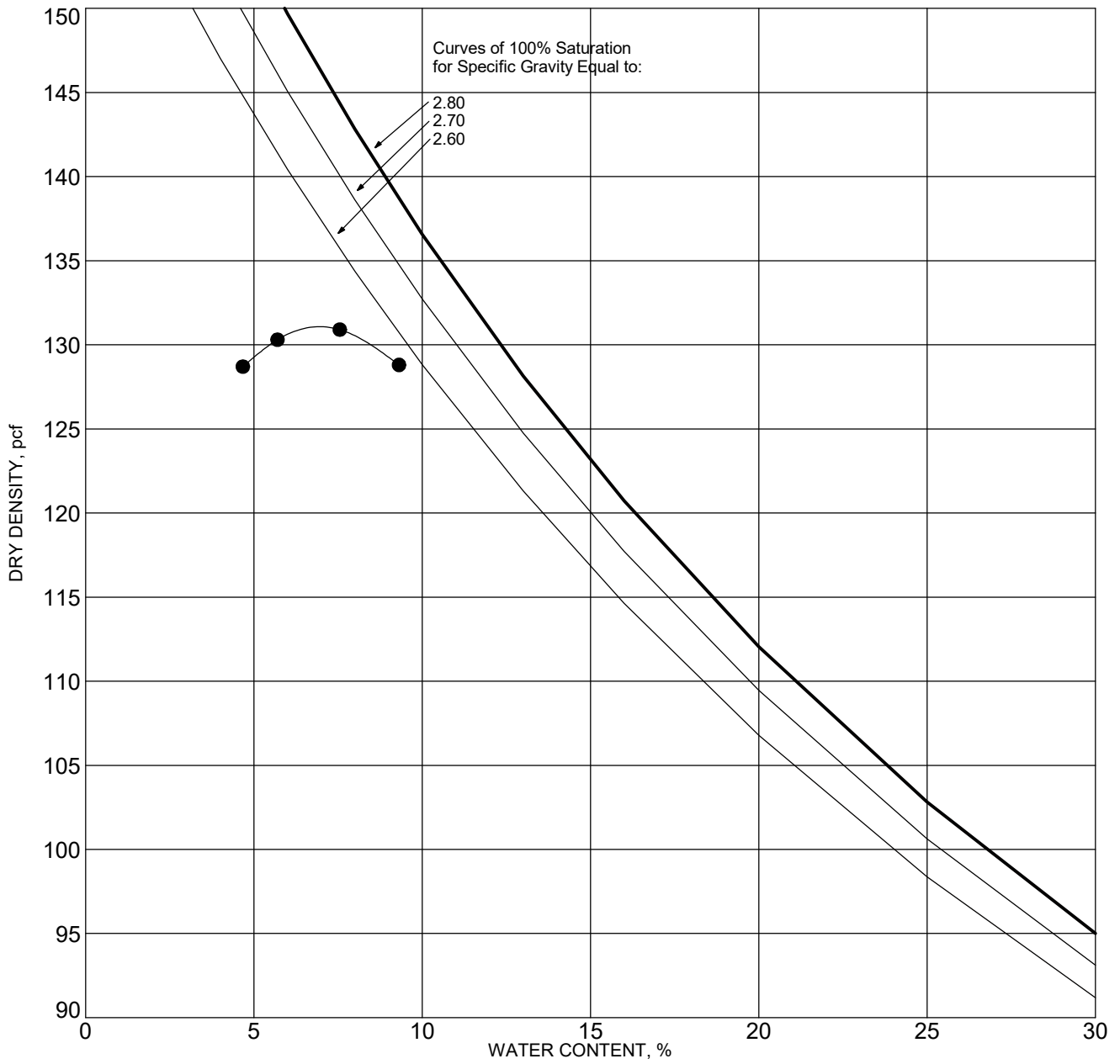

SYMBOL	BORING NO.	DEPTH (ft)	DESCRIPTION	ASTM TEST METHOD	OPTIMUM WATER, %	MAXIMUM DRY DENSITY, pcf
●	BH-2	0-5	Poorly Graded Gravel with silt (GP-GM), light brown	D1557 Method B	6.7	131

NOTE:

MOISTURE-DENSITY RELATIONSHIP RESULTS



Converse Consultants

Project Name
 OCWD PFAS Treatment Facility
 Orange Park Acres Well No. 1 Wellhead Facilities
 678 N. Gravier Street
 City of Orange, California

Project No.
 20-32-172-01

Drawing No.
 B-3

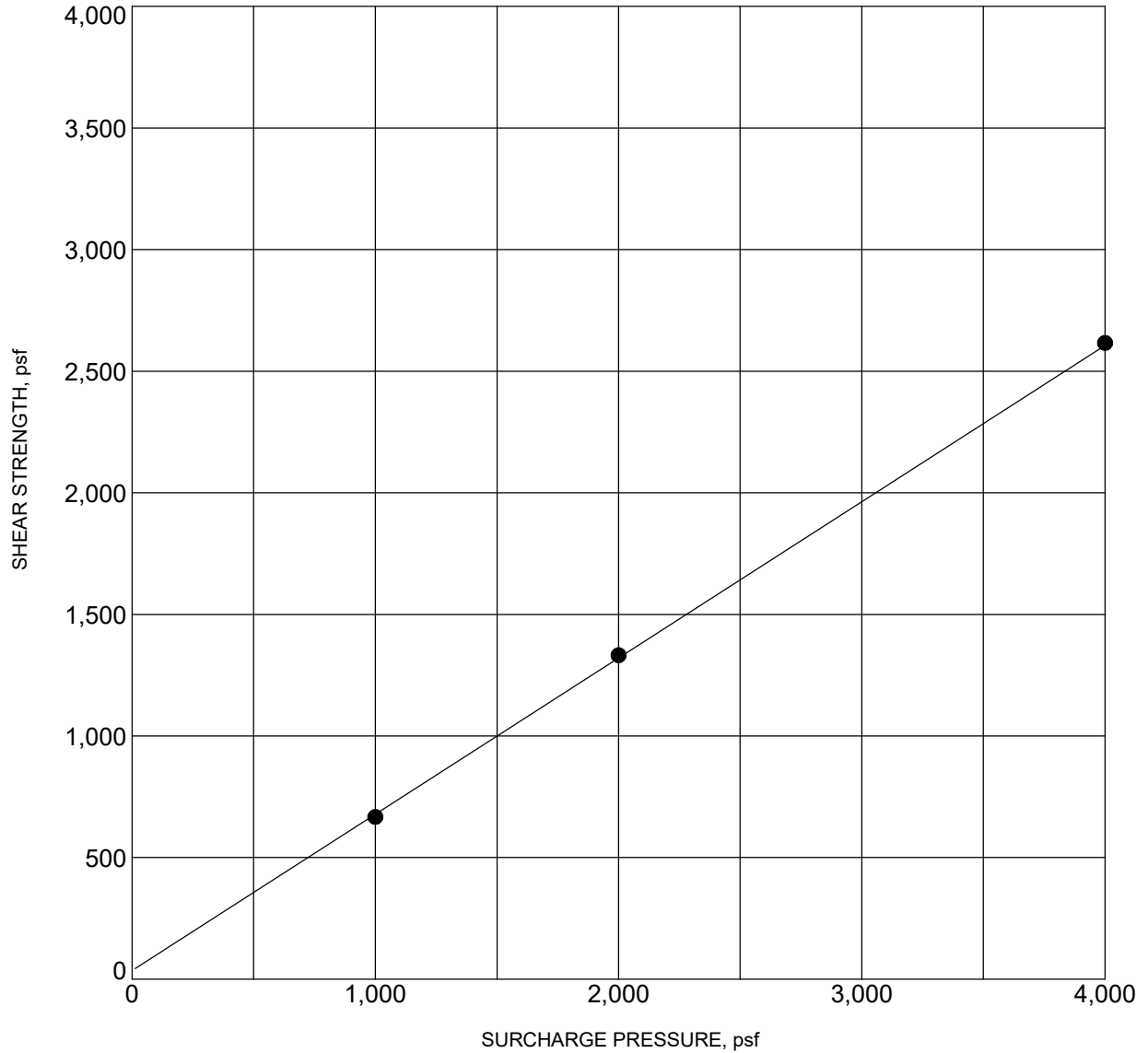

BORING NO. :	BH-1	DEPTH (ft) :	15.0-16.5
DESCRIPTION :	Poorly Graded Gravel (GP)		
COHESION (psf) :	0	FRICTION ANGLE (degrees):	33
MOISTURE CONTENT (%) :	1.0	DRY DENSITY (pcf) :	115.0

NOTE: Ultimate Strength.

DIRECT SHEAR TEST RESULTS



Converse Consultants

Project Name
 OCWD PFAS Treatment Facility
 Orange Park Acres Well No. 1 Wellhead Facilities
 678 N. Gravier Street
 City of Orange, California

Project No. Drawing No.
 20-32-172-01 B-4a

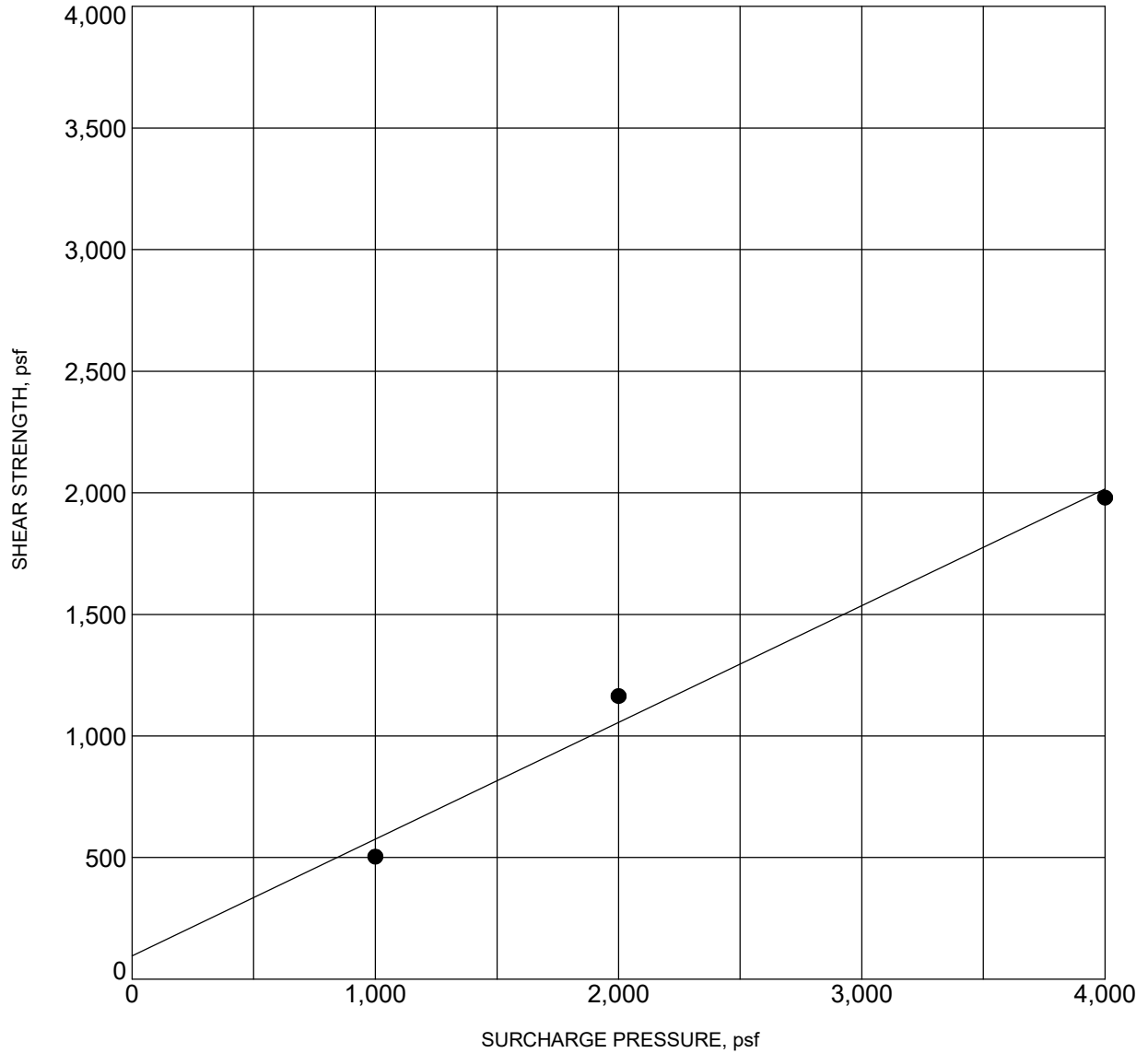

BORING NO. :	BH-2	DEPTH (ft) :	20.0-21.5
DESCRIPTION :	Silty Sand (SM)		
COHESION (psf) :	100	FRICTION ANGLE (degrees):	26
MOISTURE CONTENT (%) :	11.0	DRY DENSITY (pcf) :	118.1

NOTE: Ultimate Strength.

DIRECT SHEAR TEST RESULTS



Converse Consultants

Project Name
 OCWD PFAS Treatment Facility
 Orange Park Acres Well No. 1 Wellhead Facilities
 678 N. Gravier Street
 City of Orange, California

Project No. Drawing No.
 20-32-172-01 B4b

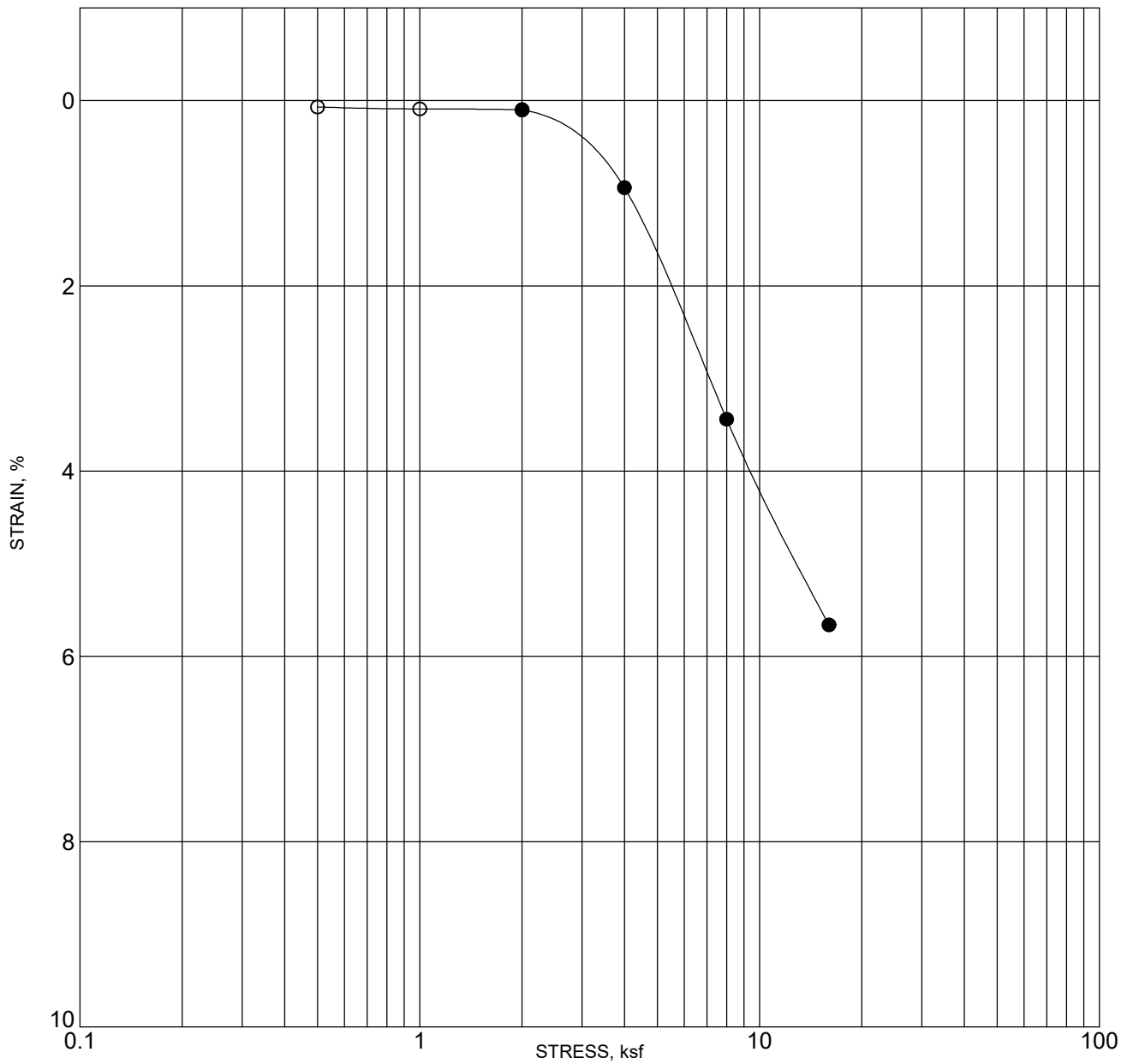

BORING NO. : BH-1		DEPTH (ft) : 25.0-26.5	
DESCRIPTION : Silty Sand (SM)			
MOISTURE CONTENT (%)	DRY DENSITY (pcf)	PERCENT SATURATION	VOID RATIO
INITIAL 17	104.0	77	0.740
FINAL			

NOTE: SOLID CIRCLES INDICATE READINGS AFTER ADDITION OF WATER

COLLAPSE/SWELL TEST RESULTS



Converse Consultants

Project Name
 OCWD PFAS Treatment Facility
 Orange Park Acres Well No. 1 Wellhead Facilities
 678 N. Gravier Street
 City of Orange, California

Project No. Drawing No.
 20-32-172-01 B-5

GEOTECHNICAL INVESTIGATION

Appendix C

Seismic Hazard Analysis Results



Site Class Determination



SIMPLIFIED EVALUATION OF SITE CLASS AND GEOTECHNICAL DESIGN PARAMETERS USING STANDARD PENETRATION TEST (SPT) DATA

(Copyright © 2015, 2020, SPTPROP, All Rights Reserved; By: InfraGEO Software)

PROJECT INFORMATION	
Project Name	OCWD PFAS Treatment Facility
Project No.	20-32-172-01
Project Location	678 N. Gravier Street, City of Orange, California
Analyzed By	B. Abbasi
Reviewed By	C. Amante
GENERAL INPUT DATA	
Analysis Description	
Boring ID No.	BH-3 (2012)
Ground Surface Elevation	294.00 feet
Proposed Grade Elevation	294.00 feet
Total Unit Weight of New Fill	120.00 pcf
Borehole Diameter	8.00 inches
Hammer Weight	140.00 pounds
Hammer Drop	30.00 inches
Hammer Efficiency Ratio, ER	80.00 %
Hammer Dist. to Ground Surface	5.00 feet
Groundwater Depth During Test	50.00 feet

SPT BLOW COUNT AND RELATIVE DENSITY
- Based on the recommendations by Idriss and Boulanger (2008), the normalized SPT blow count is defined as $(N_1)_{60} = N_{60} C_N$ where $N_{60} = N_{field} C_E C_B C_R C_S$
and the relative density of granular soils is estimated as $D_r = 15 [(N_1)_{60}]^{0.5}$ in percent

SHEAR WAVE VELOCITY AND SITE CLASSIFICATION
- Shear wave velocities are estimated based on empirical correlations with SPT N_{60} values for various soil types, as derived by Brandenberg, Bellana and Shantz (2010) from regression analyses.
- Site classification is analyzed using the method by Boore (2004). Ave. Shear Wave Velocity (Top Depth d), $V_{s,d} = 231.40 \text{ m/s}$ Ave. Shear Wave Velocity (Top 30 m), $V_{s,30} = 10^{a + b \log(V_{s,d})}$ where $a = 0.01380$ $b = 1.02630$
Coefficients a and b vary with depth, as derived by Boore (2004). Computed $V_{s,30} = 276.0 \text{ m/s}$ Site Class = D

SOIL STRENGTH AND DEFORMATION MODULUS PARAMETERS
- For granular soils, the effective peak friction angle, ϕ' , is estimated from correlations with the normalized SPT blow count, $(N_1)_{60}$ from Bowles (1996) and recommended adjustments from Caltrans Geotechnical Manual (2014).
- For cohesive soils, the undrained shear strength, S_u , is based on field measurements with torvane or pocket penetrometer. When only SPT values are available, S_u is estimated using the correlation chart with $(N_1)_{60}$ value provided in the Caltrans Geotechnical Manual (2014).
- Modulus of Elasticity, E_s , values for granular soils and cohesive soils are estimated from correlations with SPT N_{60} and undrained shear strength, S_u , respectively summarized by Bowles (1996).
- Shear Modulus, $G = E_s / [3(1 - 2\mu)]$ and Bulk Modulus, $K = E_s / [2(1 + \mu)]$ based on theory of elasticity where μ is the Poisson's ratio of the soil. Typical values of Poisson's ratio are estimated from various references.

REFERENCES:
1. AASHTO, 1988. Manual on Subsurface Investigations.
2. Boore, D.M., 2004. "Estimating Vs(30) (or NEHRP Site Classes) from shallow velocity models (depths < 30 m)", Bulletin of Seismological Society of America, 94(2), pp. 591-597.
3. Brandenberg, S.J., Bellana, N. and Shantz, T., 2010. "Shear Wave Velocity as a Statistical Function of Standard Penetration Test Resistance and Vertical Effective Stress at Caltrans Bridge Sites," PEER Report 201.03.
4. FHWA, 2002. Subsurface Investigations Reference Manual, Geotechnical Site Characterization.
5. Idriss, I.M. and Boulanger, R.W., 2008, "Soil Liquefaction During Earthquakes", EERI Monograph MNO-12.

INPUT SOIL PROFILE DATA							
Depth to Top of Soil Layer (feet)	Depth to Bottom of Soil Layer (feet)	Material Type USCS Group Symbol (ASTM D2487)	Total Soil Unit Weight γ_t (pcf)	Type of Soil Sampler	Field Blow Count N_{field} (blows/ft)	Pocket Penetrometer Shear Test Results PP (tsf)	Torvane Shear Test Results TV (tsf)
0.00	5.00	GC	124.5	MCal	11.0		
5.00	10.00	GC	124.5	SPT1	10.0		
10.00	15.00	GP	113.5	MCal	50.0		
15.00	20.00	GP	113.5	MCal	50.0		
20.00	25.00	SC	130.5	SPT1	21.0		
25.00	30.00	SC	130.5	MCal	16.0		
30.00	35.00	GC	133.0	SPT1	70.0		
35.00	40.00	GC	133.0	MCal	57.0		
40.00	45.00	SC	130.0	SPT1	5.0		
45.00	50.00	GP	135.0	MCal	80.0		

ESTIMATED GEOTECHNICAL DESIGN PARAMETERS																	
Bottom of Soil Layer Elevation (feet)	Soil Depth During Test (feet)	SPT Corr. For Vert. Stress C_N	SPT Corr. For Hammer Energy C_E	SPT Corr. For Borehole Size C_B	SPT Corr. For Rod Length C_R	SPT Corr. For Sampling Method C_S	Corrected SPT Blow Count N_{60}	Normalized SPT Blow Count $(N_1)_{60}$	Relative Density (%) D_r	Shear Wave Velocity (ft/s) V_s	Effective Peak Friction Angle (deg) ϕ'	Undrained Shear Strength (ksf) S_u	Apparent Density / Soil Consistency Description FHWA (2002) and AASHTO (1988)	Poisson's Ratio μ	Modulus of Elasticity (ksf) E_s	Shear Modulus (ksf) G	Bulk Modulus (ksf) K
289.00	2.50	1.700	1.333	1.150	0.750	0.650	8.2	14.0	56.00	433.84	33.00		Loose Gravel	0.25	1,243.67	829.11	497.47
284.00	7.50	1.464	1.333	1.150	0.800	1.000	12.3	18.0	64.00	584.26	34.00		Medium Dense Gravel	0.30	1,310.40	1,092.00	504.00
279.00	12.50	1.144	1.333	1.150	0.850	0.650	42.4	48.4	100.00	739.27	42.00		Dense Gravel	0.35	1,806.91	2,008.00	669.00
274.00	17.50	0.977	1.333	1.150	0.950	0.650	47.3	46.2	100.00	805.00	41.00		Dense Gravel	0.35	1,889.14	2,099.00	700.00
269.00	22.50	0.860	1.333	1.150	0.950	1.000	30.6	26.3	77.00	819.91	35.00		Dense Sand	0.35	585.88	651.00	217.00
264.00	27.50	0.772	1.333	1.150	0.950	0.650	15.1	11.7	51.00	806.51	31.00		Medium Dense Sand	0.30	405.29	338.00	156.00
259.00	32.50	0.706	1.333	1.150	1.000	1.000	107.3	75.7	100.00	1,015.30	43.00		Very Dense Gravel	0.40	2,879.00	4,798.00	1,028.00
254.00	37.50	0.654	1.333	1.150	1.000	0.650	56.8	37.1	91.00	990.30	38.00		Very Dense Gravel	0.40	2,045.37	3,409.00	730.00
249.00	42.50	0.612	1.333	1.150	1.000	1.000	7.7	4.7	32.00	842.82	29.00		Loose Sand	0.25	295.71	197.00	118.00
244.00	47.50	0.577	1.333	1.150	1.000	0.650	79.7	46.0	100.00	1,084.81	41.00		Very Dense Gravel	0.40	2,423.60	4,039.00	866.00

Mapped Seismic Parameters



Search Information

Coordinates: 33.79802, -117.814809
Elevation: 301 ft
Timestamp: 2021-03-23T18:05:11.283Z
Hazard Type: Seismic
Reference Document: ASCE7-16
Risk Category: III
Site Class: D

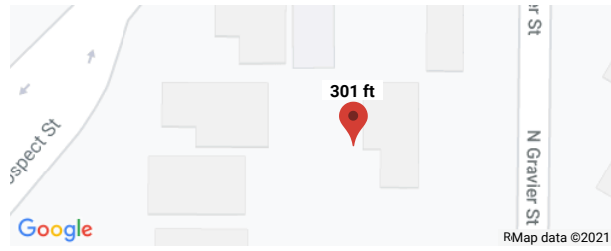

Basic Parameters

Name	Value	Description
S _S	1.401	MCE _R ground motion (period=0.2s)
S ₁	0.499	MCE _R ground motion (period=1.0s)
S _{MS}	1.401	Site-modified spectral acceleration value
S _{M1}	* null	Site-modified spectral acceleration value
S _{DS}	0.934	Numeric seismic design value at 0.2s SA
S _{D1}	* null	Numeric seismic design value at 1.0s SA

* See Section 11.4.8

Additional Information

Name	Value	Description
SDC	* null	Seismic design category
F _a	1	Site amplification factor at 0.2s
F _v	* null	Site amplification factor at 1.0s
CR _S	0.93	Coefficient of risk (0.2s)
CR ₁	0.926	Coefficient of risk (1.0s)
PGA	0.583	MCE _G peak ground acceleration
F _{PGA}	1.1	Site amplification factor at PGA
PGA _M	0.641	Site modified peak ground acceleration
T _L	8	Long-period transition period (s)
SsRT	1.401	Probabilistic risk-targeted ground motion (0.2s)
SsUH	1.507	Factored uniform-hazard spectral acceleration (2% probability of exceedance in 50 years)
SsD	1.665	Factored deterministic acceleration value (0.2s)
S1RT	0.499	Probabilistic risk-targeted ground motion (1.0s)
S1UH	0.539	Factored uniform-hazard spectral acceleration (2% probability of exceedance in 50 years)
S1D	0.6	Factored deterministic acceleration value (1.0s)
PGAd	0.677	Factored deterministic acceleration value (PGA)

* See Section 11.4.8

The results indicated here DO NOT reflect any state or local amendments to the values or any delineation lines made during the building code adoption process. Users should confirm any output obtained from this tool with the local Authority Having Jurisdiction before proceeding with design.

Disclaimer

Hazard loads are provided by the U.S. Geological Survey [Seismic Design Web Services](#).

While the information presented on this website is believed to be correct, ATC and its sponsors and contributors assume no responsibility or liability for its accuracy. The material presented in the report should not be used or relied upon for any specific application without competent examination and verification of its accuracy, suitability and applicability by engineers or other licensed professionals. ATC does not intend that the use of this information replace the sound judgment of such competent professionals, having experience and knowledge in the field of practice, nor to substitute for the standard of care required of such professionals in interpreting and applying the results of the report provided by this website. Users of the information from this website assume all liability arising from such use. Use of the output of this website does not imply approval by the governing building code bodies responsible for building code approval and interpretation for the building site described by latitude/longitude location in the report.

Seismic Hazard Deaggregation



Unified Hazard Tool

Please do not use this tool to obtain ground motion parameter values for the design code reference documents covered by the [U.S. Seismic Design Maps web tools](#) (e.g., the International Building Code and the ASCE 7 or 41 Standard). The values returned by the two applications are not identical.

^ Input

Edition Dynamic: Conterminous U.S. 2014 (update) (v4.2.0) ▼	Spectral Period Peak Ground Acceleration ▼
Latitude Decimal degrees 33.79802	Time Horizon Return period in years 2475
Longitude Decimal degrees, negative values for western longitudes -117.814809	
Site Class 259 m/s (Site class D) ▼	

Component

Total

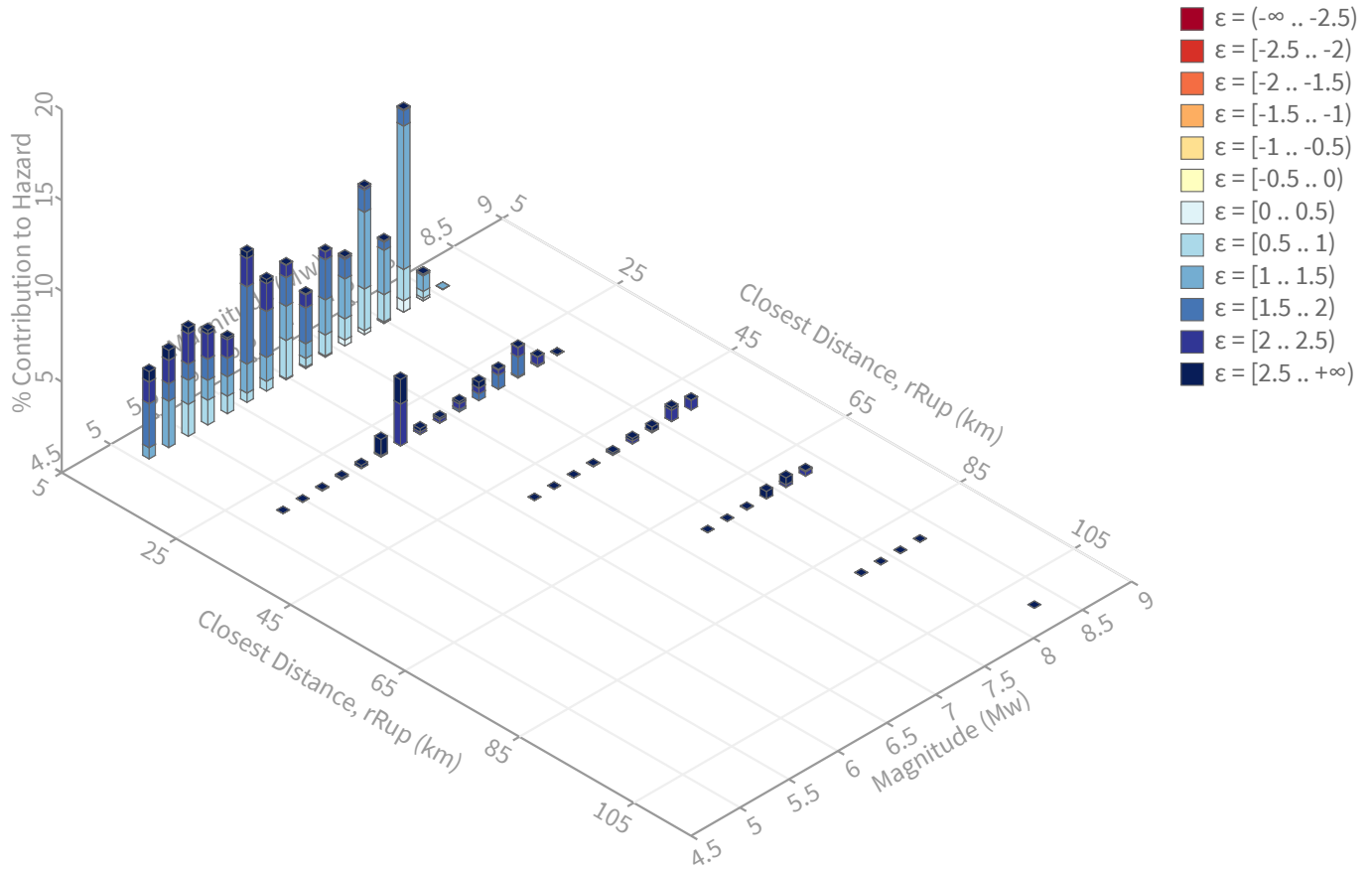

Summary statistics for, Deaggregation: Total

Deaggregation targets

Return period: 2475 yrs
Exceedance rate: 0.0004040404 yr⁻¹
PGA ground motion: 0.68455464 g

Totals

Binned: 100 %
Residual: 0 %
Trace: 0.05 %

Mode (largest m-r bin)

m: 7.72
r: 11.69 km
ε: 1.13 σ
Contribution: 11.14 %

Discretization

r: min = 0.0, max = 1000.0, Δ = 20.0 km
m: min = 4.4, max = 9.4, Δ = 0.2
ε: min = -3.0, max = 3.0, Δ = 0.5 σ

Recovered targets

Return period: 2973.518 yrs
Exceedance rate: 0.00033630198 yr⁻¹

Mean (over all sources)

m: 6.62
r: 13.64 km
ε: 1.57 σ

Mode (largest m-r-ε bin)

m: 7.72
r: 12.64 km
ε: 1.2 σ
Contribution: 7.9 %

Epsilon keys

ε0: [-∞ .. -2.5)
ε1: [-2.5 .. -2.0)
ε2: [-2.0 .. -1.5)
ε3: [-1.5 .. -1.0)
ε4: [-1.0 .. -0.5)
ε5: [-0.5 .. 0.0)
ε6: [0.0 .. 0.5)
ε7: [0.5 .. 1.0)
ε8: [1.0 .. 1.5)
ε9: [1.5 .. 2.0)
ε10: [2.0 .. 2.5)
ε11: [2.5 .. +∞]

Deaggregation Contributors

Source Set	Source	Type	r	m	ϵ_0	lon	lat	az	%
UC33brAvg_FM31		System							31.21
	Whittier alt 1 [2]		12.20	7.44	1.36	117.749°W	33.893°N	29.95	6.25
	Peralta Hills [0]		4.47	6.87	0.90	117.814°W	33.835°N	1.19	4.65
	Chino alt 1 [3]		15.06	6.72	1.81	117.662°W	33.910°N	48.45	2.85
	Compton [0]		17.25	7.23	1.18	118.043°W	33.702°N	243.35	2.46
	Elsinore (Glen Ivy) rev [0]		21.09	6.58	2.40	117.590°W	33.829°N	80.55	2.39
	San Joaquin Hills [1]		14.89	7.55	1.37	117.835°W	33.668°N	187.53	1.74
	Anaheim [0]		12.92	6.92	1.30	117.943°W	33.780°N	260.50	1.09
UC33brAvg_FM32		System							30.13
	Whittier alt 2 [2]		12.14	7.57	1.29	117.755°W	33.895°N	27.09	5.54
	Peralta Hills [0]		4.47	7.28	0.73	117.814°W	33.835°N	1.19	3.52
	Richfield [0]		10.51	6.34	1.72	117.828°W	33.886°N	352.87	2.62
	Compton [0]		17.25	7.28	1.17	118.043°W	33.702°N	243.35	2.62
	Elsinore (Glen Ivy) rev [0]		21.09	6.57	2.41	117.590°W	33.829°N	80.55	2.41
	Chino alt 2 [2]		17.72	6.98	1.79	117.652°W	33.902°N	52.51	2.11
	San Joaquin Hills [1]		14.89	7.25	1.56	117.835°W	33.668°N	187.53	1.85
	Anaheim [0]		12.92	6.98	1.25	117.943°W	33.780°N	260.50	1.12
	Yorba Linda [0]		9.19	7.54	0.81	117.860°W	33.871°N	332.45	1.04
UC33brAvg_FM32 (opt)		Grid							19.48
	PointSourceFinite: -117.815, 33.812		5.25	5.60	1.19	117.815°W	33.812°N	0.00	4.21
	PointSourceFinite: -117.815, 33.812		5.25	5.60	1.19	117.815°W	33.812°N	0.00	4.21
	PointSourceFinite: -117.815, 33.892		10.40	5.97	1.79	117.815°W	33.892°N	0.00	1.64
	PointSourceFinite: -117.815, 33.892		10.40	5.97	1.79	117.815°W	33.892°N	0.00	1.64
	PointSourceFinite: -117.815, 33.865		8.41	5.86	1.59	117.815°W	33.865°N	0.00	1.53
	PointSourceFinite: -117.815, 33.865		8.41	5.86	1.59	117.815°W	33.865°N	0.00	1.53
UC33brAvg_FM31 (opt)		Grid							19.18
	PointSourceFinite: -117.815, 33.812		5.25	5.60	1.19	117.815°W	33.812°N	0.00	4.08
	PointSourceFinite: -117.815, 33.812		5.25	5.60	1.19	117.815°W	33.812°N	0.00	4.08
	PointSourceFinite: -117.815, 33.892		10.37	5.98	1.78	117.815°W	33.892°N	0.00	1.69
	PointSourceFinite: -117.815, 33.892		10.37	5.98	1.78	117.815°W	33.892°N	0.00	1.69
	PointSourceFinite: -117.815, 33.865		8.40	5.86	1.58	117.815°W	33.865°N	0.00	1.58
	PointSourceFinite: -117.815, 33.865		8.40	5.86	1.58	117.815°W	33.865°N	0.00	1.58

Site-Specific Spectral Accelerations



Site-Specific MCE_R & Design Response Spectral Accelerations OCWD PFAS Treatment Facility

Input Parameters

Coordinates 33.798, -117.815

Site Class D - Stiff Soil

Values used in Computation

V_{S30} 274 m/s

Z1.0 350 m

Z2.5 2050 m

Calculated Results

Site-Specific Design Parameters

S_{DS} 1.222 S_{MS} 1.832

S_{D1} 0.770 S_{M1} 1.155

MCE_G Peak Ground Acceleration (Sect. 21.5)

PGA_M 0.675 g



MCE_R Response Spectra

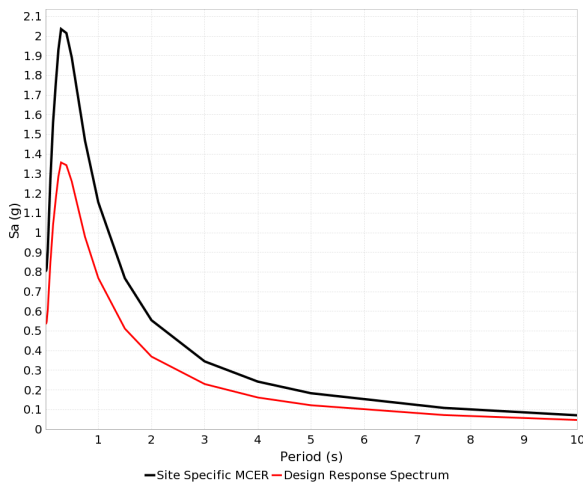

MCE_R Response Spectra Comparison

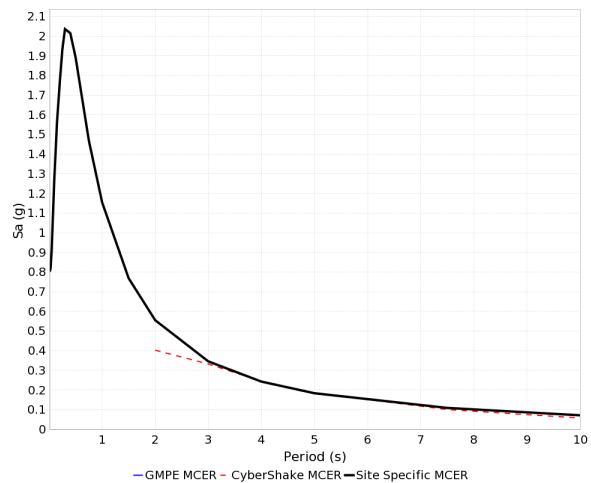

Site-Specific MCE_R & Design Response Spectral Accelerations

MCE_R Response Spectrum Table

Period (s)	GMPE Sa (g)	CyberShake Sa (g)	Site-Specific MCE_R Sa* (g)
0.01	0.805		0.805
0.02	0.808		0.808
0.03	0.821		0.821
0.05	0.912		0.912
0.075	1.097		1.097
0.1	1.276		1.276
0.15	1.562		1.562
0.2	1.756		1.756
0.25	1.930		1.930
0.3	2.036		2.036
0.4	2.016		2.016
0.5	1.893		1.893
0.75	1.469		1.469
1.0	1.155		1.155
1.5	0.768		0.768
2.0	0.555	0.403	0.555
3.0	0.346	0.332	0.346
4.0	0.242	0.244	0.243
5.0	0.182	0.185	0.184
7.5	0.109	0.101	0.109
10.0	0.071	0.058	0.071

* Site-Specific MCE_R response spectrum obtained using obtained weighted geometric averaging procedure. See User Guide: https://data2.scec.org/ugms-mcerGM-tool_v18.4/guide

Site-Specific MCE_R & Design Response Spectral Accelerations

Important Note

The site-specific, design response spectral acceleration, S_a , returned by this tool for user-specified inputs, must be compared to the minimum S_a requirement described in Section 21.3 of ASCE 7-16 (second and third paragraphs). This minimum S_a is computed as 80% of the design response spectrum derived from the SDS, SD1, and TL values obtained from the ASCE tool at <https://asce7hazardtool.online/>. The larger of the site-specific S_a and the 80% minimum S_a at each period, T , is the final design response spectral acceleration. This final $S_a \times 1.5$ is the final MCE_R response spectral acceleration.

About UGMS

The UGMS MCE_R tool was developed by the SCEC Committee for Utilization of Ground Motion Simulations (or "UGMS Committee") from research supported by the Southern California Earthquake Center (SCEC). SCEC is funded by NSF Cooperative Agreement EAR-1033462 & USGS Cooperative Agreement G12AC20038. For more information on the UGMS Committee, visit <https://www.scec.org/research/ugms>.

GEOTECHNICAL INVESTIGATION

Appendix D

Liquefaction and Seismic Settlement Analysis Results



SIMPLIFIED LIQUEFACTION HAZARDS ASSESSMENT USING STANDARD PENETRATION TEST (SPT) DATA

(Copyright © 2015, 2020, SPTLIQ, All Rights Reserved; By: InfraGEO Software)

PROJECT INFORMATION	
Project Name	OCWD PFAS Treatment Facility
Project No.	20-32-172-01
Project Location	City of Orange, California
Analyzed By	B. Abbasi
Reviewed By	C. Amante

TOPOGRAPHIC CONDITIONS	
Ground Slope, S	N/A
Free Face (L/H) Ratio	5.00 H = 20.00 feet

GROUNDWATER DATA	
GWL Depth Measured During Test	50.00 feet
GWL Depth Used in Design	30.00 feet

BORING DATA	
Boring No.	BH-3
Ground Surface Elevation	297.00 feet
Proposed Grade Elevation	297.00 feet
Borehole Diameter	8.00 inches
Hammer Weight	140.00 pounds
Hammer Drop	30.00 inches
Hammer Energy Efficiency Ratio, ER	80.00 %
Hammer Distance to Ground Surface	5.00 feet

SEISMIC DESIGN PARAMETERS	
Earthquake Moment Magnitude, M_w	7.72
Peak Ground Acceleration, A_{max}	0.68 g
Factor of Safety Against Liquefaction, FS	1.30

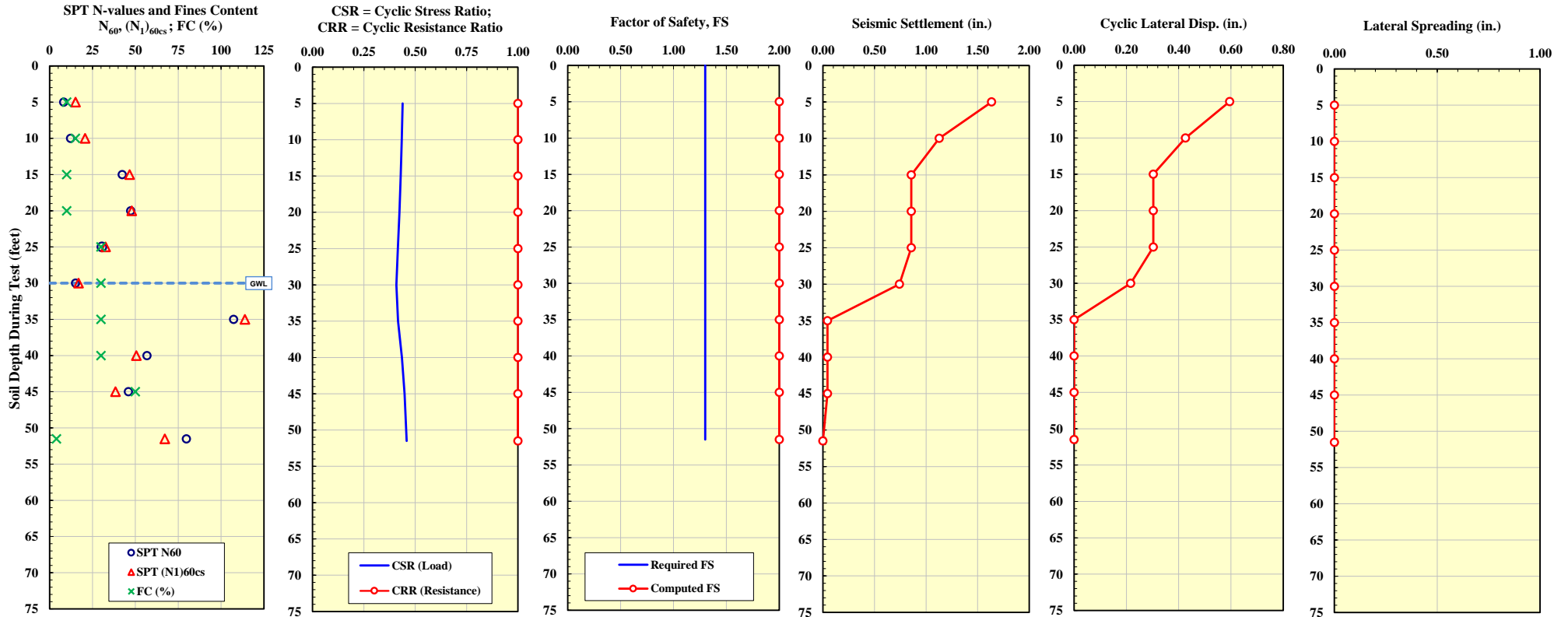

Analysis Methods Used ==>>

Liquefaction Triggering:
Boulanger-Idriss (2014)

Seismic Settlements:
Above GWL: Pradel (1998)
Below GWL: Tokimatsu and Seed (1987)

Cyclic Lateral Displacements:
Above GWL: Pradel (1998)
Below GWL: Tokimatsu and Asaka (1998)

Lateral Spreading:
Idriss and Boulanger (2008)

Appendix D: Well Pump Cut Sheet

Alternative 2 Pump Curve



Pump size & type / Stages : 15EMM / 5
 Based on curve no. : EC-2377
 Impeller diameter : 11.44 in

Customer : AECOM
 Item number : IRWD PFAS OPA-1 Revision 4
 Service : Orange Park Acres
 Flowserve reference : 3134504635
 Date : May 19, 2021

Capacity : 2,000.0 USgpm
 Head : 486.33 ft
 Density / Specific gravity : - / 0.999
 Pump speed : 1,775 rpm
 Ns / Nss : 1,519 / 9,100 (US units)
 Test tolerance : ANSI/HI 14.6 Grade 1U

CURVES ARE APPROXIMATE, PUMP IS GUARANTEED FOR ONE SET OF CONDITIONS; CAPACITY, HEAD, AND EFFICIENCY.

Bowl performance shown below is corrected for materials, viscosity and construction.

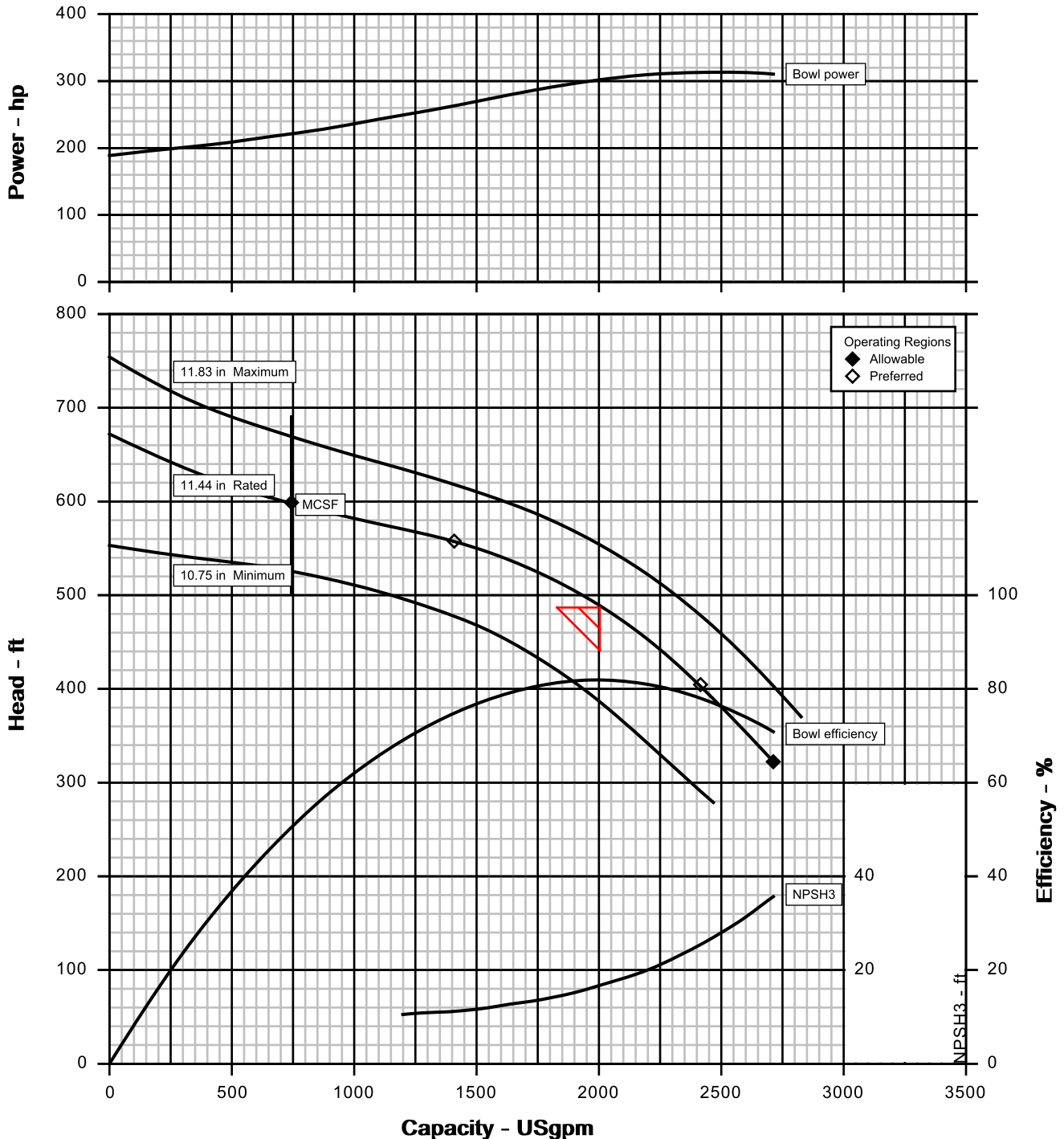

Bowl head of 491.66 ft corresponds with 486.33 ft head at low liquid level adjusted for elevation and friction losses.

Customer	: AECOM	Pump / Stages	: 15EMM	/ 5
Customer reference	: AECOM	Based on curve no.	: EC-2377	
Item number	: IRWD PFAS OPA-1 Revision 4	Flowserve reference	: 3134504635	
Service	: Orange Park Acres	Date	: May 19, 2021	

Operating Conditions		Materials / Specification	
Capacity	: 2,000.0 USgpm	Material column code	: B30
Water capacity (CQ=1.00)	: -	Other Requirements Hydraulic selection : No specification Construction : No specification Test tolerance : ANSI/HI 14.6 Grade 1U Driver Sizing : Max Power (SO to EOC) not using SF Seal configuration : Packing	
Normal capacity	: -		
Rated head @ Low liquid level	: 486.33 ft		
Water head (CH=1.00)	: -		
NPSH available (NPSHa) @ Low liquid level	: 73.8 ft		
NPSHa less NPSH margin @ Impeller eye	: -		
Maximum suction pressure	: Not applicable		
Rated suction pressure	: Not applicable		

Liquid	
Liquid type	: Other
Liquid description	: Potable Water
Temperature / Specific gravity	: 60 °F / 0.999
Viscosity / Vapor pressure	: 1.00 cSt / 0.26 psia

Performance			
Pump speed	: 1,775 rpm	Impeller diameter	: Rated / Maximum / Minimum
NPSH required (NPSH3) @ Impeller eye	: 16.5 ft		: 11.44 in / 11.83 in / 10.75 in
Minimum submergence	: 32.00 in	Impeller diameter ratio (rated/max)	: 96.7 %
Hydraulic power	: 245 hp	Maximum head at rated diameter	: 671.76 ft
Efficiency (Pump overall / Bowl) (CE=1.00)	: 79.8 % / 82.2 %	Head rise to shut off	: 36.6 %
Power (rated/max)	: 307 hp / 319 hp	Total head ratio (rated / max) / (max / rated)	: 88.5 % / 113.0 %
Driver power rating	: 350 hp / 261 kW	Flow at BEP	: 2,015.4 USgpm
Bowl pressure	: 290.5 psig	Flow as % of BEP	: 99.2 %
(based on shut off @ cut dia/rated SG)		Minimum continuous flow	: 748.0 USgpm
Maximum allowable	: 375.0 psig	Rated thrust (at Rated flow)	: 7,694.8 lbf
Bowl & column hydrotest	: 363.2 psig	Maximum thrust (at Shut off flow)	: 8,976.1 lbf
Dischg Head Dischg Region MAWP	: 285.0 psig	Min thrust - Runout flow / Max Suction	: 6,129.5 lbf
Ns / Nss	: 1,519 / 9,100 (US units)	(A negative thrust value indicates an upthrust condition)	

CURVES ARE APPROXIMATE, PUMP IS GUARANTEED FOR ONE SET OF CONDITIONS; CAPACITY, HEAD, AND EFFICIENCY.

Bowl performance shown below is corrected for materials, viscosity and construction.

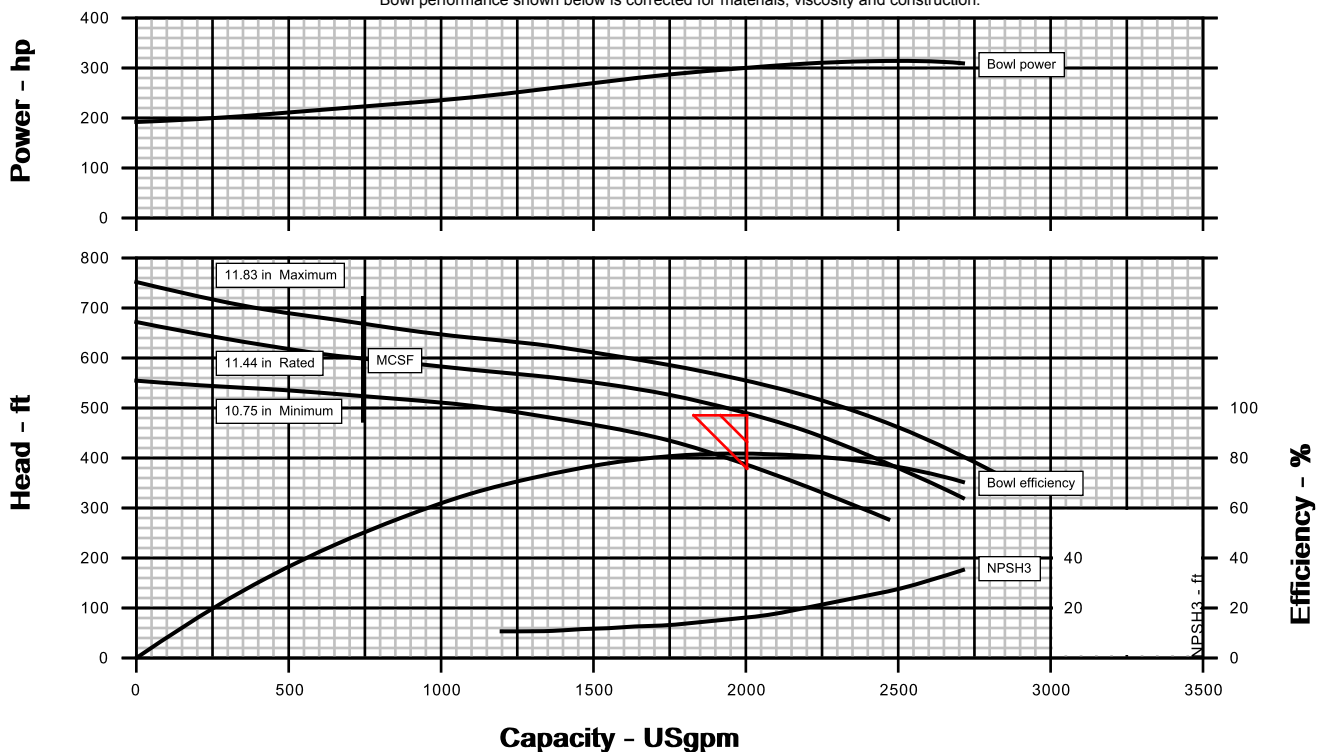

Bowl head of 491.66 ft corresponds with 486.33 ft head at low liquid level adjusted for elevation and friction losses.
 ** denotes rejection criteria

Customer	: AECOM	Pump / Stages	: 15EMM / 5
Customer reference	: AECOM	Based on curve no.	: EC-2377
Item number	: IRWD PFAS OPA-1 Revision 4	Flowserve reference	: 3134504635
Service	: Orange Park Acres	Date	: May 19, 2021
Construction		Driver Information	
Bowl construction / lined	: Flanged - Std Wall / Lined bowls	Manufacturer	: (To be determined)
Impeller type	: Enclosed	Power / SF (Req' / Act')	: 350 hp / 261 kW / 1.15 / 1.0
Impeller fastening	: Colleted	Vertical shaft type	: Hollow
Suction strainer	: Cone Strainer	Hollow shaft coupling	
Column construction	: Flanged	Driver type	: NEMA Electric Motor
Column flange spec'n	: Taneytown Specification	Frame size / Base dia	: -
Column dia (nominal)	: 12.00 in	Enclosure	: TEFC
Column pipe length	: 385.42 ft	Duty type	
Column section length	: 120.00 in	Efficiency type	
Lineshaft brg spacing	: 60.00 in	Hazardous area class	: -
Lineshaft diameter	: 1.69 in	Explosion 'T' rating	: -
Lineshaft coupling type	: Threaded coupling	Volts / Phase / Hz	: TBD / TBD / TBD
Lineshaft bearings, qty	: 78	Amps-full load/locked rotor	: - / -
Lineshaft construction	: Enclosed	Motor starting	: Direct on line (DOL)
Lineshaft lubrication	: Water	Insulation	: -
Enclosing tube diameter	: 2.88 in	Temperature rise	: -
Disch size/rating/face	: 12 in / 150 lb ANSI / RF	Bearings / Lubrication	: - / -
Pump/driver coupling	: No rigid coupling required	Motor mounted by	: Customer
"LF" - Fabricated / Above Grade Discharge / ANSI Base		Motor Thrust rating down/up	: - / -
Materials		Seal Information	
Bowl	: Cast Iron A48 CL30	Arrangement	: Encl LS Water Inj Packing
Impeller	: 316LSS A743 GR CF-3M	Size	: -
Bowl bearing	: Rubber Buna-N	Manufacturer / Type	: - / Packing
Bowl shaft	: 17-4PH A564 Gr 630	Material code (Man'f/API)	: Graphite Fiberglass / -
Bowl wear ring	: 12%Chrome A743-CA6NM	Gland material	: Cast iron
Impeller wear ring	: 12%Chrome A743-CA6NM	Auxiliary seal device	: -
Suction strainer	: 316SS	Seal flush plan	: None
Column	: Steel A53 Type E GrB	Seal flush construction	: -
Lineshaft	: 416 stainless steel	Paint and Package	
Lineshaft bearing	: Bronze C84400	Pump paint	: -
Lineshaft sleeve		Support plate paint	: -
Discharge head	: Steel A53 Gr B/A36	Shipment type	: -
Support plate	: None supplied	Additional information	
Weights (Approx.)		Pit / sump depth	: 393.00 ft
Complete pump	: -	Pump length	: 393.92 ft
Mounting plate	: -	mounting surface to bell/strainer bottom	
Driver (net)	: -	Available well diameter	: 100.00 in
Testing		Max dia below mtg surface	: 16.00 in
Hydrostatic test	: None		
Performance test	: Witnessed		
NPSH test	: None		
Notes			
-			
-			
-			
-			

Customer	: AECOM	Pump / Stages	: 15EMM	/ 5
Customer reference	: AECOM	Based on curve no.	: EC-2377	
Item number	: IRWD PFAS OPA-1 Revision 4	Flowserve reference	: 3134504635	
Service	: Orange Park Acres	Date	: May 19, 2021	
Duty Conditions		Performance		
Quantity of pumps	: 2	Hydraulic power	: 245 hp	
Liquid description	: Potable Water	Pump overall efficiency	: 79.8 %	
Liquid type	: Other	NPSH3 @ Impeller eye	: 16.5 ft	
Frequency	: 60 Hz	Rated brake power	: 307 hp	
Flammable	: No	Maximum brake power	: 319 hp	
Toxic	: No	Motor rating	: 350 hp / 261 kW	
H2S	: No	Ns / Nss	: 1,519 / 9,100 (US units)	
Rated flow	: 2,000.0 USgpm	MCSF	: 748.0 USgpm	
Rated head	: 486.33 ft @ Low liquid level	Rated impeller diameter	: 11.44 in	
NPSHa	: 73.8 ft @ Low liquid level	Maximum impeller diameter	: 11.83 in	
Viscosity	: 1.00 cSt	Minimum impeller diameter	: 10.75 in	
Specific gravity	: 0.999	Maximum head	: 671.76 ft	
Maximum suction pressure	: 0.0 psig @ -	Flow at BEP	: 2,015.4 USgpm	
Rated suction pressure	: 0.0 psig	Flow as % of BEP	: 99.2 %	
Maximum liquid temperature	: 60 °F	Rated/max diameter	: 96.7 %	
Vapor pressure	: 0.26 psia	Head rise to shut off	: 36.6 %	
Altitude	: -	Rated/max head	: 88.5 %	
Static head	: -	Visc. capacity correction factor (CQ)	: 1.00	
Pump length strategy used	: As required for NPSH and submerg...	Visc. head correction factor (CH)	: 1.00	
		Visc. efficiency correction factor (CE)	: 1.00	
Selection status				
Product line	: VTP Wet Pit	Business unit	: Taneytown	
Pump speed	: 1,775 rpm	Selection status	: Near Miss	
Working Pressure Limits		Flow Velocities and Nozzle Sizing		
Bowl assembly MRWP	: 290.5 psig	Nozzle sizing strategy based on	: Flanged - Std Wall	
Column assembly MRWP	: 290.5 psig	Discharge nozzle design flow	: 2,000.0 USgpm	
Discharge region of discharge head MRWP	: 121.4 psig	Actual calculated discharge velocity	: 5.59 ft/s	
Bowl assembly MAWP	: 375.0 psig	Actual discharge inside diameter	: 12.09 in	
Column assembly MAWP	: 392.0 psig	Actual calculated column velocity	: 6.02 ft/s	
Discharge region of discharge head MAWP	: 285.0 psig			
Hydrostatic Test Pressures (when purchased)		Additional Performance		
Bowl / Column Assemblies HTP	: 363.2 psig / 363.2 psig	Torque rating (max power)	: 18.0 hp/100 rpm	
Discharge region of discharge head HTP	: 151.8 psig	Torque rating (rated power)	: 17.3 hp/100 rpm	
		Overall torque limit of pump shafts	: 20.2 hp/100 rpm	
		Pump WR ² at 1,775 rpm	: -	
Materials		Sump & Submergence		
Requested pump material	: B30	User defined well / sump opening	: 100.00 in	
Selected pump material	: B30	Required minimum well / sump opening	: 18.50 in	
Bowl material	: Cast Iron A48 CL30	User defined pit depth	: 393.00 ft	
First stage impeller material	: 316LSS A743 GR CF-3M	Min req. pit depth for pump length	: 394.08 ft	
Upper stage impeller material	: 316LSS A743 GR CF-3M	Combined bowl & column assembly length	: 393.92 ft	
Bowl wear ring material	: 410 Stainless Steel	Clearance from strainer/bearing hub to sump bottom	: 4.00 in	
Impeller wear ring material	: 12%Chrome A743-CA6NM	Available submergence above bell lip	: 32.00 in	
Bowl shaft material	: 17-4 Ph 900	Req. min. submergence above bell lip	: 32.00 in	
Bowl bearing material	: Rubber	User defined NPSHa	: 73.8 ft	
Column material	: Carbon steel	User defined mounting surf. to LLL	: 390.00 ft	
Lineshaft material	: 416 stainless steel	Max allowed LLL for pump length	: 390.00 ft	
Open lineshaft bearing material	: NONE	NPSHa at eye of impeller	: 75.4 ft	
Discharge head material	: Carbon Steel	NPSH3 @ Impeller eye	: 16.5 ft	

Customer	: AECOM	Pump / Stages	: 15EMM	/ 5
Customer reference	: AECOM	Based on curve no.	: EC-2377	
Item number	: IRWD PFAS OPA-1 Revision 4	Flowserve reference	: 3134504635	
Service	: Orange Park Acres	Date	: May 19, 2021	

Performance Corrections			
Head Corrections		Efficiency Corrections	
Pump rated head at discharge flange	: 95.33 ft	Bowl efficiency after correction	: 82.2 %
Discharge pressure at discharge flange	: 41.2 psig	Pump overall efficiency	: 79.8 %
C/L discharge flange to mounting surface	: 12.00 in		
Mounting surface to low liquid level	: 390.00 ft		
Pump rated head at low liquid level	: 486.33 ft		
Discharge head friction loss	: 0.60 ft		
Column friction loss	: 4.72 ft		
Bowl head	: 491.66 ft		

Construction and Dimensions			
Bowl Assembly Construction		Bowl Assembly Dimensions	
Bowl construction	: Flanged - Std Wall	Bowl shaft diameter	: 2.19 in
Bowl lining	: Lined bowls	Bowl O.D.	: 14.75 in
Impeller design	: Enclosed	Bell O.D.	: 14.75 in
Impeller fastening	: Colleted	Strainer O.D.	: 14.75 in
Strainer type	: Cone Strainer	Bowl assembly length to bell lip	: 87.00 in
Qty of unbalanced, std design impellers	: 5	Suction bearing hub length below bell lip	: 15.00 in
Qty of balanced, std design impellers	: -	Impeller eye to bell lip	: 12.75 in
Qty of unbalanced, alt first stage impellers	: -	Upper stages impeller rated diameter	: 11.44 in
Qty of balanced, alt first stage impellers	: -	First stage impeller rated diameter	: 11.44 in

Column Assembly Construction		Column Assembly Dimensions	
Column construction	: Flanged	Column nominal diameter	: 12.00 in
Column wall description	: Factory Default Wall Thickness	Column wall thickness	: 0.3750 in
Lineshaft lubrication	: Enclosed Lineshaft (Water Injection)	Column length	: 385.42 ft
Column flange rating	: FLS "Standard"	Max column segment length	: 120.00 in
Shaft split	: Separate bowl and lineshaft	Lineshaft diameter	: 1.69 in
Lineshaft coupling type	: Threaded coupling	Bearing span	: 60.00 in
Actual calculated column velocity	: 6.02 ft/s		

Discharge Head Assembly Construction		Discharge Head Assembly Dimensions	
Discharge head design	: "LF" - Fabricated / Above Grade Di...	Discharge position	: Above mounting surface
Discharge head size	: 12.00 in	C/L shaft to discharge flange face	: 19.00 in
Discharge head flange spec./rating	: 150 lb ANSI/ASME B16.5 or B16.4...	C/L head discharge to mounting surface	: 12.00 in
Discharge flange size	: 12 in	Shaft diameter through stuffing box	: 1.69 in
Head shaft sealing method	: Packing		
Driver shaft type	: Hollow shaft driver		
Solid shaft coupling type	: No rigid coupling required		
Solid shaft coupling size	: N/A		

Thrust Data			
Thrust bearing location	: -	Thrust with rated head/rated suction	: 7,694.8 lbf
Thrust stand selection method	: -	Thrust with shutoff head/rated suction	: 8,976.1 lbf
Thrust stand size	: -	Thrust with runout head/rated suction	: 6,129.5 lbf
Thrust used for stand sizing	: 7,694.8 lbf	Thrust with rated head/max suction	: 7,694.8 lbf
Max thrust limit for this design	: 12,000.0 lbf	Thrust with shutoff head/max suction	: 8,976.1 lbf
Min thrust limit for this design	: -	Thrust with runout head/max suction	: 6,129.5 lbf

Additional Notes	
Pump rejected because of:	
<ul style="list-style-type: none"> • BU review of pump length is required for technical and competitive pricing review • Specified sump depth 	

Appendix E: Bag Filter Cut Sheet

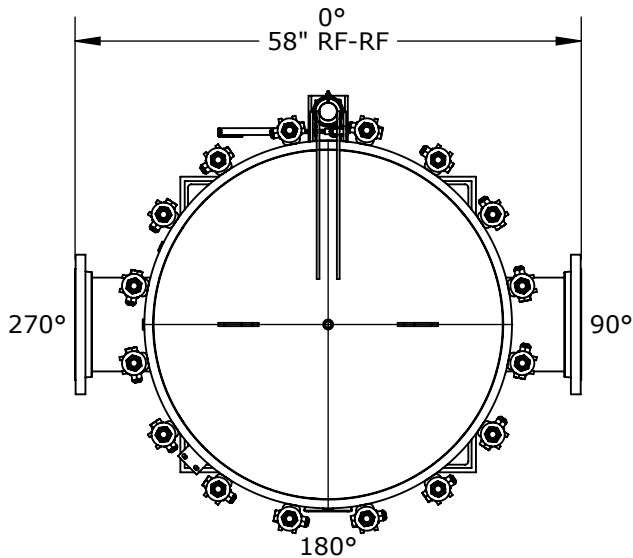

NOZZLE SCHEDULE			
MARK	QTY	SIZE / RATING	DESCRIPTION
N1	1	10" RFSO CL150	INLET
N2	1	10" RFSO CL150	OUTLET
N3	2	1/2" NPT CL3000	PRESSURE GAUGE
N4	1	1/2" NPT CL3000	VENT
N5	1	2" NPT CL3000	CLEAN DRAIN
N6	1	1/2" NPT CL3000	DIRTY DRAIN

VESSEL DESIGN CONDITIONS	
CODE: ASME SECTION VIII DIV. 1, 2019 EDITION	
M.A.W.P.: 150 PSI @ 250°F	M.D.M.T.: -20°F @ 150 PSI
M.A.W.P.: FV PSI @ 250°F	HYDROTEST PRESS: 195 PSI
CORROSION ALLOWANCE: N/A	SERVICE: UNK. LIQUID, NON-LETHAL
STAMP: U	RADIOGRAPHY: N/A
PWHT: N/A	GASKET: <input type="checkbox"/> BUNA <input type="checkbox"/> VITON <input type="checkbox"/> EPDM
MATERIAL: SS304	<input type="checkbox"/> OTHER:

NOTES:	FACTORY INSTALLED OPTIONS:
DRY WEIGHT: 1650 LBS	<input type="checkbox"/> STAINLESS STEEL BOLTING (SS316)
SHIPPING WEIGHT: 1900 LBS	<input type="checkbox"/> MESH LINED BASKETS: _____ MESH
VOLUME: 30.75 CU. FT.	<input type="checkbox"/> N3 DIFFERENTIAL PRESSURE GAUGE
INTERNALS: 18x SIZE 2 BASKETS	TYPE: _____
	<input type="checkbox"/> N4 PRESSURE RELIEF VALVE
	TYPE: _____
	<input type="checkbox"/> N4 AIR ELIMINATOR
	TYPE: _____
	<input type="checkbox"/> N4 VENT VALVE
	<input type="checkbox"/> N5/N6 DRAIN VALVES

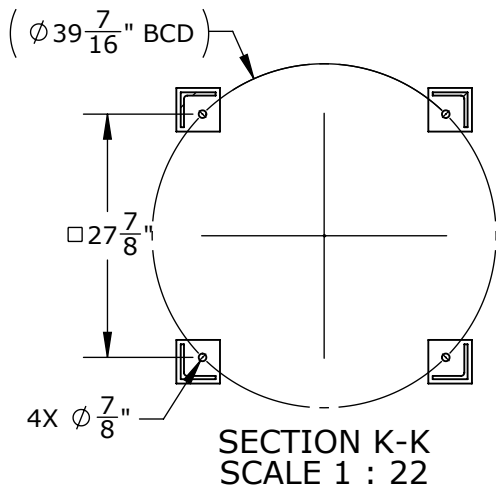
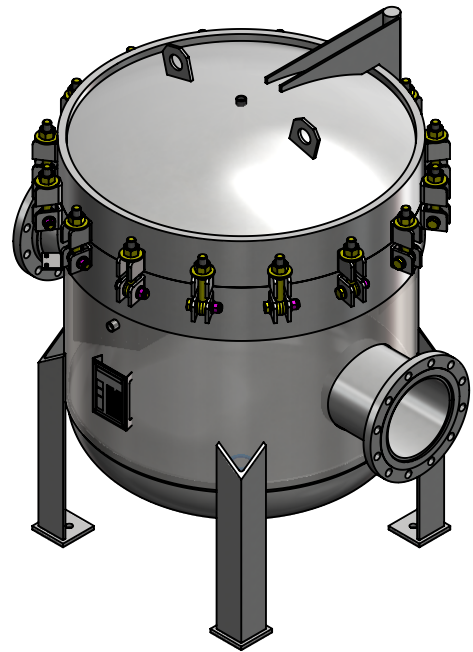
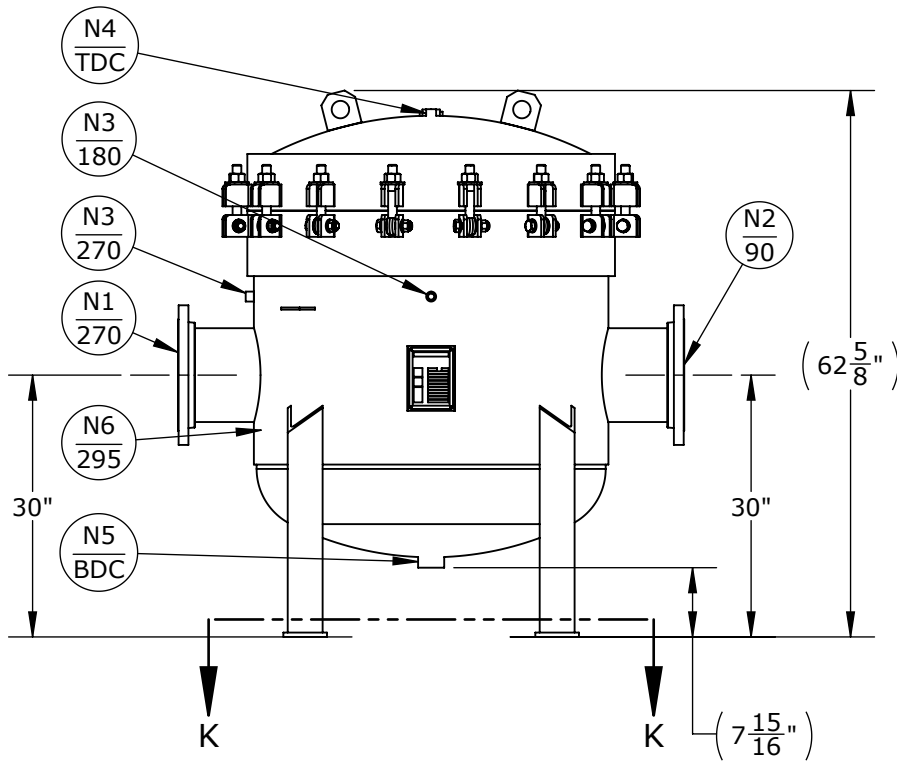

APPROVED WITH MARK-UPS APPROVED

 THIRD ANGLE PROJECTION	 55 Stafford Court Cambridge, Ontario N1T 1B3 Canada		FIL-TREK CORPORATION Phone: (519) 623-7448 Fax: (519) 623-8807 Email: info@fil-trek.com Website: www.fil-trek.com	
	THIS DRAWING IS THE PROPERTY OF 'FIL-TREK CORPORATION' AND MUST NOT BE COPIED OR USED IN ANY WAY DETRIMENTAL TO THE CORPORATION			
TOLERANCES-UNLESS OTHERWISE NOTED DECIMAL .X = ±.1" .XX = ±.02" .XXX = ±.005" FRACTIONAL = ±1/8" ANGULAR = ± 1° MAX. MACHINED SURFACE FINISH 125/√		EQUIPMENT: LP SERIES (BAG FILTER VESSEL) MODEL NO: S4LP40-1812-10F-B-150 CUSTOMER:		
VESSEL QUANTITY:		DRAWN: AJ DATE: 2020-03-05 CHK'D: TS	SERIAL No.	Part No. 002004-01652
		SCALE: NTS		REV. No. 0



LP SERIES

Bag Filter Housing
ASME Design
Universal

CONTENTS

- A. Shut Down and Cover Removal
- B. Media Replacement Components
- C. Cover Replacement and Start-Up
- D. Warranty
- E. Spare Parts List

LP SERIES

Installation and Operation Manual

WARNING:

Please read installation, operation manual, and media installation/replacement instructions prior to operating your LP Fil-Trek vessel.

Improper use of this model can result in personal injury and property damage.

FIL-TREK CORPORATION

ONTARIO	ALBERTA
70 Fleming Drive	7476 49 th Avenue
Cambridge, ON	Red Deer, AB
N1T 2B1	T4P 1M2
PH: (519) 623-7448	PH: (403) 346-6476
FX: (519) 623-8807	FX: (403) 346-5152

EMAIL: info@fil-trek.com
WEBSITE: www.fil-trek.com

LP SERIES

Bag Filter Housing
ASME Design
Universal

A) SHUT DOWN AND COVER REMOVAL

SWING BOLT CLOSURE

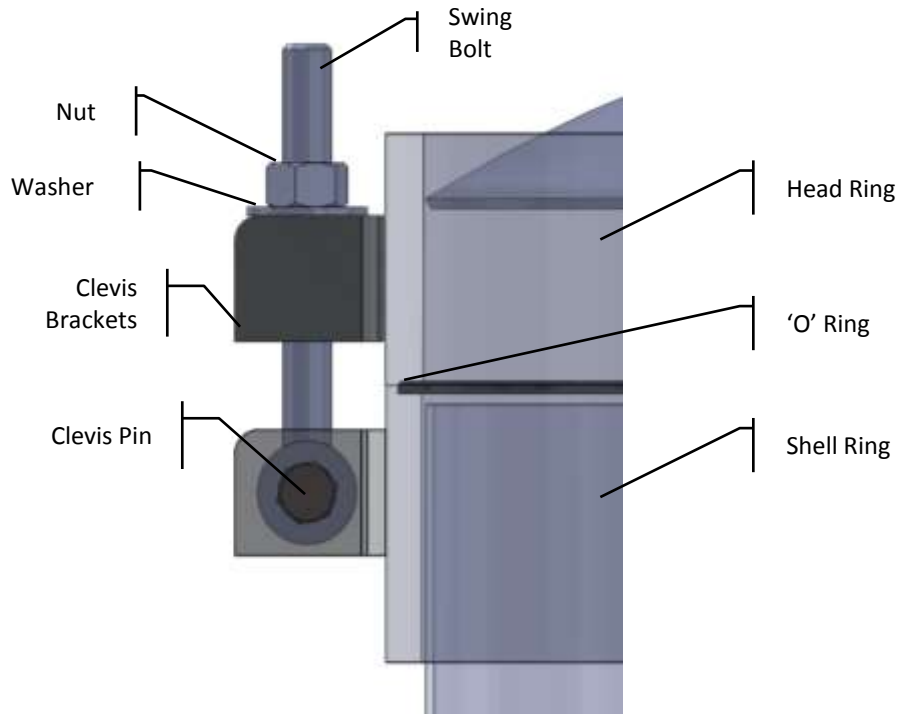

Operator Warning: Do not attempt to open the filter housing while the inlet/outlet valves are open, or while the filter housing contains pressure.

1. Inlet and/or pressure inlet valve must always be closed first.
2. Shut off outlet and/or discharge side valve(s).
3. Any pressure, which may be in the filter housing after the inlet and outlet valves have been closed, should be vented before attempting to open the filter housing. Care should be taken to keep face and hands protected and clear of filter vessel while venting the filter housing.
4. Drain the filter housing by opening the side and bottom drain valves. The dirty drain is located on the side of the LP Series filter housing and the clean drain is located on the bottom of the vessel.

CAUTION: Do not, at any time remove or loosen the swing bolts before draining. Failure to drain the vessel can result in pressurized fluid being trapped in the vessel. Fluid may spray out when the swing bolts are loosened causing personal injury or damage to equipment.

FIL-TREK CORPORATION

ONTARIO

70 Fleming Drive
Cambridge, ON
N1T 2B1

PH: (519) 623-7448
FX: (519) 623-8807

ALBERTA

7476 49th Avenue
Red Deer, AB
T4P 1M2

PH: (403) 346-6476
FX: (403) 346-5152

5. Open the air vent to relieve the housing pressure.
6. Loosen the cover nuts (eye or hex) in an alternate diagonal pattern.
7. A head lift with a hand wheel is standard on all vessels that are greater than 12" diameter or have a cover weighing more than 30lbs. Make sure to raise the cover high enough to clear the cartridge compression springs and guide pin.

EMAIL: info@fil-trek.com
WEBSITE: www.fil-trek.com

B) MEDIA REPLACEMENT COMPONENTS

LP SERIES

Bag Filter Housing
ASME Design
Universal

Fil-Trek LP model housings will accept most size two and size one filter bags. These filter bags are supported by perforated filter baskets. For maximum filtration efficiency, Fil-Trek recommends that bags should be replaced @ 15-20 PSI D dirty unless otherwise specified

1. After the cover is removed, lift the used filter bag by grasping the loop on the bag and lifting the bag upwards.
2. Once the filter bag is removed it is then discarded.
3. Then remove the support basket out of the vessel to clean and inspect the basket for any damage.
4. Clean and inspect the filter housing interior and all components. The o-ring groove and o-ring must be inspected for damage.
5. Install the support basket into the LP housing.
6. Install the new Fil-Trek filter bag.
7. Make sure to spread out the filter bag inside the support basket.

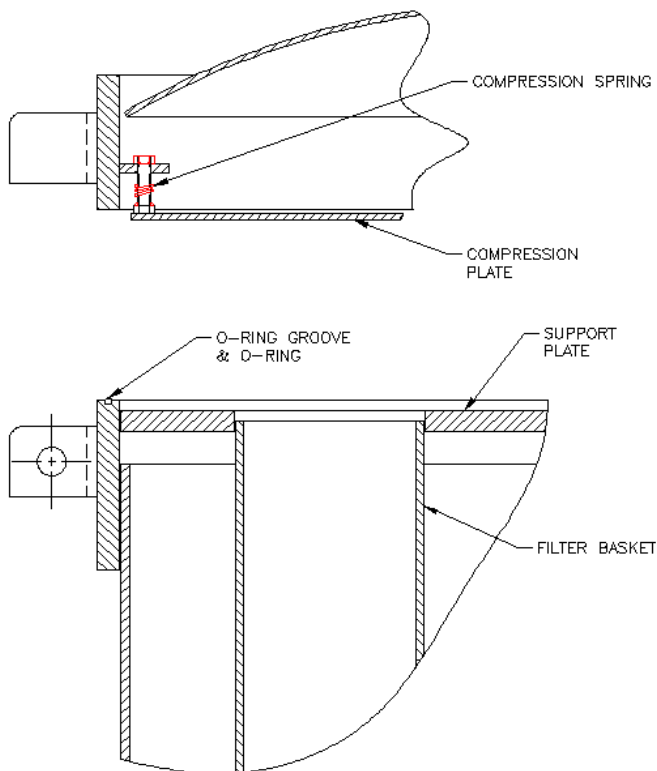

THE WARRANTY IS VOID IF ANY OF THE SPARE PARTS ARE NOT SUPPLIED BY FIL-TREK CORPORATION OR ONE OF ITS DIVISIONS.

FIL-TREK CORPORATION

ONTARIO	ALBERTA
70 Fleming Drive	7476 49 th Avenue
Cambridge, ON	Red Deer, AB
N1T 2B1	T4P 1M2
PH: (519) 623-7448	PH: (403) 346-6476
FX: (519) 623-8807	FX: (403) 346-5152

EMAIL: info@fil-trek.com
WEBSITE: www.fil-trek.com

LP SERIES

Bag Filter Housing
ASME Design
Universal

C) COVER REPLACEMENT AND START-UP

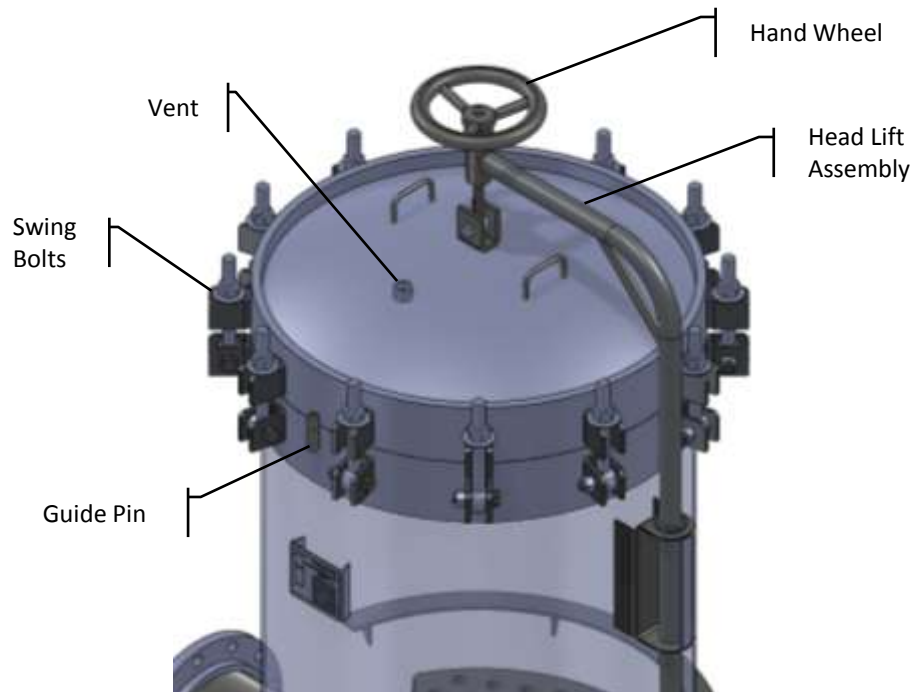

1. Clean and inspect the gasket seating surface. Re-lubricate the gasket heavily with petroleum jelly.
2. Swing bolts and nuts should be cleaned, inspected and lubricated.
3. Position the cover over the filter body and align the clevis bracket notches with the swing bolts. If your LP Series vessel has a domed top head there will be a guide pin, which will assist with aligning the cover into place. After the cover is properly aligned, turning the hand wheel, in a counterclockwise motion, will lower the cover.
4. After the cover is lowered into place, position the swing bolts to the cover and install the nuts (hex or eye).
5. Tighten the nuts by following the torque procedure.
6. Close the drain valve and open the vent valve or plug.
7. Open the inlet valve and allow the vessel to fill slowly.
8. When air is expelled from the vessel and liquid begins to bleed from the vent, close the vent valve.
9. Open the outlet valve(s).

FIL-TREK CORPORATION

ONTARIO

70 Fleming Drive
Cambridge, ON
N1T 2B1

PH: (519) 623-7448
FX: (519) 623-8807

ALBERTA

7476 49th Avenue
Red Deer, AB
T4P 1M2

PH: (403) 346-6476
FX: (403) 346-5152

EMAIL: info@fil-trek.com

WEBSITE: www.fil-trek.com

TORQUE PROCEDURE

The torque procedure is as follows:

1. Bolts must be all be snug tight before starting.
2. Apply the starting torque, shown below working in a star pattern.

BOLT SIZE	STARTING TORQUE
1/2"	20 ft-lbs.
5/8"	30 ft-lbs.
3/4"	40 ft-lbs.
1"	50 ft-lbs.
1 1/8"	75 ft-lbs.

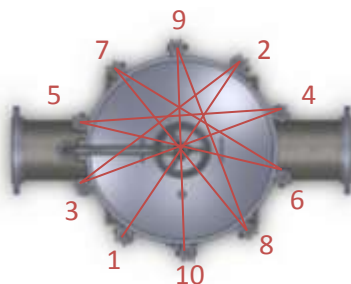

3. Apply an additional 20ft-lbs of torque working in the same star pattern
4. Bring the vessel up to working pressure.
5. If the vessel begins to leak from the seal, relieve the pressure by 25% from where the pressure vessel began to leak. After the pressure has been dropped add additional 15ft-lb increments in the same star pattern until the unit is sealed. Do not exceed the specified maximum value of torque shown below and do not over torque the vessel to the point of bending the vessel's washers.

BOLT SIZE	MAXIMUM TORQUE
1/2"	100 ft-lbs.
5/8"	150 ft-lbs.
3/4"	200 ft-lbs.
1"	250 ft-lbs.
1 1/8"	300 ft-lbs.

TROUBLESHOOTING

If cover is still leaking after following the above torque procedure:

1. Remove the cover and inspect the O-Ring.
2. Make sure O-Ring is clean, not twisted, pinched or damaged and well lubricated.
3. Make sure mating faces are clean and undamaged.
4. If problem persists, contact Fil-Trek.

FIL-TREK CORPORATION

ONTARIO	ALBERTA
70 Fleming Drive	7476 49 th Avenue
Cambridge, ON	Red Deer, AB
N1T 2B1	T4P 1M2
PH: (519) 623-7448	PH: (403) 346-6476
FX: (519) 623-8807	FX: (403) 346-5152

EMAIL: info@fil-trek.com
WEBSITE: www.fil-trek.com

D) WARRANTY

Seller warrants that the items sold hereunder shall be free from defects in material or workmanship for a period of *12 MONTHS AFTER STARTUP* or *18 MONTHS AFTER THE DATE OF SHIPMENT* from Fil-trek Corporation or one of its divisions, whichever comes first. This warranty comprises the sole and entire warranty pertaining to items provided hereunder. Seller makes no other warranty, guarantee, or representation of any kind whatsoever. All other warranties, including but not limited to, merchantability and fitness for purpose, whether express, implied, or arising by operation of law, trade usage, or course of dealing, are hereby disclaimed.

Notwithstanding the foregoing, there are no warranties whatsoever on items built or acquired wholly or partially, to buyer's designs or specifications.

Limitation of Remedy: Seller's liability arising from or in any way connected with the items sold or this contract shall be limited exclusively to repair or replacement of the items sole or refund of the purchase price by buyer, at seller's sole option. In no event shall seller be liable for any incidental, consequential, or special damages of any kind or nature whatsoever, including but not limited to lost profits arising from or in any way connected with this agreement or items sold hereunder, whether alleged to arise from breach of contract, express or implied warranty, or in tort, including without limitation, negligence, failure to warn or strict liability.

**THE WARRANTY IS VOID IF ANY OF THE SPARE PARTS ARE NOT SUPPLIED
BY FIL-TREK CORPORATION OR ONE OF ITS DIVISIONS.**

FIL-TREK CORPORATION

ONTARIO

70 Fleming Drive
Cambridge, ON
N1T 2B1

PH: (519) 623-7448

FX: (519) 623-8807

ALBERTA

7476 49th Avenue
Red Deer. AB
T4P 1M2

PH: (403) 346-6476

FX: (403) 346-5152

EMAIL: info@fil-trek.com

WEBSITE: www.fil-trek.com

E) SPARE PARTS LIST

SERIAL NUMBER _____

MODEL NUMBER _____

QTY _____

CUSTOMER _____

YEAR BUILT _____

PART NUMBER	DESCRIPTION	QTY REQUIRED PER UNIT	QTY TO ORDER

LP SERIES

Bag Filter Housing
ASME Design
Universal



Note: LP Series housings accept universal size 1 and 2 bag filters.
Please visit our website for more information.

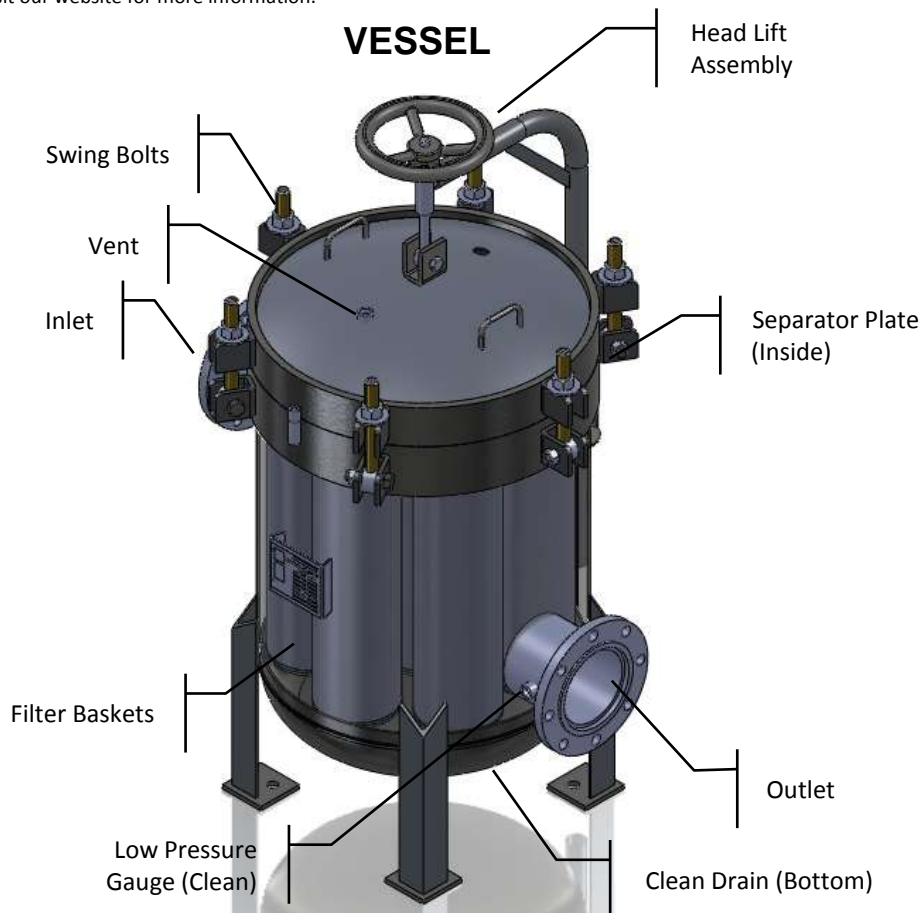

FIL-TREK CORPORATION

ONTARIO	ALBERTA
70 Fleming Drive	7476 49 th Avenue
Cambridge, ON	Red Deer, AB
N1T 2B1	T4P 1M2
PH: (519) 623-7448	PH: (403) 346-6476
FX: (519) 623-8807	FX: (403) 346-5152

EMAIL: info@fil-trek.com
WEBSITE: www.fil-trek.com

FOR SPARE PARTS INQUIRIES OR FOR A DETAILED DRAWING OF YOUR HOUSING, PLEASE CONTACT FIL-TREK DIRECTLY.

Appendix F: IX Vessels Cut Sheet

TABLE ONE: SCOPE OF SUPPLY CHECK

No	Work Scope Item	Others	Evoqua
1	Equipment system(s) as proposed herein		X
2	Equipment quality assurance check on site		X
3	Site(s) for the Evoqua equipment/facility that comply with the requirements of the hydraulic profile, process flow, or special design requirements	X	
4	Permanent electrical services, terminated at the control panels or instruments within the Evoqua Water Technologies, LLC. equipment/facility battery limit(s). Voltage & amperage TBD as specified by Evoqua.	X	
5	Valved supply of temporary pump test water to the Evoqua equipment/facility battery limit(s)	X	
6	Discharge of effluent water(s) such as process return, outfall, wastewater, or sewer tie-in within the Evoqua equipment/facility battery limit(s).	X	
7	Valved supply of permanent compressed and/or instrument quality air and/or potable water to the Evoqua equipment/facility battery limit(s). Volume & pressure TBD.	N/A	
8	Instrumentation field calibration	X	
9	Supply and installation of piping to Evoqua provided equipment boundary	X	
10	Supply of Interconnecting isolation valves, check valves, control valves, etc. between systems	X	
11	Offloading of vessels and piping, installation of vessels and Evoqua supplied piping	X	
12	Supply of loose instrumentation in between equipment components (differential pressure transmitters)		X
13	Wiring of loose instruments to junction boxes and/or control panels	X	
14	Interconnecting conduit and wiring between unit components and existing power and control distribution	X	
15	Field testing of unit assemblies	X	
16	Installation and Startup Supervision	X	
17	Manuals or Operating Instructions (2)		X
18	Chemical sanitization, qualification	X	
19	Initial load of Media	N/A	
21	Anti-Siphon Loop	X	
22	Grounding of Evoqua provided equipment	X	

HP®1220CIX SYS

DUAL MEDIA GAC/RESIN ADSORPTION SYSTEM SPECIFICATION SUMMARY

HP®1220CIX SYS Liquid Phase Adsorption Systems are designed to treat a wide range of contaminated process streams. Piping and valves are configured for series, parallel, or vessel isolation flows. System includes GAC/RESIN inlet and outlet piping, and backwash capabilities (for GAC Only). The system consists of two adsorbers, with all piping, valves, and gauges assembled for ease of operation. The adsorbers are equipped with underdrains for maximum series flow rate of 525 GPM for GAC and 1600 GPM for Resin.

EACH VESSEL:

Vessel Diameter	144"
Side Shell Height	60"
Overall Height (Approx.).....	16'-4"
Maximum Working Pressure	125 psi @ 140 °F
Manway:	
Flanged at side shell	24"
Elliptical type at head	14" x 18"
Vessel Volume	7,520 gal.
Carbon Volume	700 Ft ³
Resin Volume	424 Ft ³ .
Maximum Flow Rate (GAC)	525 GPM
Empty Bed Contact Time (GAC)	10 min/vessel @ 525 GPM
Maximum Flow Rate (Resin)	1600 GPM
Empty Bed Contact Time (GAC)	2 min/vessel @ 1600 GPM
ASME Code Stamping	YES
Material	Carbon Steel
Supports	Wide Flange Legs
Lifting	Lifting Lugs
Seismic	Current IBC
Interior Surface Prep	SSPC-SP5
Interior Surface Coating	Plasite 4110 35 mil dft min
Exterior Surface Primer	Carboguard 890 Epoxy 4-6 mil dft
Exterior Surface Coating	Carbothane 133VOC Urethane 3-4 mil dft
Standard Color.....	Cashew #9225

CONNECTIONS:

Inlet / Outlet	10" 150# ANSI Flanged
Media Fill / Media Discharge	4" Kamlock
Backwash (GAC Only)	8" Flanged
Utility Water	2" Kamlock

All information presented herein is believed reliable and in accordance with accepted engineering practices. Evoqua makes no warranties as to completeness of information. Users are responsible for evaluating individual product suitability for specific applications. Evoqua assumes no liability whatsoever for any special, indirect or consequential damages arising from the sale, resale or misuse of its products.

Evoqua reserves the right to change the specifications referred to in this literature at any time, without prior notice.

UNDERDRAINS:

External Ring Header 10" Sch. 40 Epoxy Lined Carbon Steel
Screens 8 ea 316L Stainless Steel V-Wire X-Box Screens 4 ½" dia. x 10"

VALVE ASSEMBLY AND PIPING:

Piping:

Process Piping 10" Schedule 40 Carbon Steel, Epoxy Lined
GAC Transfer Piping 4" Sch 40 Carbon Steel, Epoxy Lined

Valves:

Process 10" Butterfly, Cast Iron Body w/SS Disk, Gear Operator
GAC Transfer 4" Flanged 316 Stainless Steel Ball Valve
Drain/Wash 2" Bronze Ball Valve
Sample Ports (3) 1/2" Bronze Ball Valve

SYSTEM WEIGHT:

System Shipping weight (Two Vessels Piping & Manifold) 43,000 lbs.
Operating Weight (with UC1240LD GAC) 180,000 lbs.
Operating Weight (with PSR2+ Resin) 192,000 lbs.

FOR ADDITIONAL INFORMATION, PLEASE CONTACT YOUR NEAREST
CARBON SERVICE BRANCH AT:

866-613-5620

All information presented herein is believed reliable and in accordance with accepted engineering practices. Evoqua makes no warranties as to completeness of information. Users are responsible for evaluating individual product suitability for specific applications. Evoqua assumes no liability whatsoever for any special, indirect or consequential damages arising from the sale, resale or misuse of its products.

Evoqua reserves the right to change the specifications referred to in this literature at any time, without prior notice.

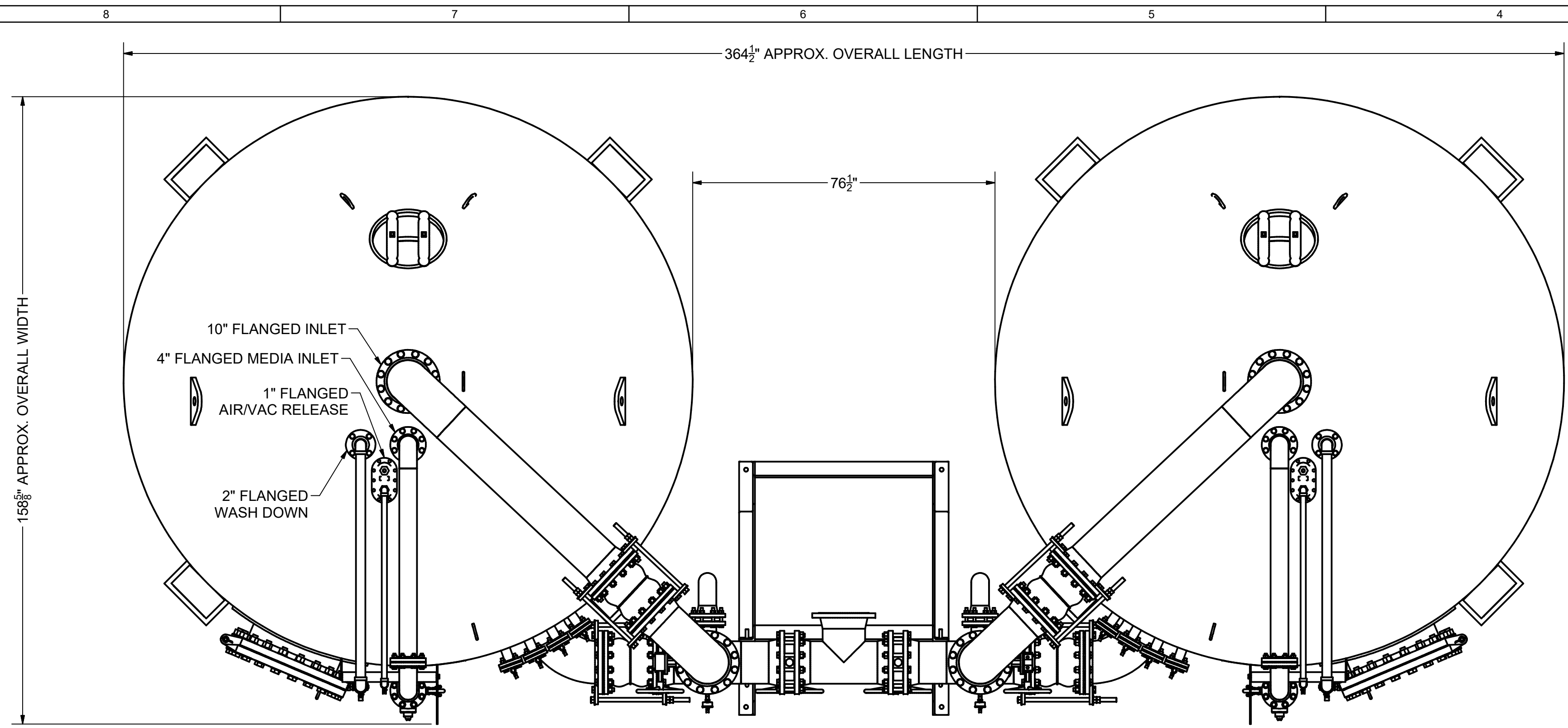

PLAN VIEW

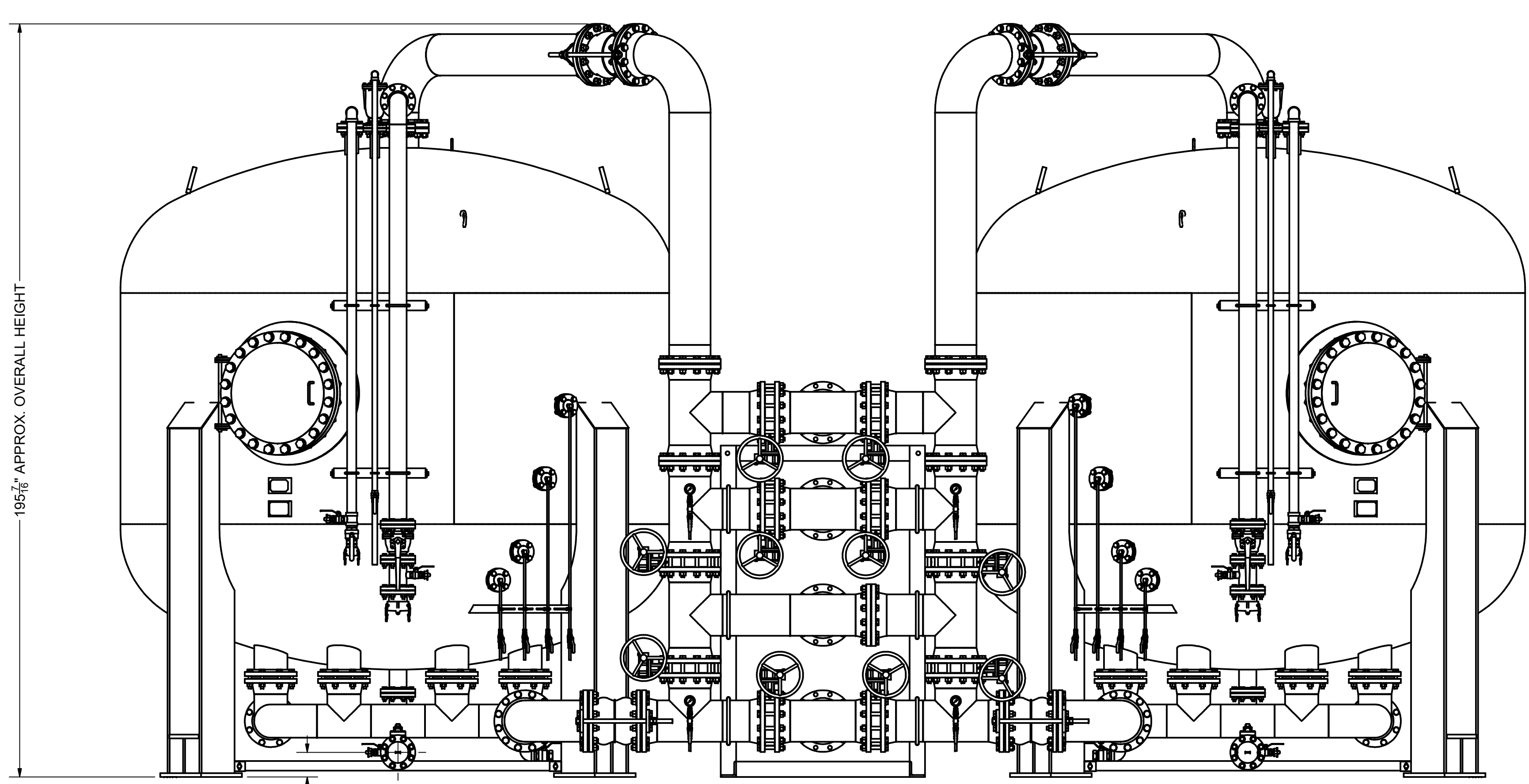

FRONT VIEW

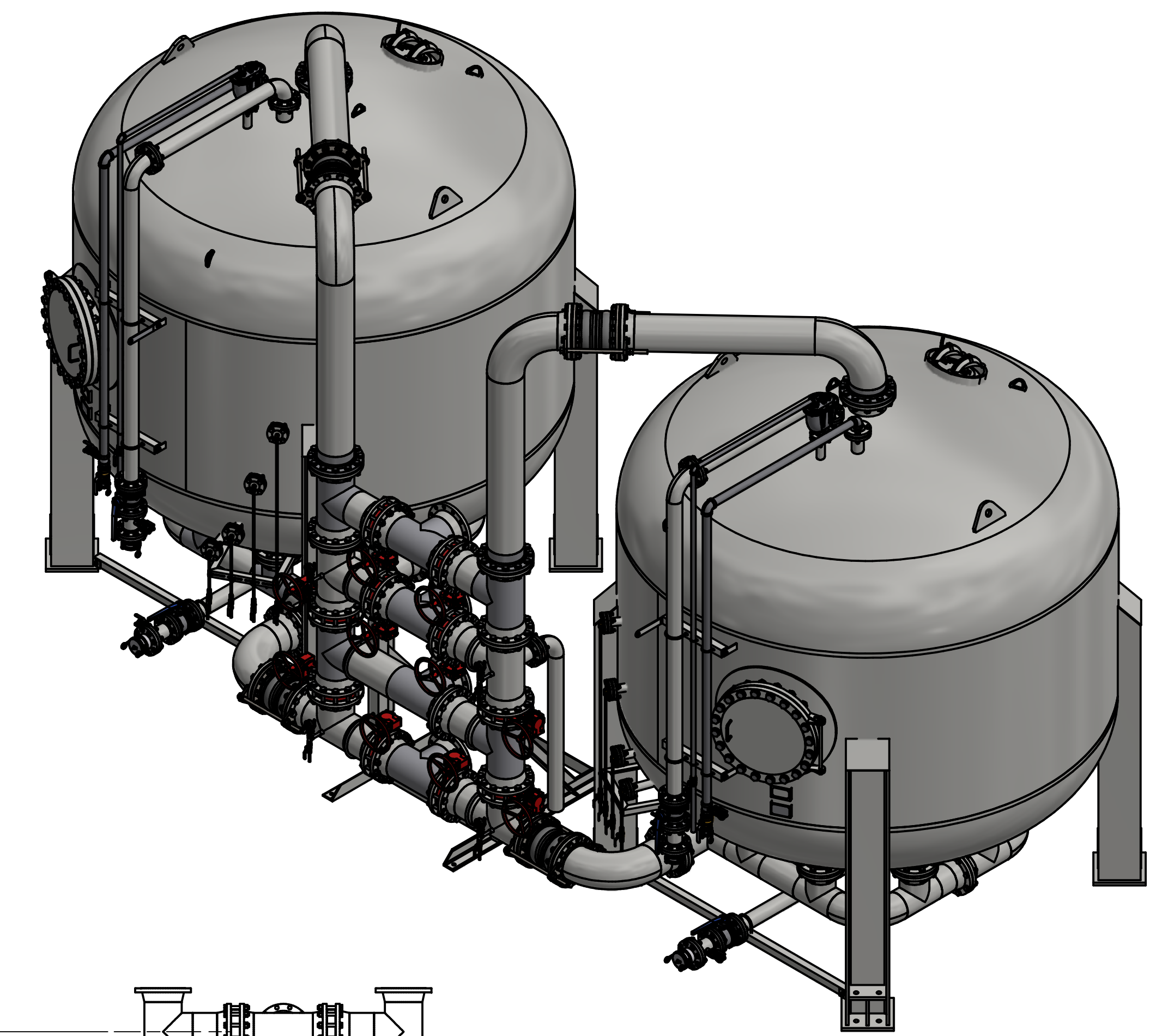

APPROX. WEIGHT: 43,000 LB

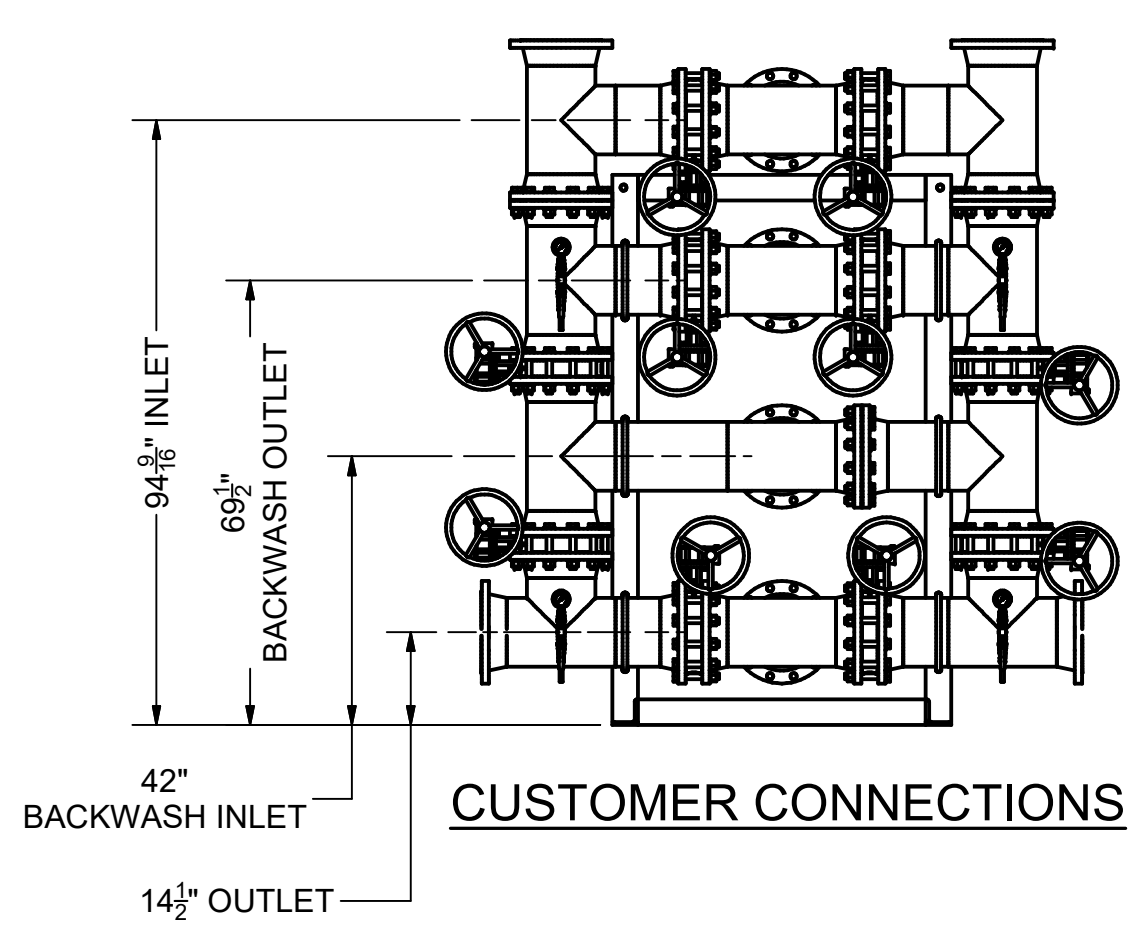

CUSTOMER CONNECTIONS

- NOTES:**
- 1.) THIS DRAWING IS TO SHOW PIPING AND EQUIPMENT FOR GENERAL INFORMATION.
 - 2.) ALL BUTTERFLY VALVES ARE DUCTILE IRON WITH STAINLESS TRIM, STAINLESS STEEL DISK.
 - 3.) PROVIDE 316 STAINLESS STEEL SEPTA UNDER DRAIN SCREENS.
 - 4.) VESSELS SHALL BE 125 PSI, ASME CODE.
 - 5.) FINISH INTERIOR WITH PLASITE 4110, PREPARE AND APPLY STRICTLY IN ACCORDANCE WITH MANUFACTURERS RECOMMENDATIONS TO MEET NSF STD 61 REQUIREMENTS.
 - 6.) PIPING MATERIALS SHALL MEET: CS PIPE ASTM A-53 GRADE B (ERW); CS FITTINGS SA-234, ASME B16.9; SS THREADED FITTINGS ASTM A-351; SS PIPE ASTM A-312; SS BW FITTINGS ASTM A-403; MI THREADED FITTINGS ASME B-16.3.
 - 7.) FINISH EXTERIOR WITH CARBOGAURD 133 URETHANE COLOR TO BE 9225 CASHEW OVER CARBOLINE 890 RUST PREVENTATIVE EPOXY PRIMER APPLIED PER MFG. RECOMMENDATIONS.
 - 8.) MEDIA SLURRY LINES TO BE INTERNALLY COATED WITH SCOTCHKOTE 206N.
 - 9.) PROCESS PIPING TO BE NSF LINED.
 - 10.) SYSTEM ESTIMATED SHIPPING WEIGHT: 43,000 LBS.
 - 11.) GROUTING BY OTHERS IF REQUIRED.
 - 12.) ± 1" TOLERANCE ON CONNECTION DIMENSIONS.

<small>COMPANY CONFIDENTIAL INFORMATION</small> <small>THIS DOCUMENT AND ALL INFORMATION CONTAINED HEREIN, INCLUDING THE DESIGN CONCEPTS AND THOSE ARISING THEREFROM ARE THE PROPERTY OF EVOQUA AND/OR ITS AFFILIATES AND ARE SUBMITTED IN CONFIDENCE. THEY MAY BE USED ONLY FOR THE EXPRESS PURPOSE FOR WHICH THEY ARE PROVIDED AND MUST NOT BE DISCLOSED, REPRODUCED OR COPIED IN ANY FORM, INCLUDING IN ELECTRONIC FORMAT, LOANED OR USED IN ANY OTHER MANNER WITHOUT THE EXPRESS WRITTEN CONSENT OF EVOQUA. ALL PATENT RIGHTS ARE RESERVED. THIS DOCUMENT AND DERIVATIVE WORKS THEREOF ARE PROTECTED UNDER APPLICABLE COPYRIGHT LAWS. UPON DEMAND OF EVOQUA, THIS DOCUMENT, ALONG WITH ALL COPIES AND EXTRACTS, AND ALL RELATED NOTES AND ANALYSES MUST BE RETURNED TO EVOQUA OR DESTROYED, AS INSTRUCTED BY EVOQUA. ACCEPTANCE OF THE DELIVERY OF THIS DOCUMENT CONSTITUTES AGREEMENT TO THESE TERMS.</small>	DWN BY: RKC	DATE: 3/5/2020	TITLE: HP1220CIX SYS, 125 PSI ASME
	CKD BY:	DATE:	CLIENT:
	APPD BY:	DATE:	
	MGD BY:		
	REF:		
	SCALE: NOT TO SCALE		
		PROJECT: SALES	DMS REFERENCE:
		SHEET: 1 OF 1	REV: 0

STD:22x34_D_v1.6
 BAR = 1" AT PLOT SCALE
 Doc Group: Doc Type:

**Predicted System Pressure Loss
HP1220CIX Single Tank - No Media**

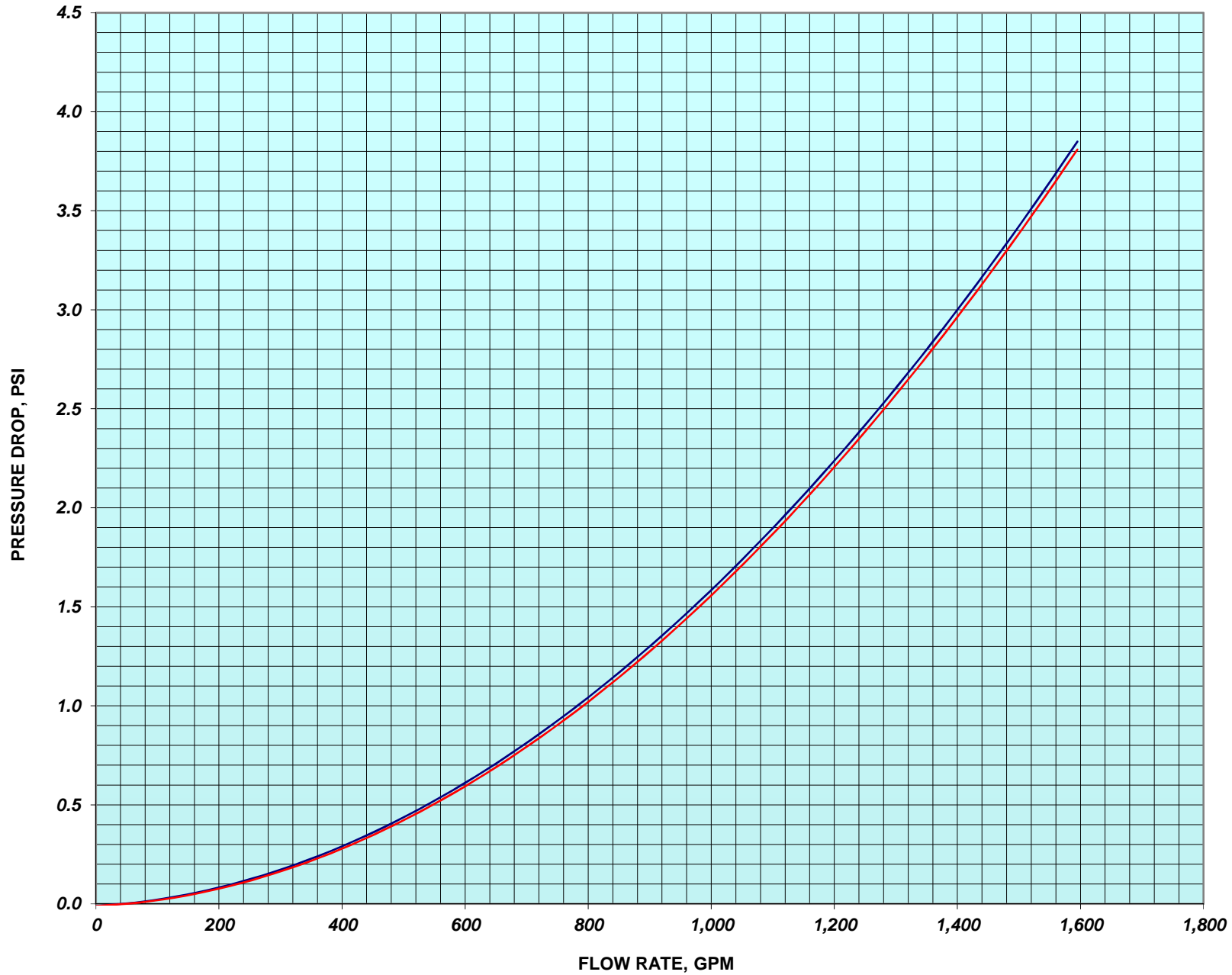

**0.01 inch screen
4 Way Diffuser with
Cans**

No Underbed

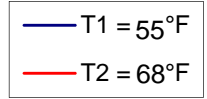

Predicted System Pressure Loss
HP1220CIX Series 2 Vessels - Media 424 ft³ of DOWEX PSR2+ - 10in CS Manifold

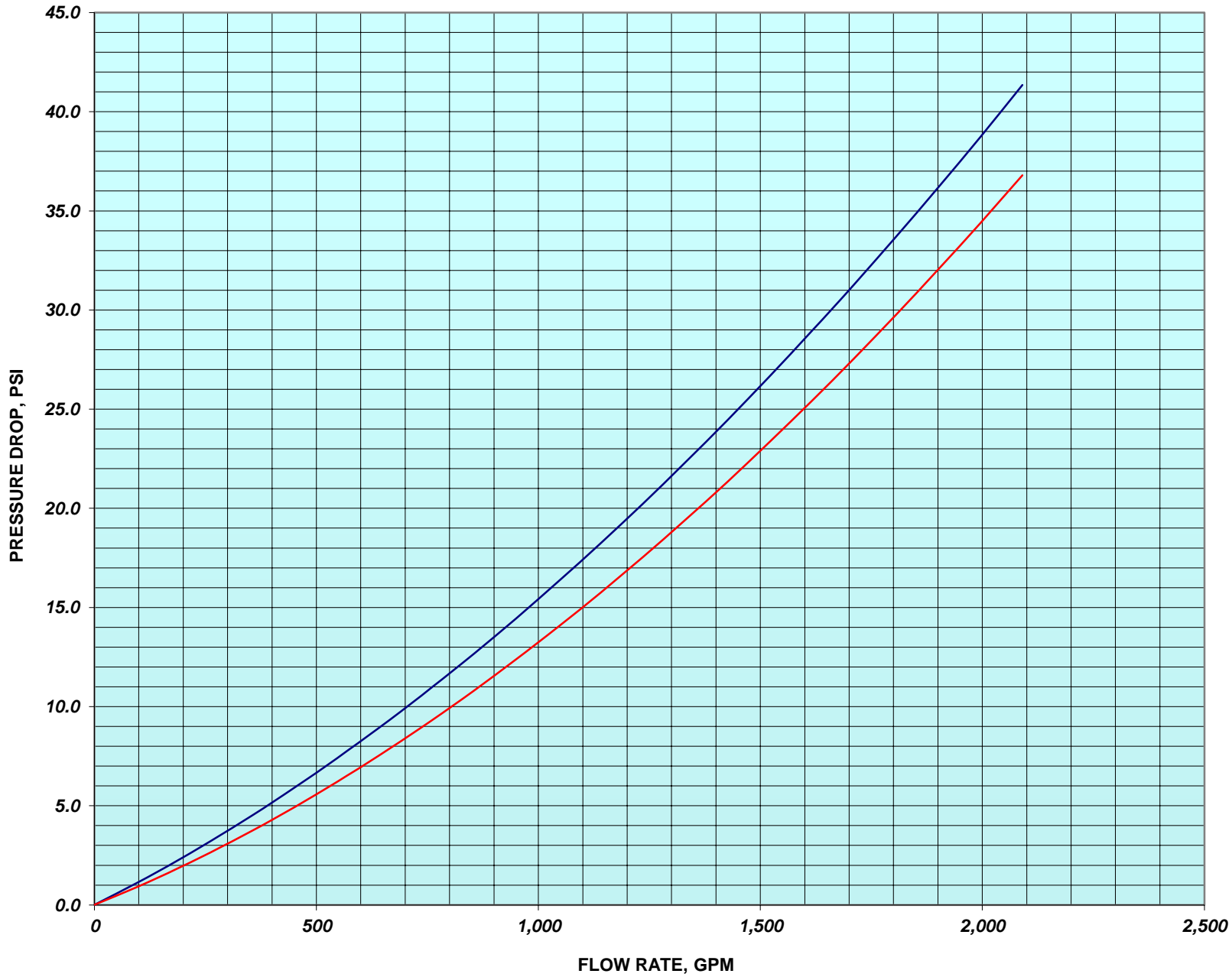

0.01 inch screen
4 Way Diffuser with
Cans

No Underbed

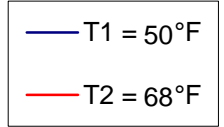

Appendix G: Sump Pump Cut Sheet



Model 98

Sump Pump

Professional Series Sump Pump Model 98 Features:

- 3-year warranty
- 2-pole mechanical switch
- 1/2 HP 115 V sump pump
- Performance up to 23' (7 m) TDH
- Flows up to 72 GPM (273 LPM)
- Cast iron switch case, motor and pump housing
- Corrosion-resistant, powder coated epoxy paint

100% factory tested



Trusted. Tested. Tough.®

zoellerpumps.com 800-928-7867
3649 Cane Run Road, Louisville, KY 40211 USA

FM3012
0520
Supersedes
0117

PRODUCT SPECIFICATIONS

MOTOR	Horse Power	1/2
	Voltage	115 or 230
	Phase	1 Ph
	Hertz	60 Hz
	RPM	1725
	Type	Permanent split capacitor
	Insulation	Class B
	Amps	4.7 - 9.4
	PUMP	Operation
Auto On/Off Points		9-1/2" (24 cm) / 3" (7.6 cm)
Discharge Size		1-1/2" NPT
Solids Handling		1/2" (13 mm) spherical solids
Cord Length		15' (5 m) standard
Cord Type		UL listed
Max. Head		23' (7 m)
Max. Flow Rate		72 GPM (273 LPM)
Max. Operating Temp.		130° F (54° C)
Cooling		Oil filled
Motor Protection		Auto reset thermal overload
MATERIALS	Cap	Cast iron
	Motor Housing	Cast iron
	Pump Housing	Cast iron
	Base	Engineered thermoplastic
	Upper Bearing	Oil-fed cast iron
	Lower Bearing	Oil-fed cast iron
	Mechanical Seals	Carbon and ceramic
	Impeller Type	Non-clogging vortex
	Impeller	Engineered plastic
	Hardware	Stainless steel
	Motor Shaft	AISI 1215 cold rolled steel
	Gasket	Neoprene

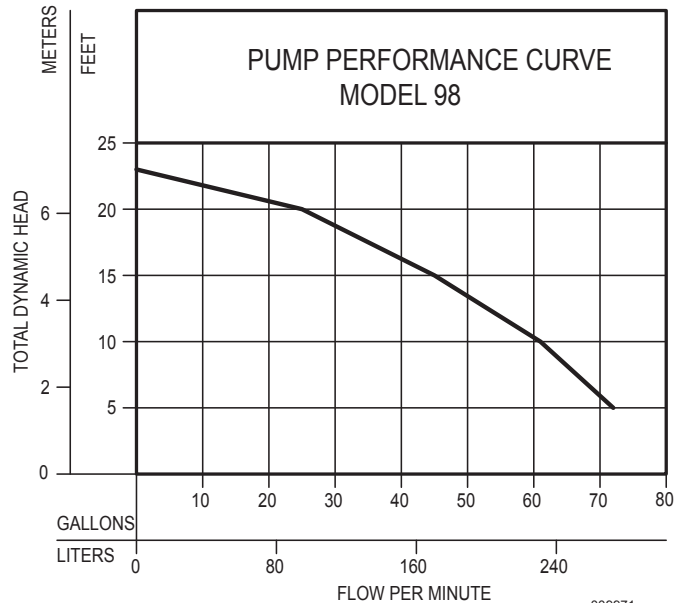
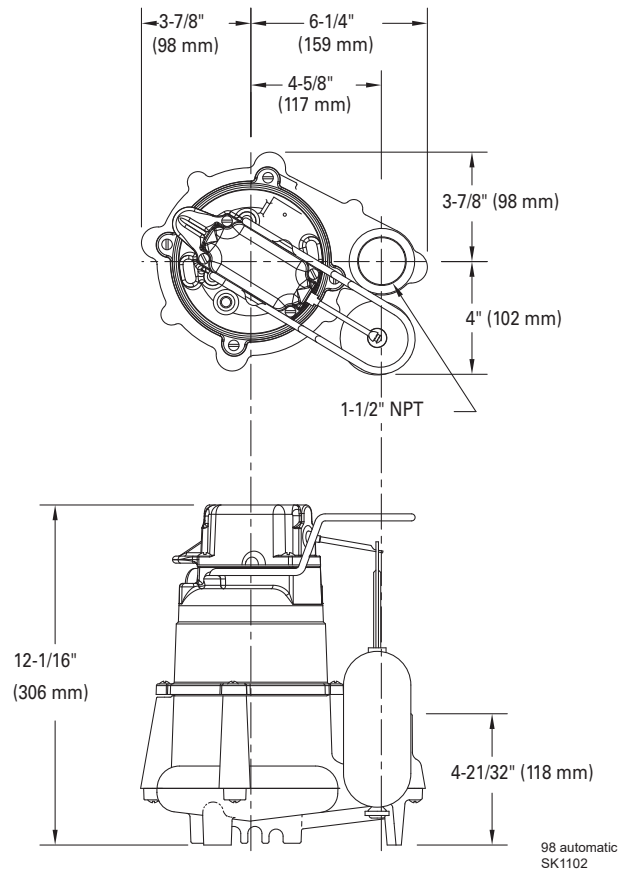



 Tested to Standard UL778 and
 Certified to CSA
 Standard C22.2 No. 108







Appendix H: Calculations Binder

Well Pump Hydraulic Calculations

Hydraulic Spreadsheet for Pumping Station Design

Version 1.0

PURPOSE:

The purpose of this spreadsheet is to aid in the design of pumping systems.

CONTENTS:

- | | |
|------------------------------|--|
| 1. Introduction: | Description of the capabilities of the hydraulic spreadsheet. |
| 2. Info Sheet | Sheet for input of descriptive information on the pumping system. |
| 3. TH Worksheet: | Calculates total head (station losses and system losses) for design condition. |
| 4. K values: | Reference for input of minor loss coefficients into hydraulic worksheet. |
| 5. System Curve Data: | Calculates data for plotting of representative system curve. |
| 6. Pump Curve Data: | Generates data for pump curve plot based on user defined pump curve. Capable of generating variable speed curves and curves for up to seven pumps in parallel or series. |
| 7. System Curves: | Graphical representation of system curves and station losses curve. |
| 8. Pump Curves: | Graphical Representation of Pump and System Curves. |
| 9. NPSH: | Calculates Net Positive Suction Head Available in pumping system |
| 10. Conversions: | Calculates unit conversions. |
| 11. Velocities: | Informational sheet on pipe velocities in the pumping system. |
| 12. Pump Data Sheet: | Compilation of data required to properly specify the pump |
| 13. Motors: | Motor data for informational purposes. |
| 14. Controls: | Information sheet on wetwell control elevations for a constant speed pumping operation. |
| 15. Seals: | Informational sheet on pump shaft seals. |
| 16. Bearings: | Informational sheet on pump shaft bearings. |
| 17. Materials: | Informational sheet on pump materials of construction. |

DIRECTIONS:

1. Input data into the TH Worksheet where prompted by the shaded cells
2. Be sure that units are correct. (Use "10. Conversions" if necessary.)
3. System Curves are automatically generated given the results from the Hydraulic Worksheet.
4. Select a pump given the results from the Hydraulic Worksheet.
5. Input points from the manufacturer's curve and other data into "6. Pump Curve Data":

Pumping System Descriptive Information

CLIENT: Orange County Water District & Irvine Ranch Water District

PROJECT: Orange Park Acres

JOB NO.: 60648259

COMPUTED BY: Benjamin T. Shanthikumar DATE: 3/5/2021

CHECKED BY: _____ DATE: _____

hyjn23 OPA-1 Well Pump (Alternative 2a)

PUMP FROM: OPA-1 well

PUMP TO: Wet Well

DESCRIPTION: Vertical turbine well pump for potable water.
Static water level and drawdown level updated 10/8/2015 based on
operational data and certified pump curve.
Pump to IX treatment and back to wet well

PUMP SYSTEM HEAD LOSS AND MOTOR CALCULATIONS

EQUATIONS:

- 1) Cross Sectional Area: $A = \pi * r^2$
 where: A = Cross sectional area (ft² or m²)
 r = radius (ft or m)

- 2) Velocity: $V = Q/A$
 where: V = Velocity (fps or m/s)
 Q = Flow (fps or m/s)

- 3) Velocity Head: $H_v = V^2/2g$
 where: g = 32.2 ft/sec² or 9.81 m/sec²

- 4) Pipe Friction Headloss: $H_f = L * S_f$
 where: S_f = Slope of energy grade line, (m/m or ft/ft)
 $S_f = (10.44 Q^{1.85}) / (C^{1.85} D^{4.8655})$ in english units or
 $S_f = (10.7 Q^{1.85}) / (C^{1.85} D^{4.8655})$ in metric units
 C = Coefficient of roughness
 D = Diameter of pipe, (in. or m)
 Q = flow (gpm or m³/s)
 head loss equation multiplier: 10.44
 motor hp calculation multiplier: 3960

- 5) Fitting Headloss: $H_f = K * H_v$ (all but reducers and increasers)

- 6) Increasers Headloss: $H_f = K * (\text{change in } H_v)$

- 7) Reducer Headloss: $H_f = K * (\text{change in } H_v)$

- 8) Design Static Head = (Discharge Water Surface (A)) - (Suction Wet Well High Level Elevation (A))
 Secondary Static Head = (Discharge Water Surface (B)) - (Suction Wet Well Water Surface Elevation (B))

- 9) Input Shaft Power: $P_s = (Q * TH) / (C_r * E)$
 where: Q = flow (gpm or m³/s)
 TH = total head of pump (ft or m)
 E = pump efficiency
 C_r = 3960 (English) or 0.102 (Metric)

- 10) Required Wetwell Storage Volume (gallons or m³): $V_w = (Q * T) / 4$
 where: Q = flow (gpm or m³/s)
 T = Motor Starting Criteria Time (minutes)

- 11) Control Elevation = V_w / A

ASSUMPTIONS:

- 1) Preliminary calculations are based on a pumping rate of 2,000 gpm _____
- 2) Maximum pump speed is 1,775 rpm _____
- 3) _____
- 4) _____
- 5) _____
- 6) _____

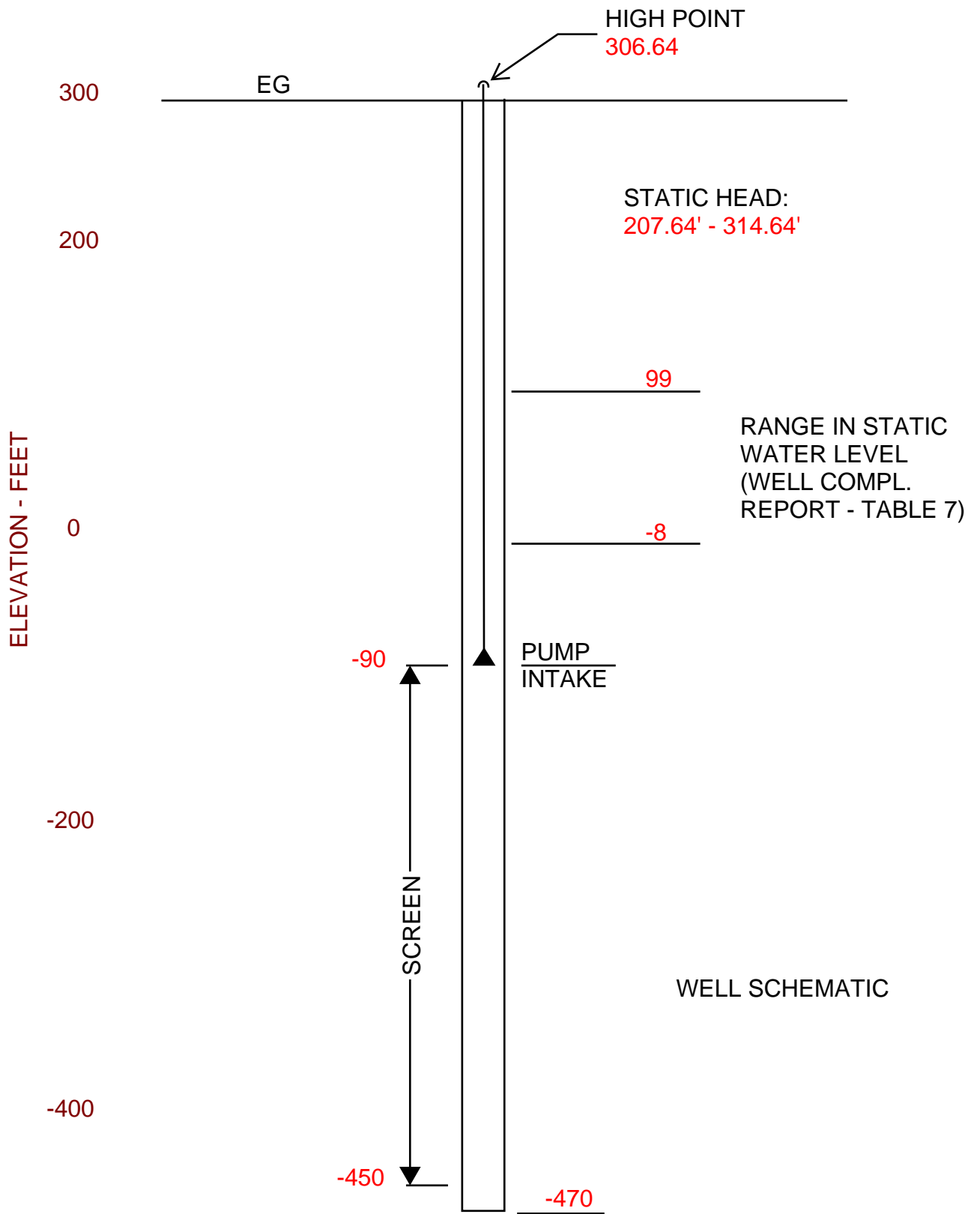

REQUIRED INPUT INFORMATION:

Shading indicates where data must be inputted.

UNITS:

Select the proper units, English or Metric. Enter all subsequent data according to the units specified.

Enter **E** for English Units or **M** for Metric Units:

FLOW:

Enter the discharge flow of the pump station and the number of duty pumps required to pump the design flow. The rated capacity of each pump will be calculated. If desired, the user can override this calculation by directly inputting a pump capacity. This capacity is used to calculate station losses.

Pump System Design Flow (Q):	2000.00	gpm (max. flow)
Number of Duty Pumps:	1	--
Pump Design Capacity:	2000.00	gpm

C-VALUES:

Enter the minimum and maximum C-Values for which System curves will be plotted. The minimum C-Value should be considered the design C-Value. It is recommended that the minimum C be 100 and the maximum C be 140 to provide an acceptable envelope of operation.

Min. Roughness Factor (C):	130	-- (Design Case)
Max. Roughness Factor (C):	140	--
Use Max or Min C for Max. Sys. Curve?	Min	
Gravity:	32.2	ft/s

WATER SURFACE ELEVATIONS:

Enter wetwell (pump suction) and discharge water surface elevations for the design case static head (A) and for a secondary static head (B). It is recommended that the wetwell high water level be used as the design case elevation.

A. Suction Side Water Elev.	-8.0	feet	Max. Static Head Condition (-8 ft at historical low water level)
A. Discharge Water Elev:	306.64	feet	(High point in pump piping at centerline of anti-siphon)
A. Static Head	314.64	feet	Max. Static Head Condition (307 ft @ Gooseneck - -8 ft at historical low water level)
A. Pumping Head	373.5	feet	Max. Pumping Head Condition (314.64 Static head + 58.8 ft Drawdown)
B. Suction Side Water Elev.	99.0	feet	Min. Static Head Condition (99 ft at historical high water level)
B. Discharge Water Elev:	306.64	feet	(High point in pump piping at centerline of anti-siphon)
B. Static Head	207.64	feet	Min. Static Head Condition (307 ft @ Gooseneck -99 ft at historical high water level)
B. Pumping Head	266.44	feet	Min. Pumping Head Condition (207.64 Static Head + 58.8 ft Drawdown)

HEADLOSS CALCULATIONS:

Input the required information into the headloss calculation tables below in the units specified. Additional rows can be added as necessary.
 Note: Only enter Pipe Length where required (e.g., for pipe losses, increasers/reducers).

STATION LOSSES (SUCTION SIDE OF PUMPS)

Item Description	INPUT DATA				FROM ABOVE		CALCULATED							
	Pipe Diam. D in	Pipe Length L ft	Fitting K Value	Qty.	For Increasers & Reducers Only:		Design C-Value	Flow Q gpm	(Eqn 1)	(Eqn 2)	(Eqn 3)	(increasers & reducers)	(Eqn4)	(Eqn 4)
					Upstream Diam. in	Dwnstrm Diam. in			Area A ft ²	Velocity V fps	Vel. Head Hv ft	dHv ft	Sf ft/ft	Head Loss HI ft
Engineered Suction	10	40	0.58	1			130	2000.00	0.55	8.17	1.04	---	0.0223517	0.89
Lineshaft Loss	12	416												5.82

Subtotal of Station Losses on Suction Side of Pump: **6.72 ft**

STATION LOSSES (DISCHARGE SIDE OF PUMPS)

Item Description	INPUT DATA				FROM ABOVE		CALCULATED							
	Pipe Diam. D in	Pipe Length L ft	Fitting K Value	Qty.	For Increases & Reducers Only:		Design C-Value	Flow Q gpm	(Eqn 1)	(Eqn 2)	(Eqn 3)	(increasers & reducers)	(Eqn4)	(Eqn 4)
					Upstream Diam. in	Downstream Diam. in			Area A ft ²	Velocity V fps	Vel. Head Hv ft	DHv ft	Sf ft/ft	Head Loss HI ft
Pipe Exit	12		0.50	1			130	2000.00	0.79	5.67	0.50	---	---	0.25
Silent Check Valve	12		2.95	1			130	2000.00	0.79	5.67	0.50	---	---	1.47
Tee In-Line	12		0.60	1			130	2000.00	0.79	5.67	0.50	---	---	0.30
BFV-150lb Class	12		0.35	1			130	2000.00	0.79	5.67	0.50	---	---	0.17
90 deg std radius	12		0.30	1			130	2000.00	0.79	5.67	0.50	---	---	0.15
Reducer	12		0.50	1	10	10	130	2000.00	0.79	5.67	0.50	0.00	---	0.00
Pipe loss	12	10		1			130	2000.00	0.79	5.67	0.50	---	0.0092056	0.09
Increaser	10		1.00	1	12	16	130	2000.00	0.55	8.17	---	0.34	---	0.34
Pipe loss	10	12		1			130	2000.00	0.55	8.17	1.04	---	0.0223517	0.27
BFV-150lb Class	16		0.35	1			130	2000.00	1.40	3.19	0.16	---	---	0.06
Pipe loss	16	3		1			130	2000.00	1.40	3.19	0.16	---	0.002	0.01
Tee main to branch	16		1.80	1	16	12	130	2000.00	1.40	3.19	---	0.34	---	0.62
Pipe loss	12	32		1			130	2000.00	0.79	5.67	0.50	---	0.009	0.29
90 deg std radius	12		0.30	1			130	2000.00	0.79	5.67	0.50	---	---	0.15
Pipe loss	16	42		1			130	2000.00	1.40	3.19	0.16	---	0.002	0.10
45 deg std radius	16		0.18	1			130	2000.00	1.40	3.19	0.16	---	---	0.03
Tee In-Line	16		0.60	1			130	2000.00	1.40	3.19	0.16	---	---	0.09
Pipe loss	16	17		1			130	2000.00	1.40	3.19	0.16	---	0.002	0.04
Diffuser (4" holes)	16		1.00	8			130	2000.00	1.40	3.19	0.16	---	---	1.27

Subtotal of Station Losses on Discharge Side of Pump: **5.70 ft**

Total Station Losses: **12.41 ft**

SYSTEM LOSSES - Force Main Yard Piping

Item Description	INPUT DATA				FROM ABOVE		CALCULATED							
	Pipe Diam. D in	Pipe Length L ft	Fitting K Value	Qty.	For Increases & Reducers Only:		Design C-Value	Flow Q gpm	(Eqn 1)	(Eqn 2)	(Eqn 3)	(increasers & reducers)	(Eqn4)	(Eqn 4)
					Upstream Diam. in	Downstream Diam. in			Area A ft ²	Velocity V fps	Vel. Head Hv ft	DHv ft	Sf ft/ft	Head Loss HI ft
Pipe loss	12	81		1			130	2000.00	0.79	5.67	0.50	---	0.0092056	0.75
Increaser	12		1.00	1	12	16	130	2000.00	0.79	5.67	---	0.34	---	0.34
Pipe loss	16	93		1			130	2000.00	1.40	3.19	0.16	---	0.0022707	0.21
Tee main to branch	16		1.80	1	16	12	130	2000.00	1.40	3.19	---	0.34	---	0.62
Pipe loss	12	24		1			130	2000.00	0.79	5.67	0.50	---	0.0092056	0.22
90 deg std radius	12		0.30	2			130	2000.00	0.79	5.67	0.50	---	---	0.30
Particulate Filters							---	---	---	---	---	---	---	34.59
Pipe loss	16	67		1			130	2000.00	1.40	3.19	0.16	---	0.0022707	0.15
90 deg std radius	16		0.30	2			130	2000.00	1.40	3.19	0.16	---	---	0.09
Tee branch to main	16		1.50	1			130	2000.00	1.40	3.19	0.16	---	---	0.24
Tee main to branch	16		1.80	1	16	12	130	2000.00	1.40	3.19	---	0.34	---	0.62
Pipe loss	16	5		1			130	2000.00	1.40	3.19	0.16	---	0.0022707	0.01
IX Vessels							---	---	---	---	---	---	---	32.28
Resin Fouling							---	---	---	---	---	---	---	23.06
Pipe loss	12	11		1			130	2000.00	0.79	5.67	0.50	---	0.0092056	0.10
BFV-150lb Class	12		0.35	1			130	2000.00	0.79	5.67	0.50	---	---	0.17
Tee branch to main	16		1.50	1			130	2000.00	1.40	3.19	0.16	---	---	0.24
Pipe loss	16	284		1			130	2000.00	1.40	3.19	0.16	---	0.0022707	0.64
90 deg std radius	16		0.30	5			130	2000.00	1.40	3.19	0.16	---	---	0.24
Static Wafer Mixer	16		13.63	2			130	2000.00	1.40	3.19	0.16	---	---	4.31
Diffuser (4" holes)	16		1.00	8			130	2000.00	1.40	3.19	0.16	---	---	1.27

System Losses: **100.45 ft**

Total Piping Losses (Station Losses and System Losses): **112.87 ft**

DESIGN PUMPING HEAD **373.46 ft**

TOTAL HEAD (TH): **486.33 ft**

PUMP RATED CAPACITY (Q): **2,000 gpm**

From input on Pump Data Sheet:
PUMP EFFICIENCY(e): **79.8 %**

Using Total Head (TH) to determine approximate motor size (Eqn 9),
INPUT SHAFT POWER (Ps): **307.80 HP**

K VALUES FOR VALVES , FITTINGS AND MINOR LOSSES

Use this reference table to obtain K values for input into the TH Worksheet.

ITEM	K Value
PIPE ENTRANCE & EXIT	
a. Flush entrance	0.50
b. Inward Projection	1.00
c. Slightly rounded entrance	0.25
d. Bellmouth	0.04
e. Exit (all)	1.00
TEES, WYES & ELBOWS	
a. Tees:	
Run of Main	0.60
Branch to Main	1.50
Main to Branch	1.80
b. Wyes:	
Run of Main	0.60
Branch to Main (Obtuse)	1.00
Main to Branch (Obtuse)	1.20
c. Elbows:	
Standard radius 90 deg	0.30
Long radius 90 deg	0.20
2-pc mitered 90 deg	1.10
5-pc mitered 90 deg (most common)	0.45
45 deg elbow	0.15
22 1/2 deg elbow	0.10

ITEM	K Value
VALVES	
a. Plug	1.00
b. Gate	0.10
c. Butterfly	0.40
d. Angle	2.00
e. Globe	12.00
f. Ball/Cone (line size)	0.05
e. Check Valves:	
Swing	2.50
Tilting Disk	0.40
FLOW METERS [Consult Instrumentation Engineer]	
a. Magnetic (line size)	0.00
b. Venturi (Approx 5 to 10% of pressure differential)	
c. Orifice (Application dependent...See Instr. Engr)	
REDUCERS & INCREASERS	
a. Reducer	0.50
b. Increaser	1.00
(minor loss equals $K^* (Hv1-Hv2)$ and v1 is the higher velocity)	

SYSTEM CURVE DATA CALCULATIONS

This sheet does not require modification or input by the user.

ALTERNATIVE 2a

Results from Design Case Calculations		
Roughness Factor (C):	130	---
Number of Pumps:	1	---
Flow (Q):	2000.00	gpm
Roughness Coefficient (C):	130	---
Maximum Static Head (H _s):	314.64	feet
Minimum Static Head (H _s):	207.64	feet
Friction Loss (H _f):	100.45	feet
Station Loss (H _{sta}):	12.41	feet

Data for System Curves							
		MAX. SYSTEM HEAD			MIN. SYSTEM HEAD		
		SELECTED ROUGHNESS COEFFICIENT: C = 130			SELECTED ROUGHNESS COEFFICIENT: C = 130		
%Q _R	Q gpm	H _s ft	H _f ft	TDH ft	H _s ft	H _f ft	TDH ft
0	0	314.64	0.00	314.64	207.64	0.00	207.64
10%	200	314.64	1.59	322.12	207.64	1.59	215.12
20%	400	314.64	5.75	332.15	207.64	5.75	225.15
30%	600	314.64	12.17	344.46	207.64	12.17	237.46
40%	800	314.64	20.72	358.89	207.64	20.72	251.89
50%	1000	314.64	31.31	375.36	207.64	31.31	268.36
60%	1200	314.64	43.87	393.80	207.64	43.87	286.80
70%	1400	314.64	58.34	414.16	207.64	58.34	307.16
80%	1600	314.64	74.69	436.39	207.64	74.69	329.39
90%	1800	314.64	92.88	460.46	207.64	92.88	353.46
100%	2000	314.64	112.87	486.33	207.64	112.87	379.33
110%	2200	314.64	134.63	513.98	207.64	134.63	406.98
120%	2400	314.64	158.14	543.37	207.64	158.14	436.37
130%	2600	314.64	183.38	574.49	207.64	183.38	467.49
140%	2800	314.64	210.33	607.32	207.64	210.33	500.32
150%	3000	314.64	238.96	641.84	207.64	238.96	534.84

Notes:

- Friction losses equal station losses plus system losses for single duty pump designs. For multiple pump designs, station losses are not included in the above table; they are accounted for in the modified pump curves shown in the (Pump Curve--Multiple) worksheet.

2. Well Drawdown based on short-term well specific capacity of 40 GPM/FT. Assume long term is reduced by 15%.

Well Drawdown²		
Q	Short Term	Long Term
gpm	ft	ft
0	0.00	0.00
200	5.00	5.88
400	10.00	11.76
600	15.00	17.65
800	20.00	23.53
1000	25.00	29.41
1200	30.00	35.29
1400	35.00	41.18
1600	40.00	47.06
1800	45.00	52.94
2000	50.00	58.82
2200	55.00	64.71
2400	60.00	70.59
2600	65.00	76.47
2800	70.00	82.35
3000	75.00	88.24

PUMP CURVE DATA SHEET

ALTERNATIVE 2a

Notes: Impeller material shall be stainless steel.

Manufacturer's Pump Curve Data:

Pump Description: **Flowsolve 15EMM 5-stage VTP, 300 HP constant speed motor**

	Flow		Total Head		Plot - Single Pump
Min. Flow	1,000	gpm	581.9	ft	0 268.4
Design Condition	2,000	gpm	486.9	ft	
Max. Flow	2,500	gpm	380.8	ft	0 543.4

Flow (gpm)	Total Design Head (ft)
0 gpm	672.1 ft
250 gpm	640.0 ft
500 gpm	615.4 ft
750 gpm	598.2 ft
1000 gpm	581.9 ft
1250 gpm	565.3 ft
1500 gpm	550.1 ft
1750 gpm	521.5 ft
2000 gpm	486.9 ft
2250 gpm	442.3 ft
2500 gpm	380.8 ft
2713 gpm	322.3 ft

SYSTEM CURVE DATA			
C = 130		C = 130	
FLOW	HEAD	FLOW	HEAD
0	314.64	0	207.64
200	322.12	200	215.12
400	332.15	400	225.15
600	344.46	600	237.46
800	358.89	800	251.89
1000	375.36	1000	268.36
1200	393.80	1200	286.80
1400	414.16	1400	307.16
1600	436.39	1600	329.39
1800	460.46	1800	353.46
2000	486.33	2000	379.33
2200	513.98	2200	406.98
2400	543.37	2400	436.37
2600	574.49	2600	467.49
2800	607.32	2800	500.32
3000	641.84	3000	534.84

STATION LOSSES	
FLOW	HEAD
0.00	Long Term
0.00	ft
0.00	0.00
0.00	5.88
0.00	11.76
0.00	17.65
0.00	23.53
0.00	29.41
0.00	35.29
0.00	41.18
0.00	47.06
0.00	52.94
0.00	58.82

Pump rated speed: **1775** rpm
 Pump reduced speed: **1775** rpm
 % speed: **100%**

Pump efficiency: **79.8** %

No. of pumps: **1**

Series (S) or Parallel (P): **P**

Show Variable Speed Curves
 for Pump No. 1 (Y/N): **N**

IRWD OPA Pump Station System Curve Alternative 2a

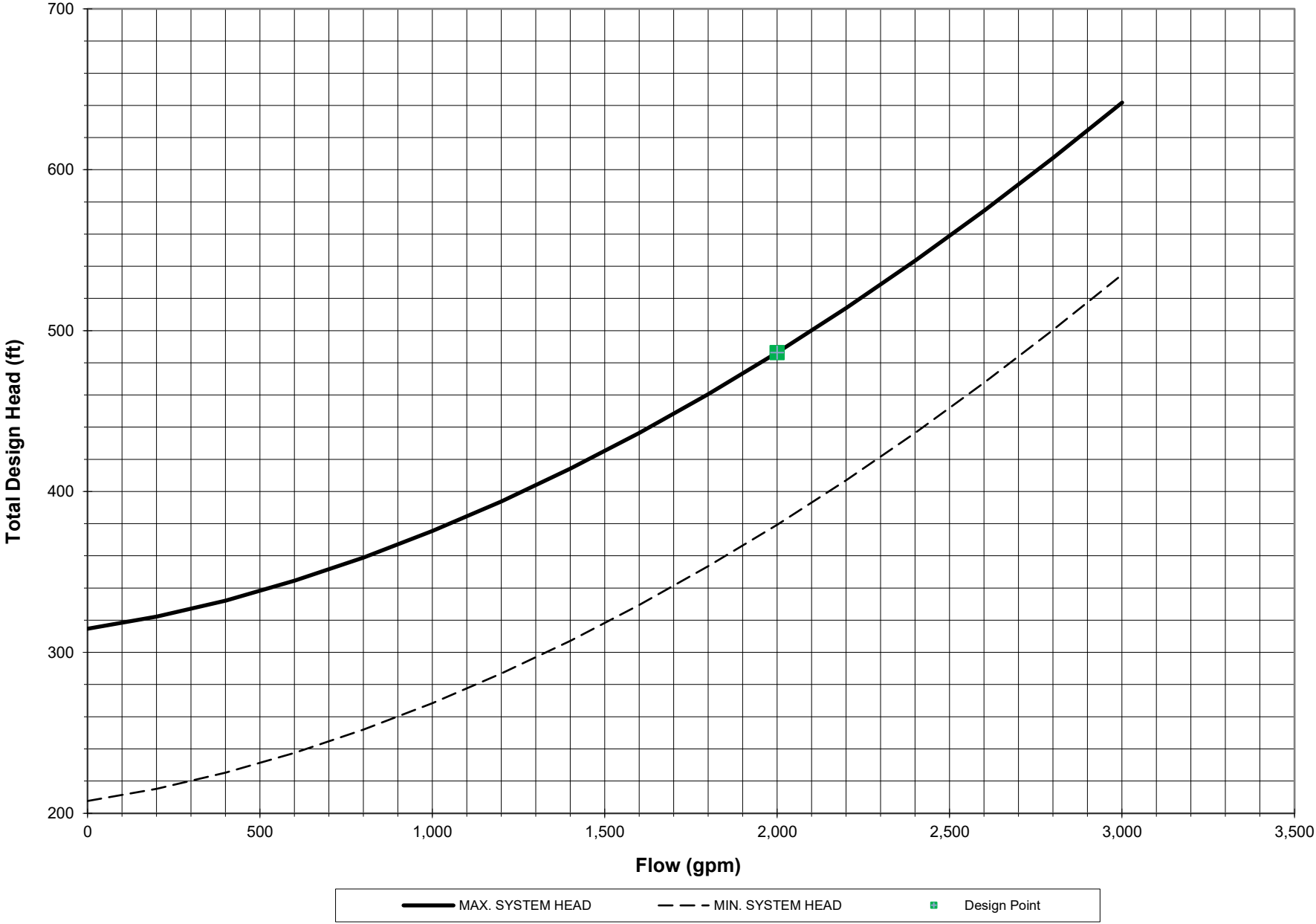

IRWD OPA Pump Station Alternative 2a- OPA-1 Well Pump Selection

Model: Flowsolve 15EMM 5-stage VTP, 300 HP constant speed motor

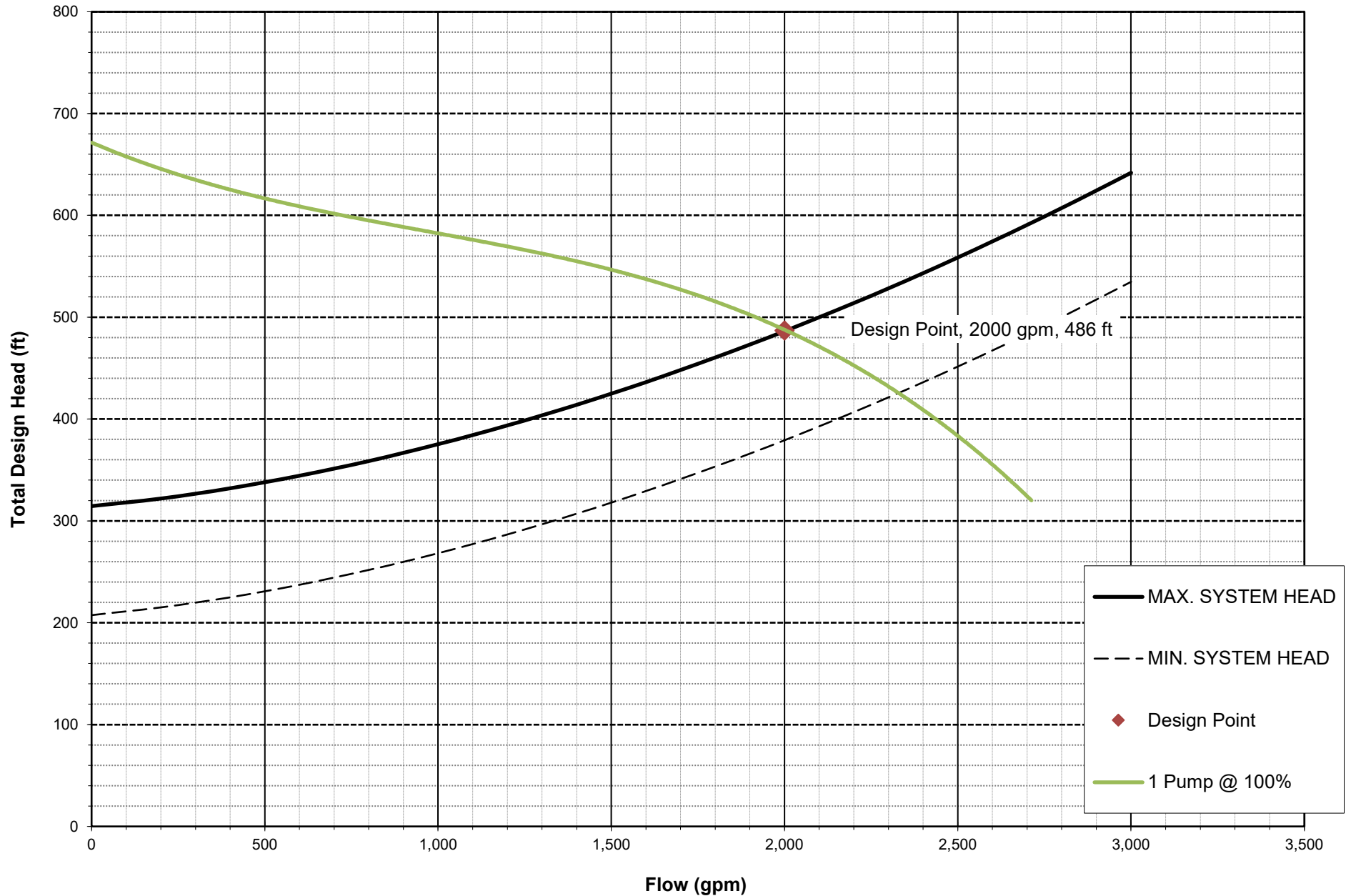

NET POSITIVE SUCTION HEAD (NPSH) INVESTIGATION

Sufficient positive suction head must be available at the eye of a centrifugal pump to satisfy the tested need for such head or pressure to prevent the pump from cavitating. The key is to provide all potential vendors sufficient information so that they are fully informed of project conditions.

$$\text{NPSH}_a = H_{\text{bar}} + H_{\text{stat}} - H_{\text{vap}} - H_f - \text{SF}$$

where:

NPSH_a = Net Positive Suction Head Available

H_{bar} = Barometric Pressure

H_{stat} = Static Suction Head

H_{vap} = Fluid Vapor Pressure

H_f = Suction Friction Losses

SF = Safety Factor

Input the following information:

Altitude:	<input type="text" value="302"/>	ft
Water Temperature:	<input type="text" value="60"/>	F
Min. static GW elev.	<input type="text" value="-66.82"/>	ft
Pump intake elev.	<input type="text" value="-119"/>	ft
Safety Factor:	<input type="text" value="5.0"/>	ft
Atmospheric Pressure:	33.90 ft	(From Table below)
Specific Gravity:	0.999	(From Table below)
Barometric Pressure:	33.934 ft	
Static Suction Head:	52.18 ft	
Fluid Vapor Pressure:	0.590 ft	(From Table below)
Suction Friction Losses:	6.72 ft	

NPSH Available:	73.8	feet
------------------------	-------------	-------------

Storm Drain Capacity Calculations

Gravity-fed Pipe Flow

Inputs:

Pipe Diameter, D:	12 in	Hazen Williams Equations Inputs		
Depth of flow, y:	12 in	Hazen Williams Roughness Coefficient, C:	140	k = 1.318 for US customary units, k = 0.849 for SI units
Material:	Concrete	Conversion Factor, k:	1.318	
Pipe Length, L:	53.4 ft	Mannings Equations Inputs		
Pipe Elevation Drop, H:	1.666667 ft	Mannings Roughness coefficient, nfull:	0.011	kn = 1.486 for US customary units, kn = 1.0 for SI units
		Conversion Factor, kn:	1.486	

Calculated Outputs:

Pipe Diameter, D:	1 ft	Hazen Williams Outputs		
Depth of Flow, y:	1 ft	Flow velocity, v:	11.84873 ft/s	
Pipe flow ratio, y/D:	1	Flow Discharge, Q:	9.305969 cfs	
Radius, r:	0.5 ft	Flow Discharge, Q:	4176.808 gpm	
Slope, S:	0.031211	Mannings Outputs		
Circular Segment Height, h:	0 ft	Flow velocity, v:	9.471233 ft/s	
Cross sectional area of flow, A:	0.785398 sq ft	Flow Discharge, Q:	7.438689 cfs	
Central Angle, θ :	0 deg	Flow Discharge, Q:	3338.715 gpm	
Wetted Perimeter, P:	3.141593 ft			
Hydraulic Radius, R:	0.25 ft			

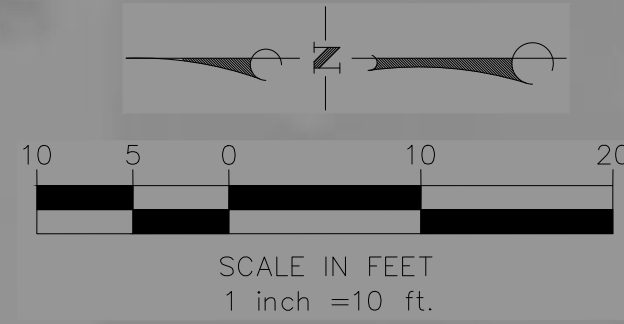

NOTE:
BACKGROUND IMAGE IS FROM GOOGLE
EARTH AND IS FOR REFERENCE ONLY.

NO BACKGROUND HAS BEEN PROVIDED BY
CLIENT. ONCE BACKGROUND IS PROVIDED
UTILITY MAP WILL BE UPDATED

SEE SHEET 1 FOR ABBREVIATIONS, LINE/
SYMBOL LEGENDS, KEY NOTES AND UTILITY
NOTES

N. GRAVIER STREET

E. BOND AVENUE

PROSPECT STREET

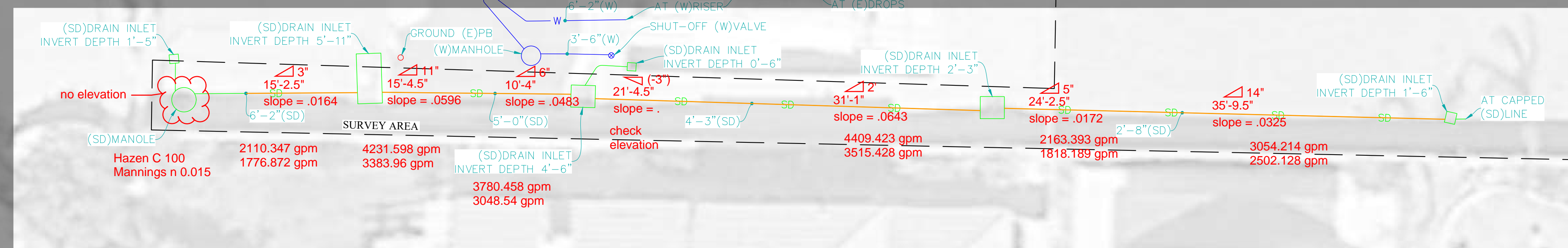
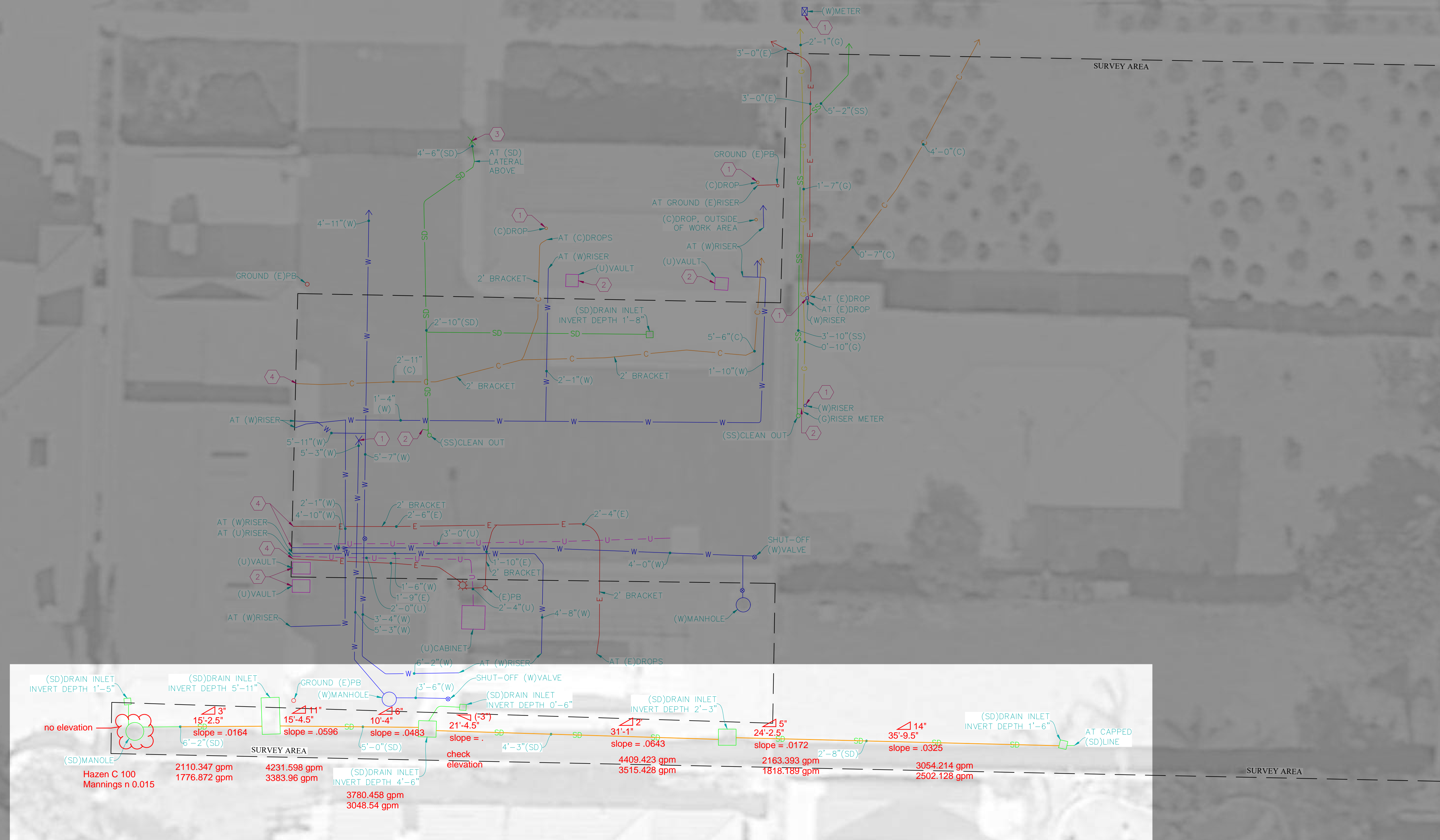

C BELOW SUBSURFACE IMAGING
14280 EUCLID AVE
CHINO, CA 91710
P: 888-902-3569
F: 909-606-6555
www.cbelow.com

NOTES: The services provided by C Below, Inc. do not relieve the Client and/or property owner of the responsibility of having to comply with California Government Code §54216-4216.9. It is expressly understood by the Client and/or owner that CBSI services are not a substitute for compliance with California Code §54216-4216.9.

PROJECT:
PARTIAL UNDERGROUND UTILITY MAP FOR:
IRVINE RANCH WATER DISTRICT
678 N. GRAVIER STREET
ORANGE, CA 92868

CLIENT:
AECOM
999 TOWN AND COUNTRY ROAD
ORANGE, CA 92868

REVISIONS			
NO	DATE	BY	DESCRIPTION

DATE LOCATED: 2/2021
DRAWN BY/DATE: LB 2/26/2021
TECHNICIAN: B. TRAHAN
CHECK BY/DATE: A. LOPEZ
QC CHECKED BY/DATE: OG 3/01/2021
DRAWING NAME: UTILITY MAP
PROJECT NO: 20-3097
SCALE: 1" = 10'
SHEET 2 OF 2

HVAC Calculations

PUMP INFO

EXIST. PUMP	250 HP	EFFICIENCY:	95.4%
NEW PUMP	350 HP	EFFICIENCY:	95.4%

EXISTING DESIGN AIR FLOW RATES

ELECTRICAL ROOM			PUMP ROOM		
AC SUPPLY FAN	=	2400 CFM	EXHAUST FAN	=	8000 CFM
EXHAUST FAN	=	1000 CFM			
AC EXHAUST FAN	=	7000 CFM			
TOTAL EXHAUST	=	8000 CFM	TOTAL EXHAUST	=	8000 CFM

AIR CONDITIONER COOLING CAPACITY

GROSS COOLING	=	124100 BTU/H	124.1 MBH
SENSIBLE COOLING	=	36200 BTU/H	36.2 MBH

SWITCHGEAR HEAT LOSSES

HORSE POWER	WATTAGE	ENERGY UNITS	
250 HP	380 W	1295.8 BTU/H	1.2958 MBH
350 HP	472 W	1609.52 BTU/H	1.60952 MBH
Δ 250 HP TO 350 HP	=> 92 W	313.72 BTU/H	0.31 MBH

1W = 3.41 BTU/H
1MBH = 1000 BTU/H

NEGLIGIBLE CHANGE IN HEAT

ELEC. ROOM CHANGE IN TEMP => ΔT 250HP to 350 HP = (BTU/H)/(1.08*CFM) = 0.036310185 MBH NEGLIGIBLE CHANGE IN TEMPERATURE

PUMP MOTOR HEAT LOSSES

	MAX BHP	MAX WATTAGE	HEAT LOSS UNITS
NEW PUMP	319 HP =	238.1 kW	37345.3 BTU/H
EXIST. PUMP	239 HP =	178.4 kW	27979.7 BTU/H
CHANGE	80 HP =	59.7 kW	9365.6 BTU/H

ASHRAE Classifies heat gain into (3) as follows:

	NEW	EXIST.	CHANGE	UNITS
A = Motor in Driven Equip in. Btu/hr Heat gain = (BHP x 2545)/Eff	851001.0	637583.9	213417.2	BTU/H (A)
B = Motor out, Driven Equip in. Btu/hr Heat Gain = BHP x 2545	811855.0	608255.0	203600.0	BTU/H (B)
C = Motor in, Driven Equip out. Btu/hr Heat Gain = (1/Eff -1) x BHP x 2545	39146.0	29328.9	9817.2	BTU/H (C)
PUMP ROOM CHANGE IN TEMP => ΔT = (BTU/H)/(1.08*CFM) =	4.5	3.4	1.1	°F (ΔT)
PUMP ROOM CHANGE IN TEMP => ΔT 250HP to 350 HP = (BTU/H)/(1.08*CFM) =	1.1	ΔT		NEGLIGIBLE CHANGE IN TEMPERATURE

DESIGN OUTDOOR AIR TEMP	94 °F
TYPICAL MAX RATING FOR MOTORS	104 °F
ALLOWABLE ROOM TEMP INCREASE	10 °F

	NEW	EXIST	CHANGE
REQ'D CFM OA	3624.6 CFM	2715.6 CFM	909.0 CFM

Appendix I: Cost Evaluation

**Opinion of Probable Construction Cost
30% Design Submittal**

Project name	21-028 OCWD Wellhead-30% IRWD Orange Park Acres Orange Park Acres CA 92869 USA
Client	OCWD
Architect	AECOM
Engineer	AECOM
Document	60648259-OPA1PFAS-PRELIM
Estimator	Mark McClenahan, CPE
Labor rate table	1 AECOM RATES 21
Equipment rate table	Equip - ACM 21ld wrk
Job size	2000 gpm
Project	Wellhead Treatment
Bus Line	Water
Section	SW USA
Office	Orange Co., CA
Principal Party	Alex Franchi
Estimating Office	Latham, NY
Contract 1	Mark McClenahan
Contract 2	Martin Hammer
Estimate Class Lvl	Class 3
Estimate Purpose	Design Development
FY Estimate	2021
Estimate Number	21-028
Start Date	TBD
LD's	TBD
P&S documentation	February 2021
Notes	<p><i>ENGINEER'S OPINION OF PROBABLE CONSTRUCTION COSTS 30% DESIGN SUBMITTAL Costs at 30, 60, 90 and 100%. This is for a wellhead treatment (2,000 gpm) under canopy + electrical Project: Irvine Ranch Water District (IRWD) Orange Park Acres Well No. 1 Wellhead facilities PFAS Treatment System Client: Orange County Water District (OCWD) Scope: Site demolition (there is a townhouse on the project site that needs to be demolished) Construction of a 10-foot deep pit for ion exchange vessels (cost includes installation of vessels only – they are prepurchased by the client) Outdoor installation of bag filters Pipelines to a from the IX vessels Upgrade of exiting well pump (quote enclosed) Piping upgrade inside the pump station Electrical upgrades</i></p> <p><i>IX Filters procured and furnished by owner per Evoqua Proposal #2001-210.R2 Assumptions: Vendor to Furnish and Deliver to job site (4) HP(r) 1220CIX SYS Pressure Vessels 12' diam x 16'-4" high, all loose instruments, interconnecting piping, valves and instruments, control panels and media. Contractor to receive, unload, assemble and install pressure vessels and apputrenances provided by vendor.</i></p>

Opinion of Probable Construction Cost
30% Design

*All vessel internals including media furnished and installed by vendor.
Vendor to furnish submittals, O&M Manuals, manufacturer services
and support for testing, start-up, and commissioning and owner training.*

*Revision 01, 02April2021:
Corrections per Alex Franchi
Adjusted quantity of excavation for Vessels Pit
Pipe diameter changed from 12" to 16" where noted on pdf.*

*Engineering Opinion of Probable Cost disclaimer:
"The enclosed Engineer's Estimate is only an estimate of possible
construction costs for budgeting purposes. This estimate is limited to
the conditions existing at its issuance and is not a guaranty of actual
price or cost. Uncertain market conditions such as, but not limited to:
local labor or contractor availability, wages, other work, material
market fluctuations, price escalations, force majeure events, and
developing bidding conditions etc may affect the accuracy of this
estimate. AECOM is not responsible for any variance from this
estimate or actual prices and conditions obtained."*

Report format

Sorted by 'WBS Lvl 1/WBS Lvl 2/WBS Lvl 3'
'Detail' summary

Opinion of Probable Construction Cost
30% Design

WBS Lvl 1	WBS Lvl 2	WBS Lvl 3	Description	Takeoff Quantity	Labor Amount	Material Amount	Sub Amount	Equip Amount	Other Amount	Total Cost/Unit	Total Amount	Addon Amount	Grand Total Price
Alt 6			Alternative 6										
	1		Mobilization										
		* unassigned *											
			General Contractor - Mobilization / Demobilization & Cleanup	1.00 ls	-		0	-	-	0.01 /ls	0	67,942	67,941.94 /ls
			* unassigned *				0				0	67,942	
			1 Mobilization	1.00 ls			0			0.01 /ls	0	67,942	67,941.94 /ls
	2		Site Demolition										
		* unassigned *											
			Demo Wood framed structure (house)	16,000.00 cf	-	-	12,000	-	-	0.75 /cf	12,000	11,505	1.47 /cf
			Clear and Grub Site -Light	0.25 ac	262	-	-	94	-	1,424.56 /ac	356	298	2,615.88 /ac
			Strip Topsoil to Stockpile	122.22 cy	223	-	-	210	-	3.54 /cy	433	366	6.54 /cy
			Rough Grade Balance of Site	1,111.11 sy	2,249	-	-	122	-	2.13 /sy	2,371	1,959	3.90 /sy
			* unassigned *				12,000				426	15,160	14,129
			2 Site Demolition	1.00 ls	2,734		12,000	426		15,160.33 /ls	15,160	14,129	29,289.03 /ls
	3		Site Work										
		* unassigned *											
			Demo Mech. Equipment - 12" SS Static Mixer (Sodium Hypo/Ammonia Inkection) plus injectors - relocate	1.00 ls	741	-	-	-	-	741.42 /ls	741	611	1,352.19 /ls
			Demo Mech. Equipment - 16" Antisiphon "Goose Neck" and ARV	1.00 ls	1,483	-	-	-	-	1,482.85 /ls	1,483	1,222	2,704.37 /ls
			Demo CS Pipe 16"	1.00 ls	689	-	-	-	-	689.22 /ls	689	568	1,256.97 /ls
			Bollards 4"- concrete filled	6.00 ea	1,911	3,000	-	-	-	818.57 /ea	4,911	4,173	1,514.12 /ea
			Sidewalks 5"	270.00 sf	810	1,080	-	-	-	7.00 /sf	1,890	1,603	12.94 /sf
			Fine Grade Balance of Site	1,800.00 sy	1,465	-	-	772	-	1.24 /sy	2,237	1,879	2.29 /sy
			Excavate per Cu/Yard - Vessels Pit 41' x 50' x 10 ft deep, laid back 1:1 slope	2,314.07 cy	37,783	-	-	7,967	-	19.77 /cy	45,750	38,065	36.22 /cy
			Excavate per Cu/Yard - Prefilters and Antisiphon	20.00 cy	327	-	-	69	-	19.77 /cy	395	329	36.22 /cy
			Fill Earth Stockpile - Dozer/Compactor - Backfill IX Vessels Pit	1,554.74 cy	2,847	44,466	-	2,437	-	32.00 /cy	49,749	42,987	59.65 /cy
			Fill Earth Stockpile - Dozer/Compactor - Backfill Filters/Antisiphon	5.00 cy	9	143	-	8	-	32.00 /cy	160	138	59.65 /cy
			Site Fill Stone-Dozer - 12" under slab, 2' walls	245.93 cy	1,918	6,954	-	1,246	-	41.14 /cy	10,118	8,689	76.47 /cy
			Site Fill Stone-Dozer - 12" under slab, 2' walls	5.00 cy	39	141	-	25	-	41.14 /cy	206	177	76.47 /cy
			Gravel Base - Sidewalks	140.00 cy	684	6,006	-	585	-	51.96 /cy	7,275	6,276	96.79 /cy
			Stone Base - Roads	138.89 cy	678	3,750	-	580	-	36.06 /cy	5,009	4,313	67.11 /cy
			Bituminous Base Course 2"	833.33 sy	-	-	8,333	-	-	10.00 /sy	8,333	7,990	19.59 /sy
			Bituminous Binder Course 2"	833.33 sy	-	-	8,333	-	-	10.00 /sy	8,333	7,990	19.59 /sy
			Bituminous Top Course 2"	833.33 sy	-	-	10,000	-	-	12.00 /sy	10,000	9,588	23.51 /sy
			Concrete Paving 6"	180.00 sy	126	6,369	-	548	-	39.13 /sy	7,043	6,098	73.01 /sy
			Concrete Ramp 6"	60.00 sy	42	2,123	-	183	-	39.13 /sy	2,348	2,033	73.01 /sy
			Concrete Curb & Gutter, slip-form	325.00 lf	-	-	4,875	-	-	15.00 /lf	4,875	4,674	29.38 /lf
			6' Fence Vehicle Gate 16'	1.00 ea	-	-	6,500	-	-	6,500.00 /ea	6,500	6,232	12,731.96 /ea
			Xeriscaped Landscape	2,000.00 sf	-	-	10,000	-	-	5.00 /sf	10,000	9,588	9.79 /sf
			* unassigned *		51,551	74,032	48,042	14,420			188,045	165,221	
			3 Site Work	1.00 ls	51,551	74,032	48,042	14,420		188,044.71 /ls	188,045	165,221	353,265.21 /ls
	4		Yard Piping, Mech Piping, Fittings & Valves										
		10-inch Waste	10-inch Well Pump Discharge & Waste lines										
			Gasket/Nuts/Bolt Kit 10"	10.00 ea	463	375	-	-	-	83.87 /ea	839	707	154.55 /ea
			Stainless Nuts & Bolts 10" Gr. B8	10.00 ea	334	1,986	-	-	-	231.92 /ea	2,319	1,995	431.42 /ea
			CS Sch 40 A53 ERW PE 10"	4.00 lf	114	232	-	-	-	86.37 /lf	345	294	159.98 /lf
			CS Std Wt 90- EII LR 10	4.00 ea	1,809	1,501	-	-	-	827.60 /ea	3,310	2,791	1,525.29 /ea
			Flange WN 300 FF Sch 40 10	10.00 ea	3,524	4,086	-	-	-	760.95 /ea	7,610	6,442	1,405.16 /ea
			IB BFV Lever Hdl Flg Wafer 10"	1.00 ea	158	1,875	-	-	-	2,032.66 /ea	2,033	1,754	3,786.77 /ea
			IB N/Slam Wfr Chk 125# Flg 10" - double check	2.00 ea	360	1,958	-	-	-	1,158.94 /ea	2,318	1,993	2,155.24 /ea
			10-inch Waste 10-inch Well Pump Discharge & Waste lines	4.00 lf	6,761	12,013				4,693.47 /lf	18,774	15,976	8,687.39 /lf
		12-inch CM/C CS	12-inch Cement Mortar Lined and Coated Steel Pipe										
			Paint 12" Pipe - Epoxy Coated	250.00 lf	2,995	1,236	-	2,331	-	26.25 /lf	6,563	5,569	48.53 /lf
			Paint 12" Pipe - Epoxy Coated	60.00 lf	719	297	-	559	-	26.25 /lf	1,575	1,337	48.53 /lf
			Stainless Nuts & Bolts 12" Gr. B8	23.00 ea	921	4,384	-	-	-	230.65 /ea	5,305	4,556	428.75 /ea
			CS Sch 40 A53 ERW PE 12"	250.00 lf	8,400	17,736	-	-	-	104.54 /lf	26,135	22,283	193.67 /lf
			CS Sch 40 A53 ERW PE 12"	60.00 lf	2,016	4,257	-	-	-	104.54 /lf	6,273	5,348	193.67 /lf
			CS Std Wt 45- EII LR 12	10.00 ea	5,178	2,763	-	-	-	794.07 /ea	7,941	6,659	1,459.94 /ea
			CS Std Wt 90- EII LR 12	10.00 ea	5,578	5,535	-	-	-	1,111.33 /ea	11,113	9,390	2,050.33 /ea
			CS Std Wt Tee 12	4.00 ea	3,244	2,448	-	-	-	1,423.12 /ea	5,692	4,793	2,621.44 /ea
			CS Std Wt Tee 12	3.00 ea	2,433	1,836	-	-	-	1,423.12 /ea	4,269	3,595	2,621.44 /ea
			CS Std Wt Cap 12	2.00 ea	519	30,542	-	-	-	15,530.52 /ea	31,061	26,885	28,972.96 /ea
			Flange 300 Blind FF 12	2.00 ea	451	1,661	-	-	-	1,056.37 /ea	2,113	1,811	1,961.87 /ea
			Flange WN 300 FF Sch 40 12	4.00 ea	1,763	2,514	-	-	-	1,069.27 /ea	4,277	3,630	1,976.80 /ea
			Interior Lining of Pipe, Shop Applied FPE	785.00 sf	-	-	2,748	-	-	3.50 /sf	2,748	2,634	6.86 /sf
			Interior Lining of Pipe, Shop Applied Cement Mortar	189.00 sf	-	-	662	-	-	3.50 /sf	662	634	6.86 /sf
			Interior Lining of Fittings 8"-14", Shop Applied - FPE	24.00 ea	-	-	960	-	-	40.00 /ea	960	920	78.35 /ea

Opinion of Probable Construction Cost
30% Design

WBS Lvl 1	WBS Lvl 2	WBS Lvl 3	Description	Takeoff Quantity	Labor Amount	Material Amount	Sub Amount	Equip Amount	Other Amount	Total Cost/Unit	Total Amount	Addon Amount	Grand Total Price
		12-inch CM/C CS	12-inch Cement Mortar Lined and Coated Steel Pipe										
			Interior Lining of Fittings 8"-14", Shop Applied - Cement Mortar	3.00 ea	-	-	120	-	-	40.00 /ea	120	115	78.35 /ea
			12-inch CM/C CS 12-inch Cement Mortar Lined and Coated Steel Pipe	310.00 lf	34,218	75,209	4,489	2,890		376.79 /lf	116,806	100,160	699.89 /lf
		12-inch FPE CS	12-inch Fusion Epoxy lined and painted Steel Pipe										
			Gasket/Nuts/Bolt Kit 12"	23.00 ea	1,066	1,035	-	-	-	91.34 /ea	2,101	1,775	168.49 /ea
			IB BFV Lever Hdl Flg Wafer 12"	4.00 ea	681	9,700	-	-	-	2,595.15 /ea	10,381	8,963	4,835.99 /ea
			12-inch FPE CS 12-inch Fusion Epoxy lined and painted Steel Pipe	250.00 lf	1,746	10,735				49.93 /lf	12,481	10,738	92.88 /lf
		16-inch FPE CS	16-inch Fusion Epoxy lined and painted Steel Pipe										
			Paint 16" Pipe - epoxy coated	250.00 lf	3,495	1,649	-	2,497	-	30.56 /lf	7,640	6,482	56.49 /lf
			CS Sch 40 A53 ERW PE 16"	250.00 lf	10,231	22,394	-	-	-	130.50 /lf	32,624	27,826	241.80 /lf
			CS Std Wt 45- EII LR 16	10.00 ea	7,030	4,545	-	-	-	1,157.50 /ea	11,575	9,728	2,130.32 /ea
			CS Std Wt 90- EII LR 16	10.00 ea	7,711	9,270	-	-	-	1,698.06 /ea	16,981	14,382	3,136.25 /ea
			CS Std Wt Tee 16	4.00 ea	4,444	3,708	-	-	-	2,037.93 /ea	8,152	6,873	3,756.09 /ea
			CS Std Wt Cap 16	2.00 ea	697	470	-	-	-	583.39 /ea	1,167	981	1,073.94 /ea
			Flange 300 Blind FF 16	2.00 ea	604	2,649	-	-	-	1,626.52 /ea	3,253	2,792	3,022.66 /ea
			Flange WN 300 FF Sch 40 16	4.00 ea	2,428	4,490	-	-	-	1,729.44 /ea	6,918	5,889	3,201.79 /ea
			Interior Lining of Pipe, Shop Applied Cement Mortar	1,047.38 sf	-	-	3,666	-	-	3.50 /sf	3,666	3,515	6.86 /sf
			Interior Lining of Fittings 8"-14", Shop Applied - Cement Mortar	24.00 ea	-	-	1,440	-	-	60.00 /ea	1,440	1,381	117.53 /ea
			16-inch FPE CS 16-inch Fusion Epoxy lined and painted Steel Pipe	250.00 lf	36,638	49,174	5,106	2,497		373.66 /lf	93,415	79,849	693.06 /lf
		8-inch PVC SDR 35	8-inch PVC SDR 35 Sewer Line										
			Trench Excav & Lay Pipe 0- 4'	260.00 lf	2,663	-	-	684	-	12.87 /lf	3,347	2,790	23.60 /lf
			CY Trench Excavation (Volume Calculation Only)	141.36 cy	-	-	-	-	-	/cy	-	-	/cy
			Utility Bed Peastone	17.67 cy	101	505	-	97	-	39.83 /cy	704	606	74.11 /cy
			Utility Cover Peastone	14.31 cy	82	409	-	79	-	39.83 /cy	570	491	74.11 /cy
			Spoils to Waste	35.34 cy	191	-	-	86	-	7.82 /cy	276	232	14.37 /cy
			Backfill Trench-Backhoe/Truck	109.38 cy	610	-	-	243	-	7.80 /cy	853	714	14.33 /cy
			PVC SDR 35 8	260.00 lf	1,568	2,496	-	-	-	15.63 /lf	4,064	3,454	28.91 /lf
			8-inch PVC SDR 35 8-inch PVC SDR 35 Sewer Line	260.00 lf	5,215	3,411		1,188		37.75 /lf	9,814	8,286	69.62 /lf
		Chem Injection	Double-containment Chemical Piping										
			Fiberglass Pipe 2"	90.00 lf	310	450	-	-	-	8.45 /lf	760	645	15.62 /lf
			Fiberglass Pipe 45 Ells 2"	4.00 ea	169	60	-	-	-	57.22 /ea	229	191	104.98 /ea
			Fiberglass Pipe 90 Ells 2"	4.00 ea	169	60	-	-	-	57.22 /ea	229	191	104.98 /ea
			Fiberglass Pipe Tees 2"	2.00 ea	125	50	-	-	-	87.46 /ea	175	146	160.57 /ea
			FRP Containment Pipe 4"	90.00 lf	465	1,485	-	-	-	21.67 /lf	1,950	1,670	40.22 /lf
			FRP Containment 90 ells 4"	4.00 ea	920	301	-	-	-	305.38 /ea	1,222	1,019	560.14 /ea
			FRP Containment 45 ells 4"	4.00 ea	918	301	-	-	-	304.95 /ea	1,220	1,018	559.35 /ea
			FRP Containment Couplings 4"	20.00 ea	4,592	1,463	-	-	-	302.75 /ea	6,055	5,050	555.24 /ea
			FRP Containment Tees 4"	2.00 ea	689	187	-	-	-	438.11 /ea	876	730	802.98 /ea
			Static Mixer - 316L SS - install only w/ Chemical Injection lances	1.00 ea	345	50	-	-	-	394.61 /ea	395	327	721.82 /ea
			Chem Injection Double-containment Chemical Piping	90.00 lf	8,702	4,408				145.67 /lf	13,110	10,987	267.74 /lf
		PC Vaults	Precast Concrete Vaults										
			4'x4'x6' - 6" thick Precast Vault for 16" Valve	2.00 ea	2,404	2,690	-	998	-	3,045.90 /ea	6,092	5,180	5,635.84 /ea
			4'x4'x6' - 6" thick Precast Vault for Sump Pump in Pit	1.00 ea	1,202	1,345	-	499	-	3,045.89 /ea	3,046	2,590	5,635.85 /ea
			Frame & Grate - Single	3.00 ea	691	1,098	-	-	-	596.24 /ea	1,789	1,520	1,102.96 /ea
			Vertical Sump Pump 250 gpm - 2hp	1.00 ea	1,554	250	-	-	5,500	7,303.63 /ea	7,304	6,261	13,564.42 /ea
			PC Vaults Precast Concrete Vaults	2.00 ea	5,850	5,383		1,497	5,500	9,115.02 /ea	18,230	15,551	16,890.41 /ea
			4 Yard Piping, Mech Piping, Fittings & Valves	1.00 ls	99,131	160,332	9,595	8,073	5,500	282,630.73 /ls	282,631	241,546	524,177.04 /ls
	5		Furnish & Install Pumps										
		VT Pumps	Vertical Turbine Pumps										
			Equipment Pad Form > 8"	64.00 sf	963	101	-	-	-	16.63 /sf	1,064	881	30.39 /sf
			Set Anchor Bolts 2/Set	8.00 ea	828	264	-	-	-	136.54 /ea	1,092	911	250.41 /ea
			Chamfer	32.00 lf	19	21	-	-	-	1.26 /lf	40	34	2.33 /lf
			Strip & Oil Equipment Pad Form	64.00 sf	13	3	-	-	-	0.24 /sf	15	13	0.44 /sf
			Misc. Pad Rebar	0.42 tn	378	427	-	-	-	1,941.10 /tn	806	682	3,583.88 /tn
			Finish- Float	32.00 sf	22	-	-	-	-	0.68 /sf	22	18	1.23 /sf
			Buggy Place Equipment Pads	2.37 cy	488	-	-	-	-	205.87 /cy	488	402	375.46 /cy
			4500 psi Concrete	2.37 cy	-	419	-	-	-	176.91 /cy	419	363	330.16 /cy
			Liquid Curing Compounds	32.00 sf	4	22	-	-	-	0.80 /sf	26	22	1.49 /sf
			Vertical Turbine Well Pumpand 350hp Motor - upgrade	1.00 ea	9,609	2,500	-	1,996	265,000	279,105.57 /ea	279,106	241,379	520,484.93 /ea
			Vertical Turbine Booster Pump and 400 hp Motor - refurbish	1.00 ea	12,012	2,500	-	1,996	8,000	24,507.91 /ea	24,508	20,730	45,237.60 /ea
			VT Pumps Vertical Turbine Pumps	2.00 ea	24,336	6,257		3,992	273,000	153,792.87 /ea	307,586	265,435	286,510.21 /ea
			5 Furnish & Install Pumps	1.00 ls	24,336	6,257		3,992	273,000	307,585.74 /ls	307,586	265,435	573,020.41 /ls
	6		IX Vessels and Appurtenances										
		IX Vesels & Appurtenances	IX Vessels and Appurtenances										

Opinion of Probable Construction Cost
30% Design

WBS Lvl 1	WBS Lvl 2	WBS Lvl 3	Description	Takeoff Quantity	Labor Amount	Material Amount	Sub Amount	Equip Amount	Other Amount	Total Cost/Unit	Total Amount	Addon Amount	Grand Total Price
		IX Vesels & Appurtenances	IX Vessels and Appurtenances										
			Backflow Preventer Fig 12" CS Goose Neck	1.00 ea	797	12,755	-	-	-	13,551.91 /ea	13,552	11,706	25,257.50 /ea
			Gasket/Nuts/Bolt Kit 12"	16.00 ea	741	720	-	-	-	91.34 /ea	1,461	1,234	168.49 /ea
			Stainless Nuts & Bolts 12" Gr. B8	16.00 ea	641	3,050	-	-	-	230.65 /ea	3,690	3,170	428.75 /ea
			IB BFV Handwheel FL 150# 12" - influent line	2.00 ea	666	3,200	-	-	-	1,932.98 /ea	3,866	3,321	3,593.29 /ea
			IB BFV Handwheel FL 150# 12" - backwash supply	2.00 ea	666	3,200	-	-	-	1,932.98 /ea	3,866	3,321	3,593.28 /ea
			IB BFV Handwheel FL 150# 12" - to waste	1.00 ea	333	1,600	-	-	-	1,932.98 /ea	1,933	1,660	3,593.29 /ea
			IX Vessels 12ft diam - 424 ft3 - Install w/ appurtenances (FBO)	4.00 ea	30,750	4,800	-	15,970	-	12,879.90 /ea	51,520	42,480	23,499.86 /ea
			Bag Filters - Furnish & Install	2.00 ea	7,687	2,400	-	3,992	37,700	25,889.96 /ea	51,780	44,317	48,048.68 /ea
			IX Vesels & Appurtenances IX Vessels and Appurtenances	1.00 ls	42,281	31,725		19,962	37,700	131,668.08 /ls	131,668	111,208	242,876.51 /ls
			6 IX Vessels and Appurtenances	1.00 ls	42,281	31,725		19,962	37,700	131,668.08 /ls	131,668	111,208	242,876.51 /ls
	7		Furnish and Install Electrical / Controls and Instrumentation										
		sub	Subcontractor Pricing - see detailed EIC estimate										
			7A - New SS Starter and Breaker in MCC (based on Eaton)	1.00 ls	-	-	35,466	-	-	35,466.00 /ls	35,466	34,003	69,469.34 /ls
			7B - New Electrical Conduit for 350 hp pump	1.00 ls	-	-	58,412	-	-	58,412.00 /ls	58,412	56,003	114,415.04 /ls
			7C - Lights and Recepticles - Vessels Pit	1.00 ls	-	-	79,044	-	-	79,044.00 /ls	79,044	75,784	154,828.17 /ls
			7D - Lights and Recepticles - Filters	1.00 ls	-	-	45,221	-	-	45,221.00 /ls	45,221	43,356	88,577.05 /ls
			7E - General Electrical work	1.00 ls	-	-	74,994	-	-	74,994.00 /ls	74,994	71,901	146,895.20 /ls
			7F - Trenching for Electrical	1.00 ls	-	-	11,681	-	-	11,681.00 /ls	11,681	11,199	22,880.26 /ls
			7G - Elec Start-up and Testing	1.00 ls	-	-	10,694	-	-	10,694.00 /ls	10,694	10,253	20,946.96 /ls
			sub Subcontractor Pricing - see detailed EIC estimate	1.00 ls			315,512			315,512.00 /ls	315,512	302,500	618,012.02 /ls
			7 Furnish and Install Electrical / Controls and Instrumentation	1.00 ls			315,512			315,512.00 /ls	315,512	302,500	618,012.02 /ls
	8		Start-up Testing and Training										
		* unassigned *											
			Equipment Start-Up - each	8.00 ea	2,757	472	-	-	-	403.61 /ea	3,229	2,597	728.25 /ea
			Manufacturer's Rep Time	10.00 day	-	-	0	-	12,000	1,200.00 /day	12,000	10,395	2,239.51 /day
			Pre-Operation Testing & Start-up (IX Filters, Bag Filters & VT Pumps)	3.00 day	8,551	750	-	-	-	3,100.46 /day	9,301	7,437	5,579.61 /day
			Functional Testing - support	3.00 day	8,551	750	-	-	-	3,100.46 /day	9,301	7,437	5,579.59 /day
			Operational Testing - support	3.00 day	8,551	1,500	-	-	-	3,350.46 /day	10,051	8,087	6,046.16 /day
			Acceptance Testing - support	3.00 day	8,551	1,500	-	-	-	3,350.46 /day	10,051	8,087	6,046.16 /day
			* unassigned *		36,962	4,972			12,000		53,934	44,041	
			8 Start-up Testing and Training	1.00 ls	36,962	4,972			12,000	53,934.34 /ls	53,934	44,041	97,975.70 /ls
	9		Prepare Operationa and Maintenance Manuals										
		* unassigned *											
			O&M Manuals - Furnished by vendors	1.00 ls	2,000	1,000	-	-	-	3,000.00 /ls	3,000	2,454	5,453.79 /ls
			* unassigned *		2,000	1,000					3,000	2,454	
			9 Prepare Operationa and Maintenance Manuals	1.00 ls	2,000	1,000				3,000.00 /ls	3,000	2,454	5,453.79 /ls
	10		Maintain and Prepare Record Drawings										
		* unassigned *											
			As Built Drawings & Records	1.00 ls	1,200	1,000	-	-	-	2,200.00 /ls	2,200	1,819	4,018.76 /ls
			* unassigned *		1,200	1,000					2,200	1,819	
			10 Maintain and Prepare Record Drawings	1.00 ls	1,200	1,000				2,200.00 /ls	2,200	1,819	4,018.76 /ls
	11		Furnish & Install Erosion Control Measures										
		* unassigned *											
			Erosion Control-LS - Allow	1.00 allow	-	-	5,000	-	-	5,000.00 /allow	5,000	4,794	9,793.80 /allow
			* unassigned *				5,000				5,000	4,794	
			11 Furnish & Install Erosion Control Measures	1.00 ls			5,000			5,000.00 /ls	5,000	4,794	9,793.80 /ls
	12		Furnish and Install Excavation Safety Measures										
		* unassigned *											
			Structure Sheeting 10'deep	2,120.00 sf	6,244	42,400	-	1,959	-	23.87 /sf	50,603	43,579	44.43 /sf
			Excavation Support & Protection - engineering & design	1.00 ls	-	3,500	-	-	-	3,500.00 /ls	3,500	3,032	6,531.90 /ls
			* unassigned *		6,244	45,900		1,959			54,103	46,611	
			12 Furnish and Install Excavation Safety Measures	1.00 ls	6,244	45,900		1,959		54,102.57 /ls	54,103	46,611	100,713.84 /ls
			Alt 6 Alternative 6	1.00 ls	266,440	325,218	390,148	48,832	328,200	1,358,838.51 /ls	1,358,839	1,267,700	2,626,538.05 /ls

Opinion of Probable Construction Cost
30% Design

Estimate Totals

Description	Amount	Totals	Hours	Rate	Cost Basis	Cost per Unit	Percent of Total
Labor	266,440		5,733 hrs			133.220 /gpm	10.14%
Material	325,218					162.609 /gpm	12.38%
Subcontract	390,148					195.074 /gpm	14.85%
Equipment	48,832		1,230 hrs			24.416 /gpm	1.86%
Process Equip	328,200					164.100 /gpm	12.50%
Patrial Direct Subtotal	1,358,838	1,358,838				679.419 /gpm	51.73% #####
Mob/Demob	67,942			5.00 %	T	33.971 /gpm	2.59%
Sales Tax	54,424			7.75 %	C	27.212 /gpm	2.07%
Small Tools & Equipment	2,818			1.50 %	C	1.409 /gpm	0.11%
Safety Supplies & Equipment	1,576			0.50 %	C	0.788 /gpm	0.06%
Consumables	2,818			1.50 %	C	1.409 /gpm	0.11%
Mob/Demob, Misc. Subtotal	129,578	1,488,416				744.208 /gpm	4.93% #####
Subcontractor OH&P (mid)	58,522			15.00 %	C	29.261 /gpm	2.23%
Bond on Subcontractors	7,803			2.00 %	C	3.901 /gpm	0.30%
Subcontractor Mark-Ups	66,325	1,554,741				777.371 /gpm	2.53% #####
Escalation	49,752			3.20 %	T	24.876 /gpm	1.89%
Escalation Subtotal	49,752	1,604,493				802.247 /gpm	1.89% #####
General Conditions (mid)	160,449			10.00 %	T	80.225 /gpm	6.11%
General Conditions Subtotal	160,449	1,764,942				882.471 /gpm	6.11% #####
Contingency (%)	441,236			25.00 %	T	220.618 /gpm	16.80%
Contingency Subtotal	441,236	2,206,178				1,103.089 /gpm	16.80% #####
Overhead & Profit	330,927			15.00 %	T	165.463 /gpm	12.60%
GC OH&P Subtotal	330,927	2,537,105				1,268.553 /gpm	12.60% #####
Permits	25,371			1.00 %	T	12.686 /gpm	0.97%
Builder's Risk Insurance	38,057			1.50 %	T	19.028 /gpm	1.45%
Performance & Payment Bond (%)	26,005			1.00 %	T	13.003 /gpm	0.99%
Permits, Bonds & Insurance	89,433	2,626,538				1,313.269 /gpm	3.40% #####
Total Construction Costs (TCC)	2,626,538	2,626,538				1,313.269 /gpm	#####
Total		2,626,538				1,313.269 /gpm	

IRWD OPA-1 E&I Estimate

Description	Quantity	UoM	Labor Prod - Base	Labor Hours	Labor Rate	Labor Total	Mat Unit Price	Materials Total	Subs Unit Price	Subs Total	Total Direct Cost
7A - E&I - New Solid State Starter & Breaker	1	LS		25	\$75.13	1,878	50,000	50,000	1,000	1,000	52,503
26.00 - Electrical	1	LS		25	\$75.13	1,878	50,000	50,000	1,000	1,000	52,503
Electrical		Inft		25	\$75.13	1,878	50,000.00	50,000.00	1,000.00	1,000.00	52,503.00
Install 480V Size 6 Solid State Motor Starter in Existing MCC Cabinet	1	each	20	20	\$75.13	1,503	50,000	50,000	1,000.00	1,000	52,503
480V Size 6 Solid State Motor Starter - Modifications to Existing Cabinet	1	each	8	8	\$75.13	601	1,500	1,500			2,101
480V Size 6 Solid State Motor Starter - Vendor Support	1	each			\$75.13				1,000.00	1,000	1,000
Install 480V Size 6 Solid State Motor Starter in Existing MCC Cabinet	1	each	12	12	\$75.13	902	19,952	19,952			20,854
Lockout/Tagout - for installation of Size 6 Motor Starter 350HP VT Well Pump	1	each	5	5	\$75.13	376					376
Lockout/Tagout - for installation of Size 6 Motor Starter 350HP VT Well Pump	1	each	5	5	\$75.13	376					376
7B - E&I - New Electrical Conduit/Cable for 350HP Pump	1	LS		202.883	\$75.13	15,243		23,243.89			38,486
26.00 - Electrical	1	LS		202.883	\$75.13	15,243		23,243.89			38,486
Electrical	662	Inft	0.3065	202.883	\$75.13	15,243	35.1116	23,243.89			38,486
350HP VT Well Pump - 3" RGS Conduit (2 Runs)	150	Inft	0.7271	109.068	\$75.13	8,194	43.1799	6,476.98			14,671
3" RGS Conduit	150	Inft	0.2	30	\$75.13	2,254	12.63	1,894.50			4,148
3" RGS Conduit Seal Fitting "EYS"	4	each	1.4	5.6	\$75.13	421	128.3865	513.5461			934
3" RGS ELL	6	each	2	12	\$75.13	902	34.2529	205.5175			1,107
3" RGS LB	4	each	3.5	14	\$75.13	1,052	211.1813	844.7252			1,897
3" RGS TEE	4	each	4.5	18	\$75.13	1,352	237.1131	948.4523			2,301
3" RGS Union	4	each	1.75	7	\$75.13	526	118.5678	474.2712			1,000
3" RGS Meyers Hub	4	each	1.95	7.8	\$75.13	586	24.8959	99.5834			686
3" Conduit Support - RGS	20	each	0.6	12	\$75.13	902	4.8193	96.3856			998
3" Conduit Penetration	4	each	0.667	2.668	\$75.13	200	350	1,400			1,600
350HP VT Well Pump - 3/C - 350 MCM (185 mm2) w/ Grd - CU XHHW-2 (2 Runs)	610	Inft	0.1417	93.815	\$75.13	7,048	25.3277	16,766.91			23,815
3/C - 350 MCM (185 mm2) w/ Grd - CU XHHW-2	610	Inft	0.0825	50.325	\$75.13	3,781	24.794	15,124.34			18,905
3/C - 350 MCM (185 mm2) w/ Grd - CU XHHW-2	52	Inft	0.0825	4.29	\$75.13	322	24.794	1,289.29			1,612
1/C - 350 MCM (185 mm2) - 600V Terms - incl'd lugs, tape, labels, phoning out & testing	16	each	2.45	39.2	\$75.13	2,945	22.08	353.28			3,298
7C - E&I - Lights & Receptacles - Vessels Pit	1	LS		401.4595	\$75.13	30,162		20,984.16			51,146
26.00 - Electrical	1	LS		401.4595	\$75.13	30,162		20,984.16			51,146
Electrical	1,155	Inft	0.3476	401.4595	\$75.13	30,162	18.1681	20,984.16			51,146
120/208V 3Ph 100A Panel Board 24 Circuit	1	each	11	11	\$75.13	826	920	920			1,746
120/208V 3Ph 100A Panel Board 24 Circuit	1	each	8	8	\$75.13	601	795	795			1,396
120/208V 3Ph 100A Panel Board 12 Circuit - Support	1	each	3	3	\$75.13	225	125	125			350
120V Convenience Receptacle w/ Box & WP Cover	4	each	3.5	14	\$75.13	1,052	150	600			1,652
120V Convenience Receptacle w/ Box & WP Cover	4	each	3.5	14	\$75.13	1,052	150	600			1,652
120V Single Pole Light Switch w/ Box & WP Cover	2	each	2.5	5	\$75.13	376	135	270			646
120V Single Pole Light Switch w/ Box & WP Cover	2	each	2.5	5	\$75.13	376	135	270			646
480/208-120V 3Phase Transformer 15kva	1	each	15.5	15.5	\$75.13	1,165	2,093	2,093			3,258
480/208-120V 3Phase Transformer 15kva	1	each	12	12	\$75.13	902	1,943	1,943			2,845
480/208-120V 3Phase Transformer 15kva - Support	1	each	3.5	3.5	\$75.13	263	150	150			413
LED 120V Exit Light w/ Battery Pack	2	each	1.5	3	\$75.13	225	252.5	505			730
LED 120V Exit Light w/ Battery Pack	2	each	1.5	3	\$75.13	225	252.5	505			730
LED Emergency Light w/ 2 lamps & Battery Pack incl'd Support	3	each	4	12	\$75.13	902	1,083.43	3,250.29			4,152
LED Emergency Light w/ 2 lamps & Battery Pack incl'd Support	3	each	4	12	\$75.13	902	1,083.43	3,250.29			4,152
LED Fixture incl'd Support	10	each	3.33	33.3	\$75.13	2,502	762.92	7,629.20			10,131
LED Fixture incl'd Support	10	each	3.33	33.3	\$75.13	2,502	762.92	7,629.20			10,131
Lighting & Receptacles - 3/4" RGS Conduit (21 Runs)	525	Inft	0.3338	175.248	\$75.13	13,166	7.015	3,682.87			16,849
3/4" RGS Conduit	525	Inft	0.06	31.5	\$75.13	2,367	1.77	929.25			3,296
3/4" RGS Conduit Seal Fitting "EYS"	21	each	0.6	12.6	\$75.13	947	19.5924	411.4404			1,358
3/4" RGS ELL	42	each	0.4	16.8	\$75.13	1,262	4.0423	169.7783			1,432
3/4" RGS LB	21	each	0.65	13.65	\$75.13	1,026	20.2793	425.8645			1,451
3/4" RGS TEE	21	each	1	21	\$75.13	1,578	23.646	496.566			2,074
3/4" RGS Union	21	each	0.7	14.7	\$75.13	1,104	12.341	259.1602			1,364
3/4" RGS Meyers Hub	21	each	0.75	15.75	\$75.13	1,183	4.1775	87.7267			1,271
3/4" Conduit Support - RGS	105	each	0.45	47.25	\$75.13	3,550	1.8579	195.0795			3,745
3/4" Conduit Penetration	6	each	0.333	1.998	\$75.13	150	118	708			858
Lighting & Receptacles - 3/C - 12 AWG (4 mm2) w/ Grd - CU THHN-THWN (21 Runs)	735	Inft	0.0991	97.8075	\$75.13	7,348	0.9429	930.6727			8,279
3/C - 12 AWG (4 mm2) w/ Grd - CU THHN-THWN	735	Inft	0.0225	16.5375	\$75.13	1,242	0.6382	469.1137			1,712
3/C - 12 AWG (4 mm2) w/ Grd - CU THHN-THWN	252	Inft	0.0225	5.67	\$75.13	426	0.6382	160.839			587
1/C - 12 AWG (4 mm2) - 600V Terms - incl'd lugs, tape, labels, phoning out & testing	168	each	0.45	75.6	\$75.13	5,680	1.79	300.72			5,981

IRWD OPA-1 E&I Estimate

Description	Quantity	UoM	Labor Prod - Base	Labor Hours	Labor Rate	Labor Total	Mat Unit Price	Materials Total	Subs Unit Price	Subs Total	Total Direct Cost
Lighting Xfmr & Panel - 1" RGS Conduit	100	lnft	0.2266	22.664	\$75.13	1,703	6.2965	629.6484			2,332
1" RGS Conduit	100	lnft	0.07	7	\$75.13	526	2.81	281			807
1" RGS Conduit Seal Fitting "EYS"	1	each	0.7	0.7	\$75.13	53	25.1661	25.1661			78
1" RGS ELL	3	each	0.5	1.5	\$75.13	113	5.3935	16.1806			129
1" RGS LB	2	each	0.8	1.6	\$75.13	120	29.5462	59.0925			179
1" RGS TEE	1	each	1.25	1.25	\$75.13	94	34.7033	34.7033			129
1" RGS Union	1	each	0.8	0.8	\$75.13	60	21.0112	21.0112			81
1" RGS Meyers Hub	2	each	0.9	1.8	\$75.13	135	4.9882	9.9764			145
1" Conduit Support - RGS	17	each	0.45	7.65	\$75.13	575	2.207	37.5183			612
1" Conduit Penetration	1	each	0.364	0.364	\$75.13	27	145	145			172
Lighting Xfmr & Panel - 3/C - 6 AWG (16 mm2) w/ Grd - CU XHHW-2	150	lnft	0.0711	11.94	\$75.13	897	2.8184	473.484			1,371
3/C - 6 AWG (16 mm2) w/ Grd - CU XHHW-2	150	lnft	0.0225	3.375	\$75.13	254	2.4955	374.325			628
3/C - 6 AWG (16 mm2) w/ Grd - CU XHHW-2	18	lnft	0.0225	0.405	\$75.13	30	2.4955	44.919			75
1/C - 6 AWG (16 mm2) - 600V Terms - incl'd lugs, tape, labels, phoning out & testing	8	each	1.02	8.16	\$75.13	613	6.78	54.24			667
7D - E&I - Lights & Receptacles - Filters	1	LS		234.5655	\$75.13	17,623		11,601.34			29,224
26.00 - Electrical	1	LS		234.5655	\$75.13	17,623		11,601.34			29,224
Electrical	685	lnft	0.3424	234.5655	\$75.13	17,623	16.9363	11,601.34			29,224
120/208V 3Ph 100A Panel Board 12 Circuit	1	each	9	9	\$75.13	676	625	625			1,301
120/208V 3Ph 100A Panel Board 12 Circuit	1	each	6	6	\$75.13	451	525	525			976
120/208V 3Ph 100A Panel Board 12 Circuit - Support	1	each	3	3	\$75.13	225	100	100			325
120V Convenience Receptacle w/ Box & WP Cover	2	each	3.5	7	\$75.13	526	150	300			826
120V Convenience Receptacle w/ Box & WP Cover	2	each	3.5	7	\$75.13	526	150	300			826
120V Single Pole Light Switch w/ Box & WP Cover	1	each	2.5	2.5	\$75.13	188	135	135			323
120V Single Pole Light Switch w/ Box & WP Cover	1	each	2.5	2.5	\$75.13	188	135	135			323
480/208-120V 3Phase Transformer 5kva	1	each	13	13	\$75.13	977	1,125	1,125			2,102
480/208-120V 3Phase Transformer 5kva	1	each	10	10	\$75.13	751	975	975			1,726
480/208-120V 3Phase Transformer 5kva - Support	1	each	3	3	\$75.13	225	150	150			375
LED 120V Exit Light w/ Battery Pack	1	each	1.5	1.5	\$75.13	113	252.5	252.5			365
LED 120V Exit Light w/ Battery Pack	1	each	1.5	1.5	\$75.13	113	252.5	252.5			365
LED Emergency Light w/ 2 lamps & Battery Pack incl'd Support	1	each	4	4	\$75.13	301	1,083.43	1,083.43			1,384
LED Emergency Light w/ 2 lamps & Battery Pack incl'd Support	1	each	4	4	\$75.13	301	1,083.43	1,083.43			1,384
LED Fixture incl'd Support	6	each	3.33	19.98	\$75.13	1,501	762.92	4,577.52			6,079
LED Fixture incl'd Support	6	each	3.33	19.98	\$75.13	1,501	762.92	4,577.52			6,079
Lighting & Receptacles - 3/4" RGS Conduit (11 Runs)	275	lnft	0.3336	91.749	\$75.13	6,893	6.9537	1,912.26			8,805
3/4" RGS Conduit	275	lnft	0.06	16.5	\$75.13	1,240	1.77	486.75			1,726
3/4" RGS Conduit Seal Fitting "EYS"	11	each	0.6	6.6	\$75.13	496	19.5924	215.5164			711
3/4" RGS ELL	22	each	0.4	8.8	\$75.13	661	4.0423	88.9315			750
3/4" RGS LB	11	each	0.65	7.15	\$75.13	537	20.2793	223.0719			760
3/4" RGS TEE	11	each	1	11	\$75.13	826	23.646	260.106			1,087
3/4" RGS Union	11	each	0.7	7.7	\$75.13	579	12.341	135.7506			714
3/4" RGS Meyers Hub	11	each	0.75	8.25	\$75.13	620	4.1775	45.9521			666
3/4" Conduit Support - RGS	55	each	0.45	24.75	\$75.13	1,859	1.8579	102.1845			1,962
3/4" Conduit Penetration	3	each	0.333	0.999	\$75.13	75	118	354			429
Lighting & Receptacles - 3/C - 12 AWG (4 mm2) w/ Grd - CU THHN-THWN (11 Runs)	385	lnft	0.0991	51.2325	\$75.13	3,849	0.9429	487.4952			4,337
3/C - 12 AWG (4 mm2) w/ Grd - CU THHN-THWN	385	lnft	0.0225	8.6625	\$75.13	651	0.6382	245.7262			897
3/C - 12 AWG (4 mm2) w/ Grd - CU THHN-THWN	132	lnft	0.0225	2.97	\$75.13	223	0.6382	84.249			307
1/C - 12 AWG (4 mm2) - 600V Terms - incl'd lugs, tape, labels, phoning out & testing	88	each	0.45	39.6	\$75.13	2,975	1.79	157.52			3,133
Lighting Xfmr & Panel - 1" RGS Conduit	100	lnft	0.2266	22.664	\$75.13	1,703	6.2965	629.6484			2,332
1" RGS Conduit	100	lnft	0.07	7	\$75.13	526	2.81	281			807
1" RGS Conduit Seal Fitting "EYS"	1	each	0.7	0.7	\$75.13	53	25.1661	25.1661			78
1" RGS ELL	3	each	0.5	1.5	\$75.13	113	5.3935	16.1806			129
1" RGS LB	2	each	0.8	1.6	\$75.13	120	29.5462	59.0925			179
1" RGS TEE	1	each	1.25	1.25	\$75.13	94	34.7033	34.7033			129
1" RGS Union	1	each	0.8	0.8	\$75.13	60	21.0112	21.0112			81
1" RGS Meyers Hub	2	each	0.9	1.8	\$75.13	135	4.9882	9.9764			145
1" Conduit Support - RGS	17	each	0.45	7.65	\$75.13	575	2.207	37.5183			612
1" Conduit Penetration	1	each	0.364	0.364	\$75.13	27	145	145			172
Lighting Xfmr & Panel - 3/C - 6 AWG (16 mm2) w/ Grd - CU XHHW-2	150	lnft	0.0711	11.94	\$75.13	897	2.8184	473.484			1,371
3/C - 6 AWG (16 mm2) w/ Grd - CU XHHW-2	150	lnft	0.0225	3.375	\$75.13	254	2.4955	374.325			628
3/C - 6 AWG (16 mm2) w/ Grd - CU XHHW-2	18	lnft	0.0225	0.405	\$75.13	30	2.4955	44.919			75

IRWD OPA-1 E&I Estimate

Description	Quantity	UoM	Labor Prod - Base	Labor Hours	Labor Rate	Labor Total	Mat Unit Price	Materials Total	Subs Unit Price	Subs Total	Total Direct Cost
1/C - 6 AWG (16 mm2) - 600V Terms - incl'd lugs, tape, labels, phoning out & testing	8	each	1.02	8.16	\$75.13	613	6.78	54.24			667
7E - E&I - General Electrical	1	LS		503.106	\$75.13	37,798		9,827.12			47,625
13.00 - Instrumentation	1	LS		169.2	\$75.13	12,712		2,220			14,932
Electrical		Inft		16	\$75.13	1,202		600			1,802
Bag Filter Control Panel - furn'd by Vendor	2	each	4	8	\$75.13	601	150	300			901
Bag Filter Control Panel - Support	2	each	4	8	\$75.13	601	150	300			901
IX Control Panel - furn'd by Vendor	2	each	4	8	\$75.13	601	150	300			901
IX Control Panel - Support	2	each	4	8	\$75.13	601	150	300			901
Instrumentation		each		153.2	\$75.13	11,510		1,620			13,130
Bag Filter - DPT - Diff Pressure Transmitter - furn'd by Vendor	4	each	19.9	79.6	\$75.13	5,980	305	1,220			7,200
DPT - Diff Pressure Transmitter - furn'd by Vendor	4	each	4.9	19.6	\$75.13	1,473					1,473
Misc Installation Bulks	4	each	3	12	\$75.13	902	150	600			1,502
Manifold, 2-VALVE - furn'd by Vendor	4	each	1.5	6	\$75.13	451					451
Instrument Support	4	each	5	20	\$75.13	1,503	155	620			2,123
Calibration - Transmitters (field verification of factory settings)	4	each	2.5	10	\$75.13	751					751
Loop Check (Standard)	4	each	3	12	\$75.13	902					902
Bag Filter - PI - Pressure Indicator - furn'd by Vendor	8	each	5.2	41.6	\$75.13	3,125	50	400			3,525
PI - Pressure Indicator - furn'd by Vendor	8	each	2.1	16.8	\$75.13	1,262					1,262
Misc Installation Bulks	8	each	1.5	12	\$75.13	902	50	400			1,302
Calibration - Indicators & Gauges (field verification of factory settings)	8	each	1.6	12.8	\$75.13	962					962
Bag Filter Control Panel - furn'd by Vendor	2	each	8	16	\$75.13	1,202					1,202
Bag Filter Control Panel - furn'd by Vendor	2	each	8	16	\$75.13	1,202					1,202
IX Control Panel - furn'd by Vendor	2	each	8	16	\$75.13	1,202					1,202
IX Control Panel - furn'd by Vendor	2	each	8	16	\$75.13	1,202					1,202
26.00 - Electrical	1	LS		333.906	\$75.13	25,086		7,607.12			32,693
Electrical	1,068	Inft	0.3126	333.906	\$75.13	25,086	7.1228	7,607.12			32,693
Bag Filter Control Panel - 1" RGS Conduit (2 Runs)	250	Inft	0.2421	60.528	\$75.13	4,547	6.5964	1,649.09			6,197
1" RGS Conduit	250	Inft	0.07	17.5	\$75.13	1,315	2.81	702.5			2,017
1" RGS Conduit Seal Fitting "EYS"	4	each	0.7	2.8	\$75.13	210	25.1661	100.6644			311
1" RGS ELL	8	each	0.5	4	\$75.13	301	5.3935	43.1483			344
1" RGS LB	6	each	0.8	4.8	\$75.13	361	29.5462	177.2774			538
1" RGS TEE	4	each	1.25	5	\$75.13	376	34.7033	138.8133			514
1" RGS Union	4	each	0.8	3.2	\$75.13	240	21.0112	84.0446			324
1" RGS Meyers Hub	4	each	0.9	3.6	\$75.13	270	4.9882	19.9527			290
1" Conduit Support - RGS	42	each	0.45	18.9	\$75.13	1,420	2.207	92.6923			1,513
1" Conduit Penetration	2	each	0.364	0.728	\$75.13	55	145	290			345
Bag Filter Control Panel - 7/C - 14 AWG (2.5 mm2) - CU XHHW-2 - Control Cable (2 Runs)	400	Inft	0.0448	19.7	\$75.13	1,480	1.3214	581.42			2,061
7/C - 14 AWG (2.5 mm2) - CU XHHW-2 - Control Cable	400	Inft	0.0225	9	\$75.13	676	1.2075	483			1,159
7/C - 14 AWG (2.5 mm2) - CU XHHW-2 - Control Cable	40	Inft	0.0225	0.9	\$75.13	68	1.2075	48.3			116
1/C - 14 AWG (2.5 mm2) - 600V Terms - incl'd lugs, tape, labels, phoning out & testing	28	each	0.35	9.8	\$75.13	736	1.79	50.12			786
Bag Filter DPT to Cntl Panel - 1 PR - 16 AWG (1.5 mm2) Twisted Shielded XLPE/PVC CU (4 Runs)	140	Inft	0.0533	10.02	\$75.13	753	0.4116	77.38			830
1 PR - 16 AWG (1.5 mm2) Twisted Shielded XLPE/PVC CU	140	Inft	0.015	2.1	\$75.13	158	0.275	38.5			196
1 PR - 16 AWG (1.5 mm2) Twisted Shielded XLPE/PVC CU	48	Inft	0.015	0.72	\$75.13	54	0.275	13.2			67
16 AWG (1.5 mm2) - TERMS - incl'd lugs, labels & phoning out	24	each	0.3	7.2	\$75.13	541	1.07	25.68			567
Bag Filter DPT to Cntl Panel - 3/4" RGS Conduit (4 Runs)	100	Inft	0.33	33	\$75.13	2,479	5.6664	566.641			3,046
3/4" RGS Conduit	100	Inft	0.06	6	\$75.13	451	1.77	177			628
3/4" RGS Conduit Seal Fitting "EYS"	4	each	0.6	2.4	\$75.13	180	19.5924	78.3696			259
3/4" RGS ELL	8	each	0.4	3.2	\$75.13	240	4.0423	32.3387			273
3/4" RGS LB	4	each	0.65	2.6	\$75.13	195	20.2793	81.117			276
3/4" RGS TEE	4	each	1	4	\$75.13	301	23.646	94.584			395
3/4" RGS Union	4	each	0.7	2.8	\$75.13	210	12.341	49.3638			260
3/4" RGS Meyers Hub	4	each	0.75	3	\$75.13	225	4.1775	16.7098			242
3/4" Conduit Support - RGS	20	each	0.45	9	\$75.13	676	1.8579	37.158			713
Filter Area - Grounding w/ Details incl'd Grnd Rods	160	Inft	0.2719	43.51	\$75.13	3,269	5.4466	871.46			4,140
Copperclad Ground Rod 3/4" X 10'	3	each	2	6	\$75.13	451	24.15	72.45			523
1/C - #4/0 AWG (120 mm2) Bare Ground Wire CU - Below Grade	60	Inft	0.052	3.12	\$75.13	234	3.5	210			444
1/C - 2 AWG (35 mm2) Green Insulated Wire CU - A/G	100	Inft	0.045	4.5	\$75.13	338	1.18	118			456
U/G Main Grid Cadweld - #1/0 & Smaller	4	each	1.38	5.52	\$75.13	415	12.75	51			466
U/G Main Grid Cadweld - #2/0 & Larger	2	each	1.56	3.12	\$75.13	234	22.5	45			279
Building & Steel Ground Mechanical Connection	2	each	1.5	3	\$75.13	225	42.75	85.5			311

IRWD OPA-1 E&I Estimate

Description	Quantity	UoM	Labor Prod - Base	Labor Hours	Labor Rate	Labor Total	Mat Unit Price	Materials Total	Subs Unit Price	Subs Total	Total Direct Cost
Equipment Mechanical Ground Connection	2	each	1.5	3	\$75.13	225	37.5	75			300
PVC Stub-ups (w/ PVC Conduit & Anchor/Straps)	4	each	1.5	6	\$75.13	451	15	60			511
Ground Well & Cover	1	each	3.25	3.25	\$75.13	244	154.51	154.51			399
Electrical Trenching / Backfill for Underground Ground Cable	60	lnft	0.1	6	\$75.13	451					451
IX Control Panel - 1" RGS Conduit (2 Runs)	250	lnft	0.2421	60.528	\$75.13	4,547	6.5964	1,649.09			6,197
1" RGS Conduit	250	lnft	0.07	17.5	\$75.13	1,315	2.81	702.5			2,017
1" RGS Conduit Seal Fitting "EYS"	4	each	0.7	2.8	\$75.13	210	25.1661	100.6644			311
1" RGS ELL	8	each	0.5	4	\$75.13	301	5.3935	43.1483			344
1" RGS LB	6	each	0.8	4.8	\$75.13	361	29.5462	177.2774			538
1" RGS TEE	4	each	1.25	5	\$75.13	376	34.7033	138.8133			514
1" RGS Union	4	each	0.8	3.2	\$75.13	240	21.0112	84.0446			324
1" RGS Meyers Hub	4	each	0.9	3.6	\$75.13	270	4.9882	19.9527			290
1" Conduit Support - RGS	42	each	0.45	18.9	\$75.13	1,420	2.207	92.6923			1,513
1" Conduit Penetration	2	each	0.364	0.728	\$75.13	55	145	290			345
IX Control Panel - 7/C - 14 AWG (2.5 mm2) - CU XHHW-2 - Control Cable (2 Runs)	400	lnft	0.0448	19.7	\$75.13	1,480	1.3214	581.42			2,061
7/C - 14 AWG (2.5 mm2) - CU XHHW-2 - Control Cable	400	lnft	0.0225	9	\$75.13	676	1.2075	483			1,159
7/C - 14 AWG (2.5 mm2) - CU XHHW-2 - Control Cable	40	lnft	0.0225	0.9	\$75.13	68	1.2075	48.3			116
1/C - 14 AWG (2.5 mm2) - 600V Terms - incl'd lugs, tape, labels, phoning out & testing	28	each	0.35	9.8	\$75.13	736	1.79	50.12			786
Lockout/Tagout - for Refurbish 400HP VT Booster Pump	1	each	6	6	\$75.13	451					451
Lockout/Tagout - for Refurbish 400HP VT Booster Pump	1	each	6	6	\$75.13	451					451
Vessel Area - Grounding w/ Details incl'd Gnd Rods	350	lnft	0.2312	80.92	\$75.13	6,080	4.6589	1,630.61			7,710
Copperclad Ground Rod 3/4" X 10"	4	each	2	8	\$75.13	601	24.15	96.6			698
1/C - #4/0 AWG (120 mm2) Bare Ground Wire CU - Below Grade	200	lnft	0.052	10.4	\$75.13	781	3.5	700			1,481
1/C - 2 AWG (35 mm2) Green Insulated Wire CU - A/G	150	lnft	0.045	6.75	\$75.13	507	1.18	177			684
U/G Main Grid Cadweld - #1/0 & Smaller	6	each	1.38	8.28	\$75.13	622	12.75	76.5			699
U/G Main Grid Cadweld - #2/0 & Larger	4	each	1.56	6.24	\$75.13	469	22.5	90			559
Building & Steel Ground Mechanical Connection	4	each	1.5	6	\$75.13	451	42.75	171			622
Equipment Mechanical Ground Connection	2	each	1.5	3	\$75.13	225	37.5	75			300
PVC Stub-ups (w/ PVC Conduit & Anchor/Straps)	6	each	1.5	9	\$75.13	676	15	90			766
Ground Well & Cover	1	each	3.25	3.25	\$75.13	244	154.51	154.51			399
Electrical Trenching / Backfill for Underground Ground Cable	200	lnft	0.1	20	\$75.13	1,503					1,503
7F - E&I - Trenching	1	LS		65.6	\$75.13	4,929		2,583.56			7,512
26.00 - Electrical	1	LS		65.6	\$75.13	4,929		2,583.56			7,512
Electrical		lnft		65.6	\$75.13	4,929		2,583.56			7,512
350HP VT Well Pump - 3" PVC Conduit - U/G	380	lnft	0.1016	38.6	\$75.13	2,900	6.7988	2,583.56			5,484
3" RGS Conduit	20	lnft	0.2	4	\$75.13	301	12.63	252.6			553
3" RGS Conduit Seal Fitting "EYS"	4	each	1.4	5.6	\$75.13	421	128.3865	513.5461			934
3" RGS ELL	4	each	2	8	\$75.13	601	34.2529	137.0117			738
3" PVC Conduit - U/G	360	lnft	0.05	18	\$75.13	1,352	4.0086	1,443.08			2,795
3" PVC to RGS Adapter	4	each	0.3	1.2	\$75.13	90	3.08	12.32			102
U/G Electrical Warning Tape	180	lnft	0.01	1.8	\$75.13	135	1.25	225			360
350HP VT Well Pump - Electrical Trenching / Backfill for Underground Conduit	180	lnft	0.15	27	\$75.13	2,029					2,029
Electrical Trenching / Backfill for Underground Conduit	180	lnft	0.15	27	\$75.13	2,029					2,029
7G - E&I - Start-Up & Test	1	LS		62	\$75.13	4,658		380.08		2,400	7,438
26.00 - Electrical	1	LS		62	\$75.13	4,658		380.08		2,400	7,438
Electrical		lnft		62	\$75.13	4,658		380.08		2,400	7,438
480V Motor Boot Terminations & Rotation / Bump Test - 350HP VT Well Pump	1	each	15	15	\$75.13	1,127	162.89	162.89			1,290
480V Motor Boot Terminations & Rotation / Bump Test - 350HP VT Well Pump	1	each	15	15	\$75.13	1,127	162.89	162.89			1,290
480V Motor Boot Terminations & Rotation / Bump Test - for Refurbish 400HP VT Booster Pump	1	each	15	15	\$75.13	1,127	217.19	217.19			1,344
480V Motor Boot Terminations & Rotation / Bump Test - for Refurbish 400HP VT Booster Pump	1	each	15	15	\$75.13	1,127	217.19	217.19			1,344
Electrical Testing - for Refurbish 400HP VT Booster Pump	1	each			\$0.00				1,200.00	1,200	1,200
Electrical Testing - for Refurbish 400HP VT Booster Pump	1	each			\$0.00				1,200.00	1,200	1,200
Electrical Testing - for Size 6 Motor Starter 350HP VT Well Pump	1	each			\$0.00				1,200.00	1,200	1,200
Electrical Testing - for Size 6 Motor Starter 350HP VT Well Pump	1	each			\$0.00				1,200.00	1,200	1,200
Start-up Support - 2 Electricians for 2 Days	1	each	32	32	\$75.13	2,404					2,404
Start-up Support - 2 Electricians for 2 Days	1	each	32	32	\$75.13	2,404					2,404
Grand Total				1,495	526	112,291		118,620		3,400	233,934

APPENDIX G

OCWD AND IRWD MODEL SIMULATIONS TECHNICAL MEMORANDUM



TECHNICAL MEMORANDUM

DATE: February 11, 2021
TO: Ray Bennett (IRWD), Dave Youngblood (EOCWD)
FROM: Li Li (OCWD)
CC: Sonny Tran (City of Orange), Roy Herndon, John Kennedy, Greg Woodside

SUBJECT: Model Simulations for Proposed Well IRWD-OPA1 Pumping Increase and New EOCWD Well

1 Introduction

Orange County Water District (OCWD) staff understands that Irvine Ranch Water District (IRWD) is proposing to increase pumping at the Orange Park Acres well IRWD-OPA1 in the City of Orange, and East Orange County Water District (EOCWD) is proposing to install a new production well (“VanderWerff Well”) in the vicinity of the existing production wells EOCW-E and EOCW-W to improve reliability and accommodate its future water demand projection. The well locations are shown in Figure 1. Numerical simulations using the OCWD Basin Model were performed to predict the incremental water level decline (drawdown) resulting from the proposed additional pumping at well IRWD-OPA1 and the VanderWerff well, respectively, and/or concurrently in various future scenarios.

The purpose of this Technical Memorandum is to summarize the model input assumptions and the modeling results of these simulations.

2 Model Scenarios and Assumptions

2.1 Baselines

Two baseline conditions were formulated under two different basin accumulated overdraft conditions, one at 200,000 acre-feet (AF) and one at 400,000 AF. Based on the historical basin overdraft from the past 20 years, these two baselines represent representative high and low basin conditions within the operating range of the Orange County groundwater basin.

Both baselines include the existing facilities, i.e. recharge basins, five mid-basin injection wells in Centennial Park, Talbert Barrier and Alamitos Barrier injection wells, a proposed new Groundwater Replenishment System (GWRS) pipeline outlet to Burris

Model Simulations for Proposed Well IRWD-OPA1 Pumping Increase and EOCWD Well

Basin allowing GWRS water to be delivered to Riverview Basin, Santiago Basins and Santiago Creek, and all active production wells within the Basin Model domain.

General Assumptions:

1. The simulations were carried out for a 9-year simulation period. This was equivalent to the length of the original 1990-1999 transient model calibration period. Also, 9 years was found to be sufficiently long for water level changes to stabilize.
2. The simulations are balanced, i.e., total water into the groundwater basin equals total water out. Basin storage was kept relatively constant.
3. Groundwater Supply:
 - a. Projected average hydrology conditions: 52,000 AF per year (AFY) Santa Ana River (SAR) base flow recharge; 51,600 AFY SAR storm flow recharge;
 - b. 65,000 AFY Metropolitan Water District (MWD) imported water for Forebay recharge;
 - c. GWRS Final Expansion (GWRSFE) capacity of 134,000 AFY distributed to Talbert Barrier, mid-basin injection wells (MBI-1 through MBI-5), and Kraemer/Miller/Miraloma/La Palma/Burris/Riverview/Santiago Basins/Santiago Creek above Hart Park.

Unmeasured or incidental recharge for an average hydrology condition (totaling 55,400 AFY) was distributed to different areas such as areal recharge from precipitation, recharge along the mountain-front boundaries of the basin, and winter unmeasured storm flow recharge in the Santa Ana River and Santiago Creek. These components were kept the same throughout the 9-year simulation. This unmeasured or incidental recharge amount does not include model calculated inflow/outflow to Los Angeles County or through constant head model boundary conditions.

Actual measured monthly recharge volumes from SAR flows and imported water were adjusted and assigned to each OCWD recharge facility in the Anaheim and Orange Forebay areas. Monthly recharge adjustments were based on the statistical monthly water supply assumptions, but all recharge facilities were kept within their respective maximum operational capacities. GWRS water was assumed to be recharged into currently permitted basins, i.e., Miraloma, La Palma, Kraemer, and Miller Basins, as well as proposed future permitted recharge facilities, i.e, Burris, Riverview, Santiago Basins, and Santiago Creek above Hart Park. All facilities mentioned above except Miraloma and La Palma basins were assumed to also recharge water from sources other than GWRS. Miraloma and La Palma basins are dedicated to GWRS water recharge only.

4. Groundwater Production:

Model Simulations for Proposed Well IRWD-OPA1 Pumping Increase and EOCWD Well

The simulations used water year (WY) 2012-13 (July - June) groundwater production as a starting point. During WY 2012-13, there was no coastal pumping transfer or other large-scale pumping shifts. Therefore, it was a good representation of the overall pumping distribution reflecting actual seasonal demand in different areas of the basin. Only existing (as of 2020) active production wells were simulated (no planned/proposed/future wells). Minor adjustments were made to include new production wells installed after 2013 and eliminate wells that were permanently removed from service after 2013 or wells that will not be used in the future. Within the project area, production wells O-27 and IRWD-OPA1 were added, and SID-4 was removed from the simulation. The annual production amount was adjusted to maintain a balanced (negligible basin storage change) condition. The production data was then repeated for each of the nine years of the simulation.

The production adjustments were only applied to large system production wells excluding the water quality improvement (BEA-exempt) wells. These include several wells operated by City of Tustin, IRWD, and Mesa Water District that receive treatment as a part of water quality projects (e.g., removal of salts, nitrates, and amber tint). The production amounts from these wells are limited by well capacities, treatment plant capacities, and/or by agreements between the participating agencies and OCWD. Therefore, typical production rates were used for these wells and kept unchanged during the simulation. Production from small system or domestic wells, or irrigation wells, was also kept unchanged at a selected typical rate as those in WY 2012-13.

During each production adjustment, pumping capacity for existing production wells was assumed to not be a limitation for simulated production. The final adjusted total annual basin productions are 346,440 AF and 351,250 AF for the two baseline conditions at 200,000 and 400,000 AF overdraft condition, respectively.

Specific Assumptions:

- a. Actual recharge at the Talbert Barrier during WY 2011-12 and WY 2014-15 were used for the 200,000 and 400,000 AF baseline condition, respectively.
 - In WY 2011-12, the Talbert injection rates (20,736 AF) were considered to be representative of typical injection operations under a low accumulated overdraft (“high basin”) condition and were sufficient to maintain protective elevations. The basin accumulated overdraft in WY 2011-12 was approximately 179,000 AF.
 - In WY 2014-15, the Talbert injection rates (36,471 AF) were assumed to be representative of typical injection operations under a high accumulated overdraft (“low basin”) condition to maintain protective elevations; the basin accumulated overdraft in WY 2014-15 was approximately 381,000 AF.
 - These injection conditions were repeated for the nine-year duration of the simulations.

Model Simulations for Proposed Well IRWD-OPA1 Pumping Increase and EOCWD Well

- b. Historical production patterns were examined for a few wells in the vicinity of the project area. Annual production amounts and monthly distributions were selected for each of the following wells and not changed during production adjustment to balance the model simulations:
- **Wells EOCW-W and EOCW-E:** 890 AF annual production and monthly distribution from WY 2014-15, equally split between the two wells;
 - **Wells O-23 and O-24:** 4,044 AF annual production and monthly distribution from WY 2013-14;
 - **Well IRWD-OPA1:** 900 AF annual production, and monthly production in percentages listed below, per IRWD's recommendation:
 - Jan: 4.1%
 - Feb: 4.3%
 - Mar: 9.3%
 - Apr: 10.1%
 - May: 9.9%
 - Jun: 8.0%
 - Jul: 7.3%
 - Aug: 10.6%
 - Sep: 7.8%
 - Oct: 11.4%
 - Nov: 10.1%
 - Dec: 7.0%
- c. Santiago Basins and Santiago Creek were assumed to be recharged based on the most recent 10-year average rates of 26,080 and 2,472 AFY, respectively. Monthly recharge rates were determined based on the 10-year average monthly distribution from these facilities, as listed in Table 1. These recharge rates were repeated for the nine-year duration of the simulations.

Table 1: Monthly Recharge Rates at Santiago Basins and Santiago Creek

Month	Santiago Basins Monthly Recharge (AF)			Santiago Creek Monthly Recharge (AF)		
	10-year Average*	Max.*	Min.*	10-year Average*	Max.*	Min.*
Jan.	4,052	7,449	169	285	554	0
Feb.	3,932	7,010	260	193	385	0
Mar.	4,392	7,010	1,534	270	891	0
Apr.	3,648	6,403	882	212	699	0
May	2,794	6,052	589	236	701	0
Jun.	1,854	4,583	260	252	539	0
Jul.	1,223	3,499	184	193	577	0
Aug.	993	3,680	144	132	669	0
Sept.	657	2,648	138	227	806	0
Oct.	491	2,394	70	198	584	0
Nov.	397	2,584	0	159	535	0
Dec.	1,645	3,599	177	116	346	0

*: The average, maximum and minimum recharge are based on the data from the most recent ten years.

2.2 Future Scenarios

In order to evaluate groundwater level changes due to the proposed production increase at well IRWD-OPA1 and additional pumping from the VanderWerff well, both independently and concurrently, three future scenarios were simulated under each baseline condition, as shown below:

Table 2: Model Scenarios

Scenarios	Description	Overdraft (AF)	IRWD-OPA1 Pumping (AFY)	EOCWD Total Pumping (AFY)
1	Baseline 1	200,000	900*	890
1A	Increased IRWD-OPA1 production	200,000	3,200*	890
1B	Increased EOCWD production and New VanderWerff well	200,000	900*	1,050**
1C	Increased IRWD-OPA1 and EOCWD production and new VanderWerff well	200,000	3,200*	1,050**
2	Baseline 2	400,000	900*	890
2A	Increased IRWD-OPA1 production	400,000	3,200*	890
2B	Increased EOCWD production and New VanderWerff well	400,000	900*	1,050**
2C	Increased IRWD-OPA1 and EOCWD production and New VanderWerff well	400,000	3,200*	1,050**

* IRWD's recommendation

** Based on the EOCWD Retail Zone Population and Demands Projections 2020-2045

All assumptions for the future scenarios were kept the same as their corresponding baselines, except the pumping from well IRWD-OPA1 and/or total EOCWD pumping with/without the VanderWerff well, as listed above.

In Scenarios 1A, 1C, 2A, and 2C, with increased IRWD-OPA1 pumping, the 3,200 AFY proposed future pumping was uniformly distributed among 12 months with 8.333% or 266.667 AF per month per IRWD's recommendation.

In Scenarios 1B, 1C, 2B, and 2C, with the VanderWerff well, total proposed future pumping of 1,050 AF was equally divided among the three wells (EOCW-W, EOCW-E and the VanderWerff well) following the monthly distribution from WY 2014-15. Based on the location description from EOCWD staff, the VanderWerff well was placed in the same model grid cell as EOCWD-W and assumed to have the same screened interval as existing wells EOCW-W and EOCW-E for this analysis.

3 Model Results

Results from the eight model simulations completed for this drawdown analysis are summarized below:

Baseline 1 and Scenarios 1A, 1B, and 1C

As discussed previously, Baseline 1 at 200,000 AF accumulated overdraft represents a “high basin” condition. It includes IRWD-OPA1 pumping of 900 AFY, and total EOCWD pumping of 890 AFY from the two existing wells. The total adjusted groundwater production to remain a balanced model was 361,440 AF. A model-simulated groundwater elevation contour map (Principal Aquifer) from this baseline, representing October 31, the end of the 9-year model simulation, is shown in Figure 2.

Scenario 1A had the same background conditions as Baseline 1 except that IRWD-OPA1 pumping was increased to 3,200 AFY from 900 AFY, so that the incremental effect of the increased pumping could be quantified.

Figure 3 shows the difference in simulated groundwater elevations between Scenario 1A and Baseline 1, representing the incremental water level change due solely to the proposed IRWD-OPA1 pumping increase of 2,300 AFY above the baseline. A negative water level change represents a decline in simulated water levels from Baseline 1 to Scenario 1A. The model-predicted water level change in Figure 3 represents the end of the 9-year model simulation. The maximum water level change at the IRWD-OPA1 well was approximately -15.2 feet (15.2 feet of drawdown) and reduced radially outward from the site. The drawdown was close to 6 feet at the nearest large system production well O-23, and approximately 4.5 feet drawdown at wells EOCW-W and EOCW-W.

Similar to Scenario 1A, Scenario 1B had the same assumptions as Baseline 1, except that the VanderWerff well was added, and the total combined pumping from all three EOCWD wells was increased to 1,050 AF from 890 AF. The incremental changes in groundwater elevations can be quantified due solely to the extra 160 AFY production.

Figure 4 shows the difference in simulated groundwater elevations between Scenario 1B and Baseline 1, representing the groundwater level decline (drawdown) resulting from the VanderWerff well with additional 160 AFY groundwater pumping above the baseline. The model-predicted water level change in Figure 4 represents the end of the 9-year model simulation. The maximum water level change at the EOCWD wells was approximately -1.4 feet (1.4 feet of drawdown) and reduced radially outward from the site. Less than one foot of drawdown was calculated at wells O-23 and IRWD-OPA1 in this scenario.

Scenario 1C had the same inputs as Baseline 1 except that it included both the pumping increase at well IRWD-OPA1 and the pumping increase associated with the proposed EOCWD VanderWerff well. Figure 5 shows the difference in simulated groundwater elevations between Scenario 1C and Baseline 1, representing the incremental water level change due to both the additional 2,300 AFY pumping from well IRWD-OPA1 and the additional 160 AFY pumping from EOCWD above the baseline.

Model Simulations for Proposed Well IRWD-OPA1 Pumping Increase and EOCWD Well

The model-predicted water level change in Figure 5 represents the end of the 9-year model simulation. The maximum drawdown at well IRWD-OPA1 was approximately 15.5 feet and approximately 5 feet at the EOCWD wells. Table 3 summarizes the model-predicted drawdown at these locations. The calculated drawdown at well O-23 was approximately 6 feet.

Table 3: Model-Simulated Drawdown at Production Wells

Production Wells	Maximum Drawdown (feet)					
	Scenario 1A With IRWD-OPA1 @3,200 AFY	Scenario 1B With EOCWD @1,050 AFY	Scenario 1C With IRWD-OPA1 @3,200 AFY and EOCWD @1,050 AFY	Scenario 2A With IRWD-OPA1 @3,200 AFY	Scenario 2B With EOCWD @1,050 AFY	Scenario 2C With IRWD-OPA @3,200 AFY and EOCWD @1,050 AFY
IRWD-OPA1	15.2	<1	15.5	16.0	<1	16.3
O-23	5.9	<1	6.3	6	<1	6.7
EOCW-W, EOCW-E	4.5	1.4	5	4.5	1.5	5

To illustrate simulated groundwater levels over time, Figures 6, 7, and 8 show the simulated water levels for the last 12 months (of model year 9) of all four simulations at three different locations:

1. well IRWD-OPA1,
2. well O-23 (mid-point between IRWD-OPA1 and EOCWD wells),
3. wells EOCW-W and EOCW-E.

The simulated water levels over a 12-month period show a typical seasonal cycle with low levels in the summer/fall and high levels in the winter/spring. There was little monthly variation in the simulated water level change (drawdown) due to the uniform proposed monthly pumping at IRWD-OPA1.

Baseline 2 and Scenarios 2A, 2B, and 2C

In Baseline 2, under a “low basin” condition with 400,000 AF accumulated overdraft, the volume of Talbert Barrier injection required to control seawater intrusion was increased approximately 16,000 AFY from Baseline 1, “high basin” condition. Consequently, the amount of water available to be recharged in the Anaheim forebay was decreased in order to keep the total water supply unchanged. However, the recharge in the Santiago Basins area was kept the same for all scenarios under the different overdraft conditions. The total groundwater production was adjusted to 351,250 AFY to maintain minimum basin storage change during the 9-year model simulation period.

Figure 9 shows the model-simulated groundwater elevation contour map from Baseline 2, in the Principal Aquifer, representing October 31, the end of the 9-year model simulation.

Scenarios 2A, 2B, and 2C had the same assumptions and inputs as Baseline 2 except:

Model Simulations for Proposed Well IRWD-OPA1 Pumping Increase and EOCWD Well

- Scenario 2A: IRWD-OPA1 pumping was increased to 3,200 AFY from 900 AFY
- Scenario 2B: the VanderWerff well was added, and the total pumping from EOCWD was increased to 1,050 AFY from 890 AFY
- Scenario 2C: IRWD-OPA1 pumping was increased to 3,200 AFY, and EOCWD pumping was increased to 1,050 AFY with the VanderWerff well.

Figures 10, 11, and 12 show the difference in simulated groundwater elevations at the end of the 9-year model simulation between the three scenarios (2A, 2B and 2C) and Baseline 2, respectively, representing the incremental water level change due to the changes to IRWD-OPA1 and/or EOCWD pumping in each scenario.

Figures 13, 14, and 15 show the simulated water levels for the last 12 months (of model year 9) of all four simulations at three different locations (IRWD-OPA1, well O-23, and wells EOCW-W and EOCW-E).

The maximum simulated water level change (drawdown) from Scenario 2A to Baseline 2 was approximately 16 feet, near well IRWD-OPA1 due to the proposed 2,300 AFY pumping increase. The drawdown gradually decreases farther away from the well, to approximately less than 5 feet near wells EOCW-W and EOCW-E.

The additional 160 AFY pumping associated with the proposed VanderWerff well in Scenario 2B resulted in approximately 1.5 feet of drawdown near wells EOCW-E and EOCW-W, and approximately 0.5 foot or less water level change near wells O-23 and IRWD-OPA1.

The simulated water level difference between Scenario 2C and Baseline 2 is the most among the three scenarios, as it represents the combined effects of Scenarios 2A and 2B. The maximum drawdown of 16.3 feet occurred at well IRWD-OPA1, radially decreased farther away from this well, to approximately 5 feet at EOCWD wells.

Table 3 summarizes the model-predicted drawdown at these locations.

Similar to the 200,000 AF overdraft simulations, model results for the 400,000 AF overdraft condition show low water levels in the summer/fall and high water levels in the winter/spring. Likewise, there were no significant seasonal variations in simulated drawdown from these scenarios due to the uniform proposed monthly pumping at IRWD-OPA1.

4 Summary

The simulated incremental water level change or drawdown caused by the proposed 2,300 AFY increase in well IRWD-OPA1 pumping alone, or the proposed additional 160 AFY pumping associated with the proposed EOCWD VanderWerff well alone, or the combination the of the two, are essentially the same (within 1 foot) under “high basin”

Model Simulations for Proposed Well IRWD-OPA1 Pumping Increase and EOCWD Well

(200,000 AF accumulated overdraft) and “low basin” conditions (400,000 AF accumulated overdraft).

The maximum drawdown simulated in the Principal aquifer caused by the proposed IRWD-OPA1 pumping increase of 2,300 AFY was approximately 15-16 feet at the IRWD-OPA1 well.

The maximum drawdown simulated in the Principal aquifer caused by the 160 AFY additional pumping associated with the proposed EOCWD VanderWerff well was approximately 1.5 feet at the EOCWD wells.

The maximum drawdown simulated in the Principal aquifer caused by both the proposed additional 2,300 AFY pumping from well IRWD-OPA1 and the additional 160 AFY pumping from EOCWD was approximately 16 feet at the IRWD-OPA1 well.

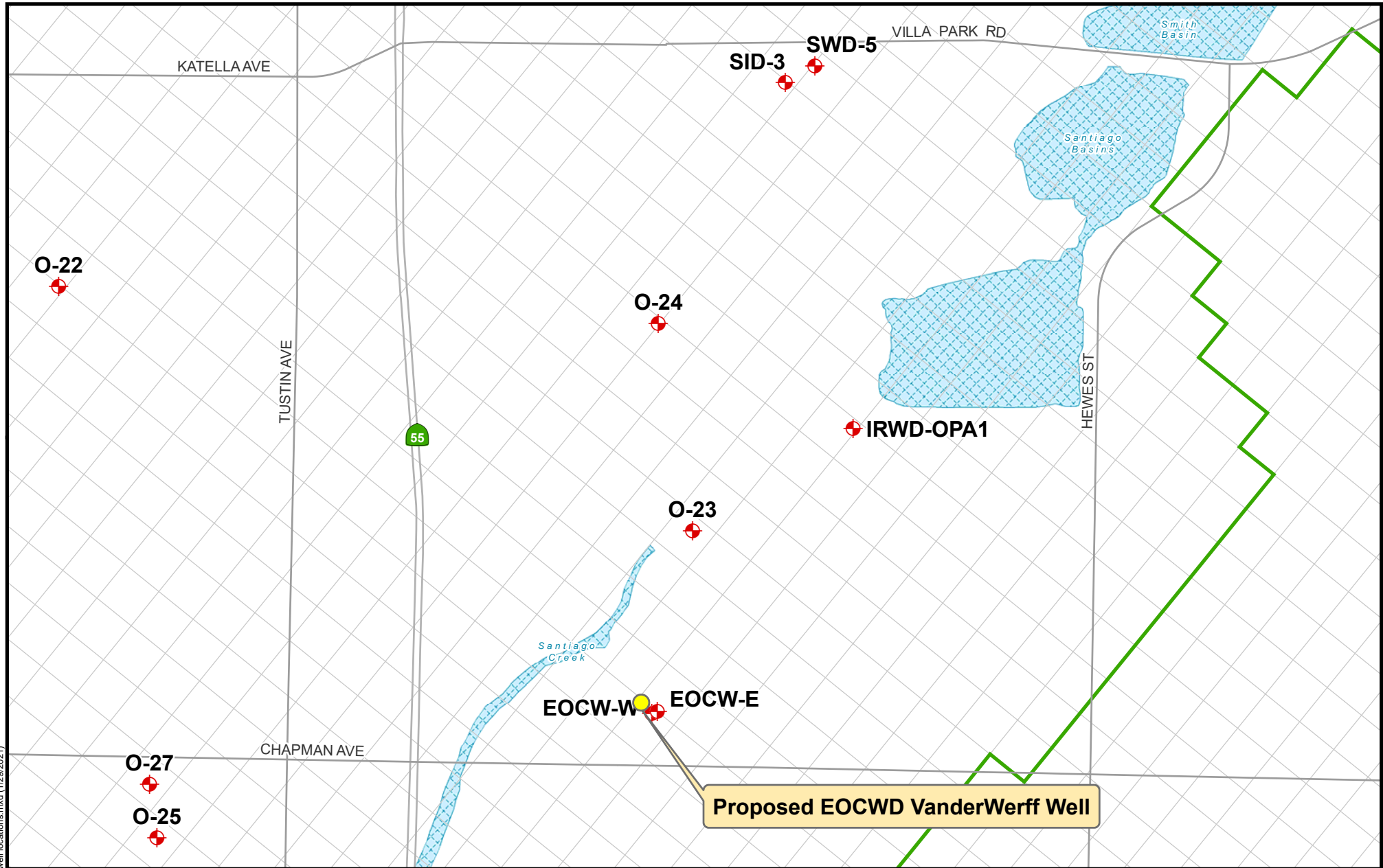

Path: F:\drawdown in Orange maps\Fig1_well locations.mxd (1/29/2021)



-  Active Large-System Production Well
-  Basin Model Boundary -- Principal Aquifer
-  Basin Model Grid



Figure 1
Well Locations





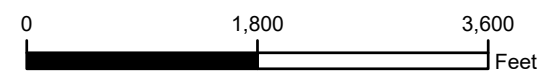
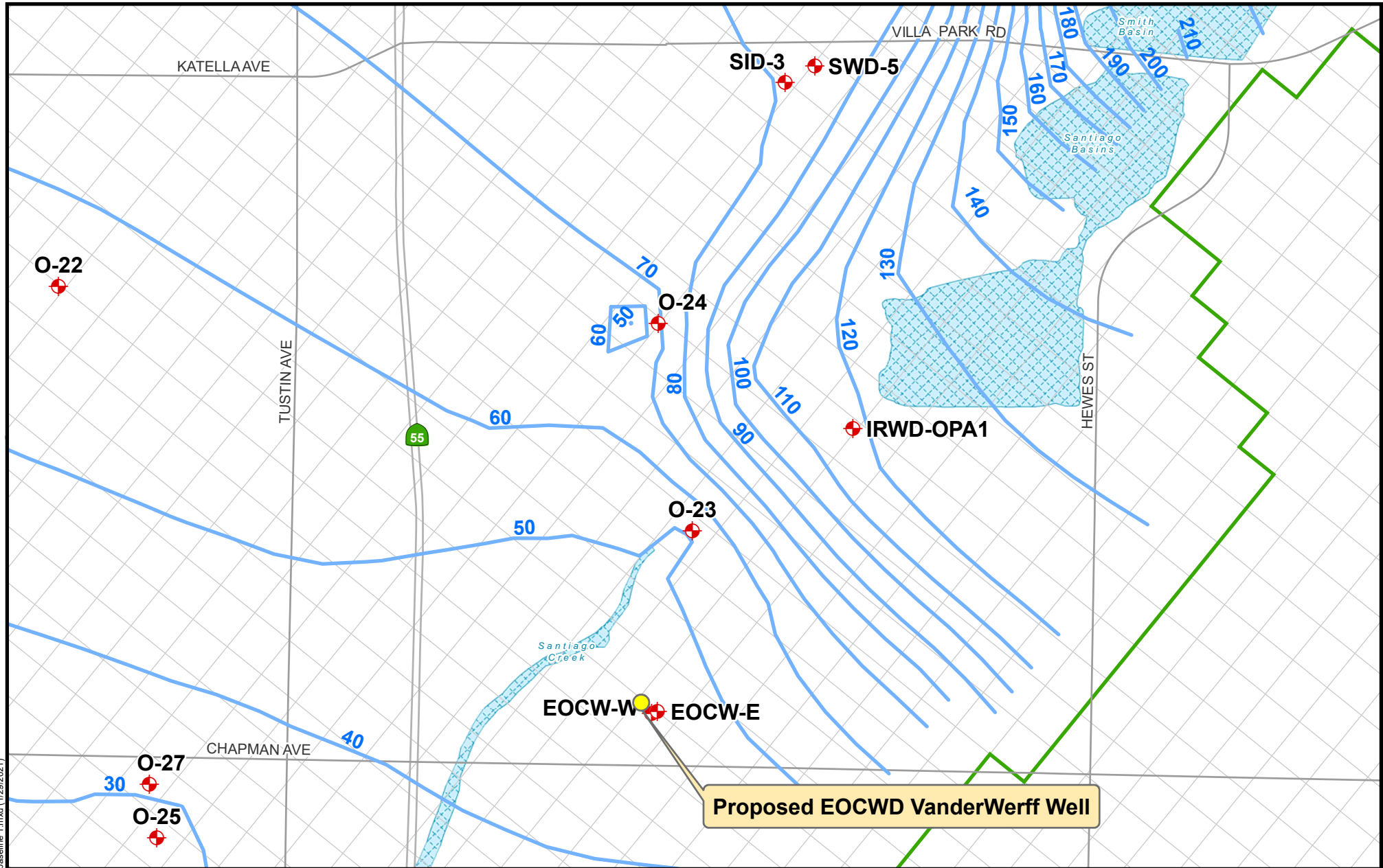



-  Active Large-System Production Well
-  Simulated Groundwater Elevations (feet msl)
-  Basin Model Boundary -- Principal Aquifer
-  Basin Model Grid



Figure 2
Baseline 1: Simulated Groundwater Elevations
Principal Aquifer



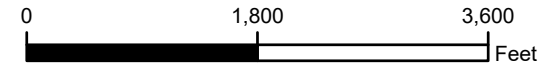
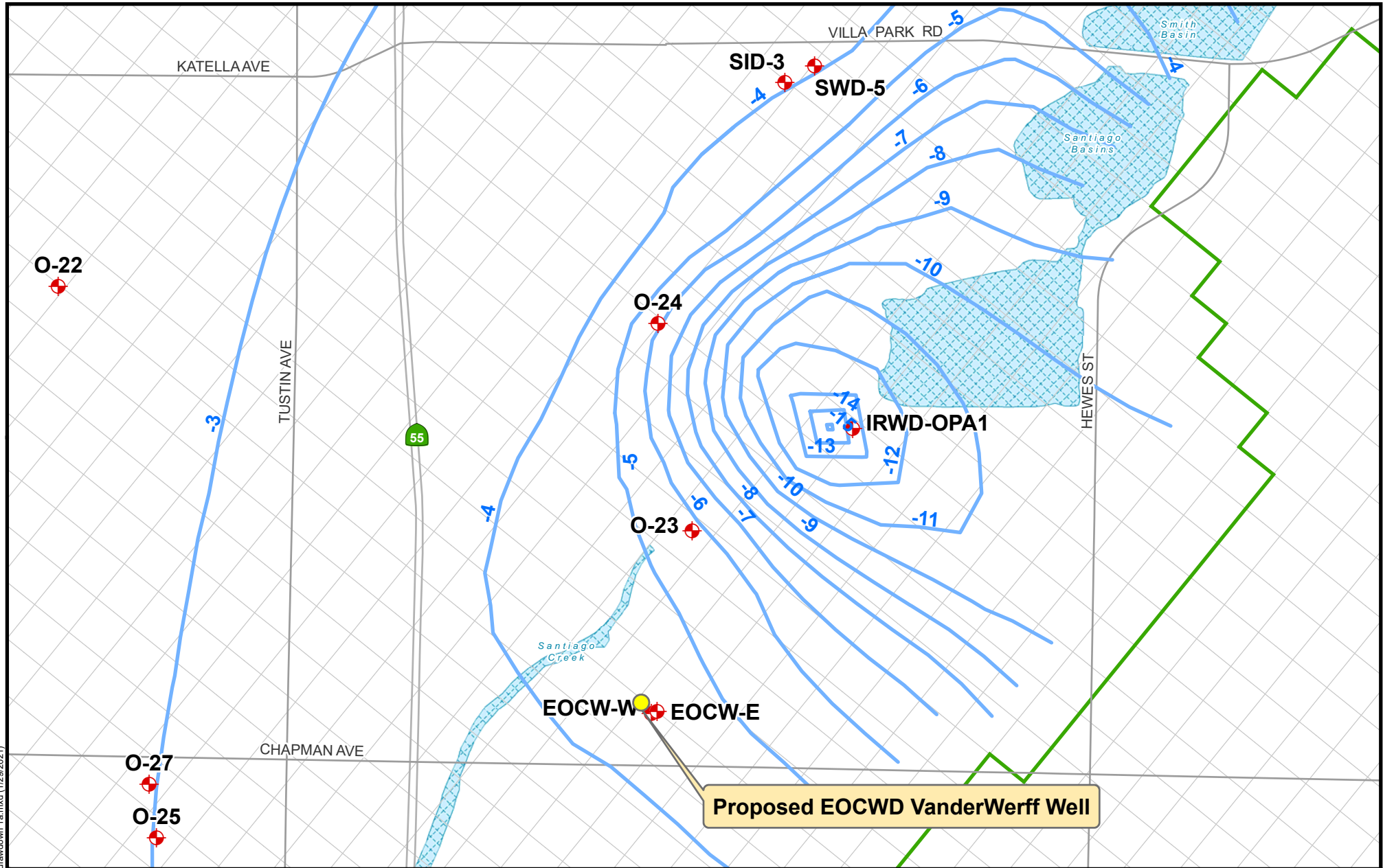

- Active Large-System Production Well
- Simulated Water Level Change (Drawdown) in Feet
- Basin Model Boundary -- Principal Aquifer
- Basin Model Grid



Figure 3
Simulated Groundwater Elevation Change
(Scenario 1A - Baseline 1 in Principal Aquifer)

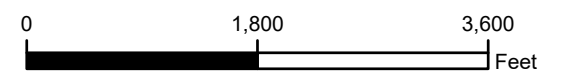

Path: F:\drawdown in Orange.mxd\Fig3_drawdown_1a.mxd (1/29/2021)

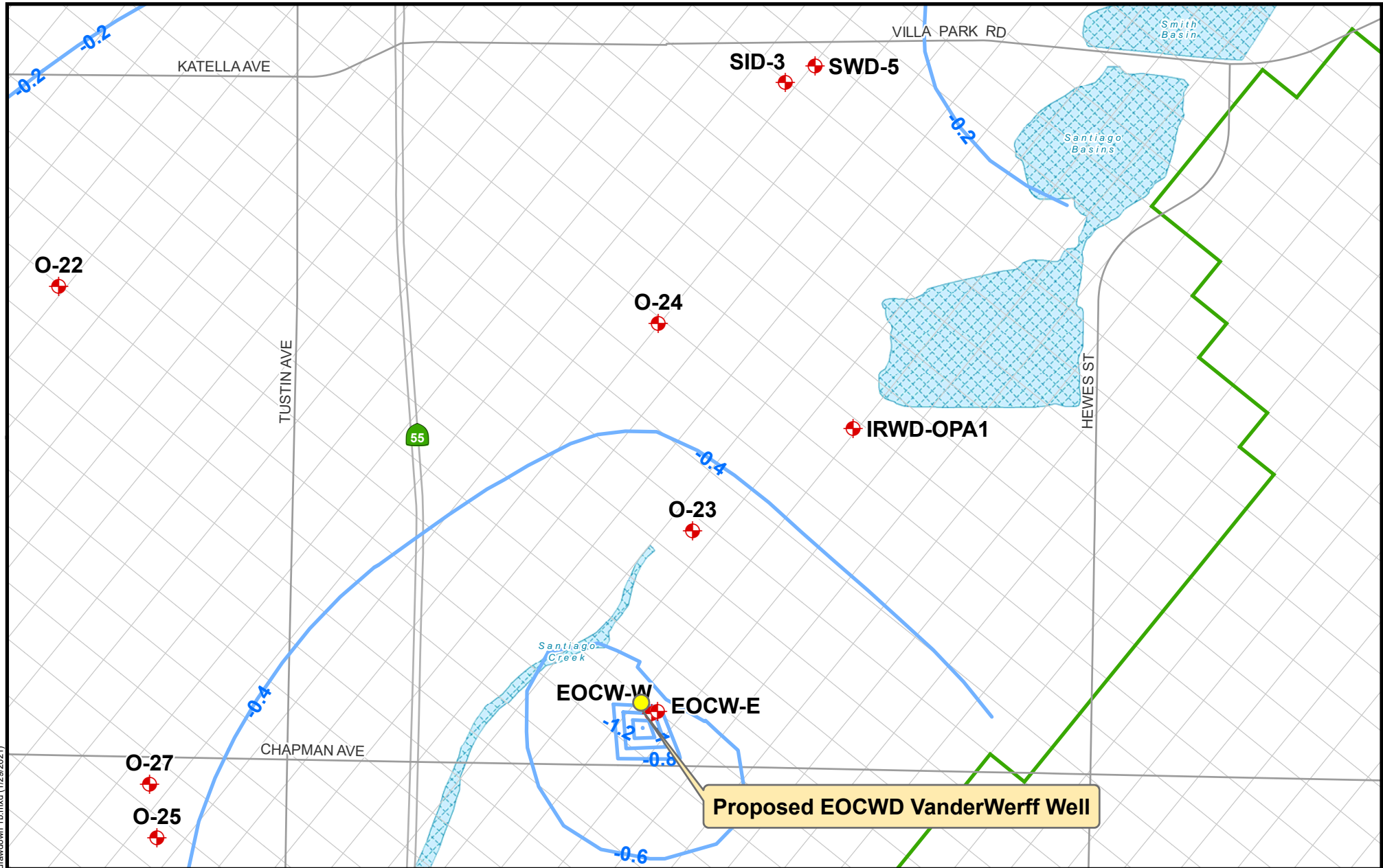

Path: F:\drawdown in Orange.mxd\Fig4.drawdown_1b.mxd (1/29/2021)

- ⊕ Active Large-System Production Well
- Simulated Water Level Change (Drawdown) in Feet
- Basin Model Boundary -- Principal Aquifer
- Basin Model Grid



Figure 4
Simulated Groundwater Elevation Change
(Scenario 1B - Baseline 1 in Principal Aquifer)

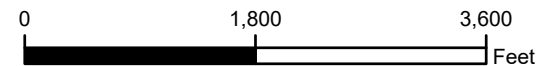

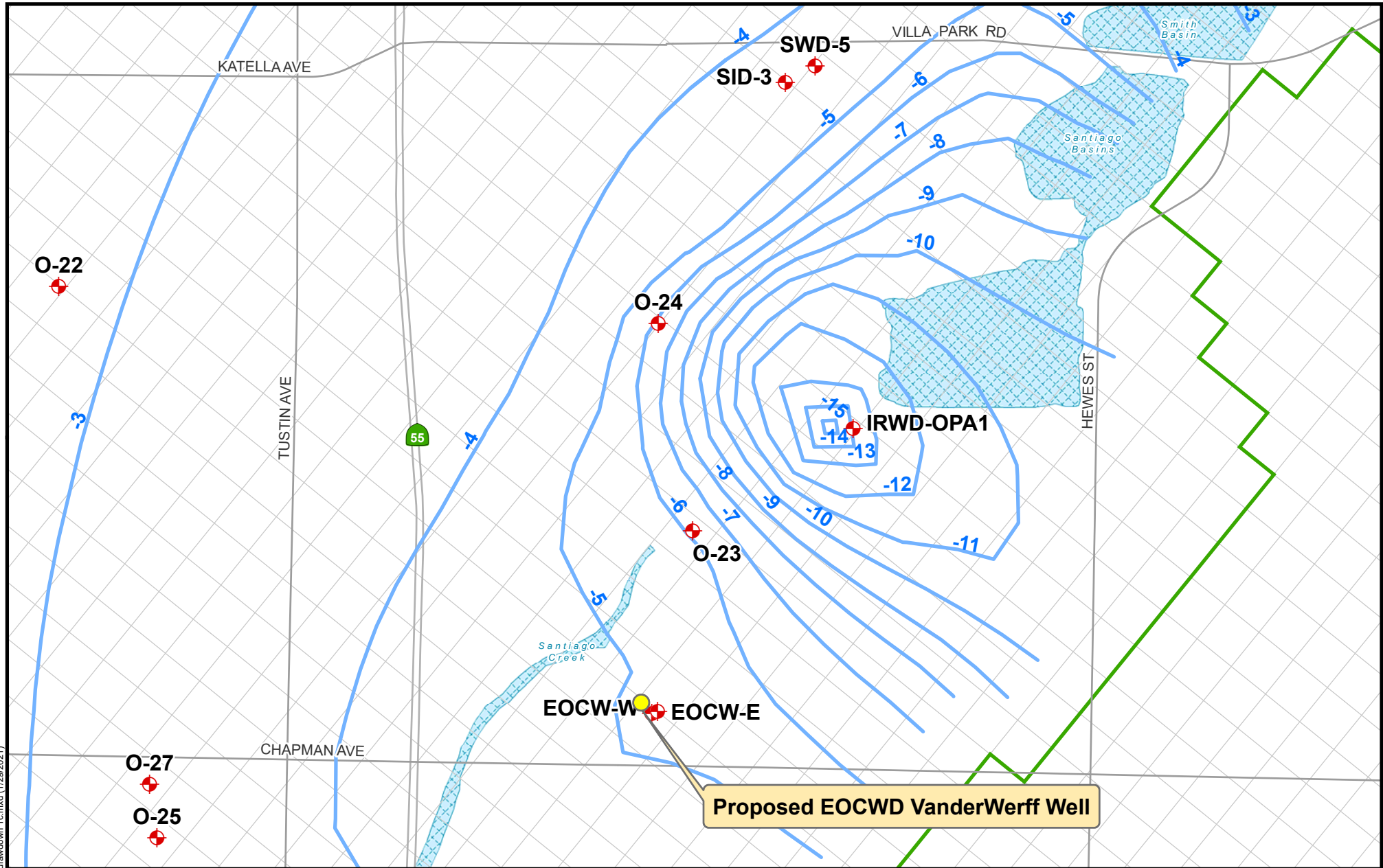





-  Active Large-System Production Well
-  Simulated Water Level Change (Drawdown) in Feet
-  Basin Model Boundary -- Principal Aquifer
-  Basin Model Grid



Figure 5
Simulated Groundwater Elevation Change
(Scenario 1C - Baseline 1 in Principal Aquifer)

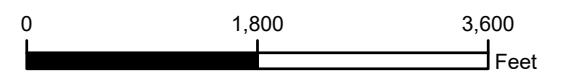

Figure 6

Simulated Groundwater Elevations at Well IRWD-OPA1

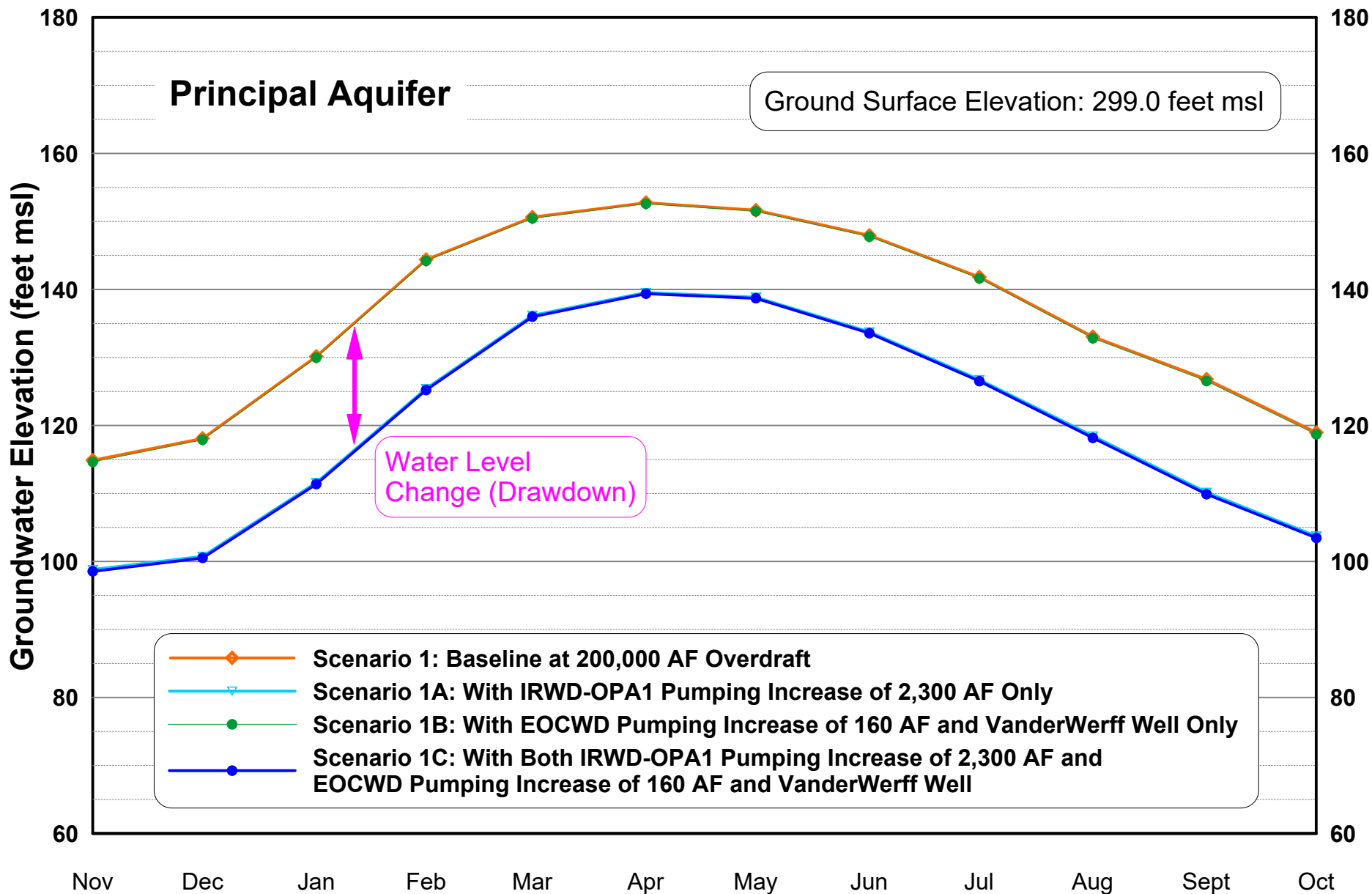

Figure 7

Simulated Groundwater Elevations at Well O-23

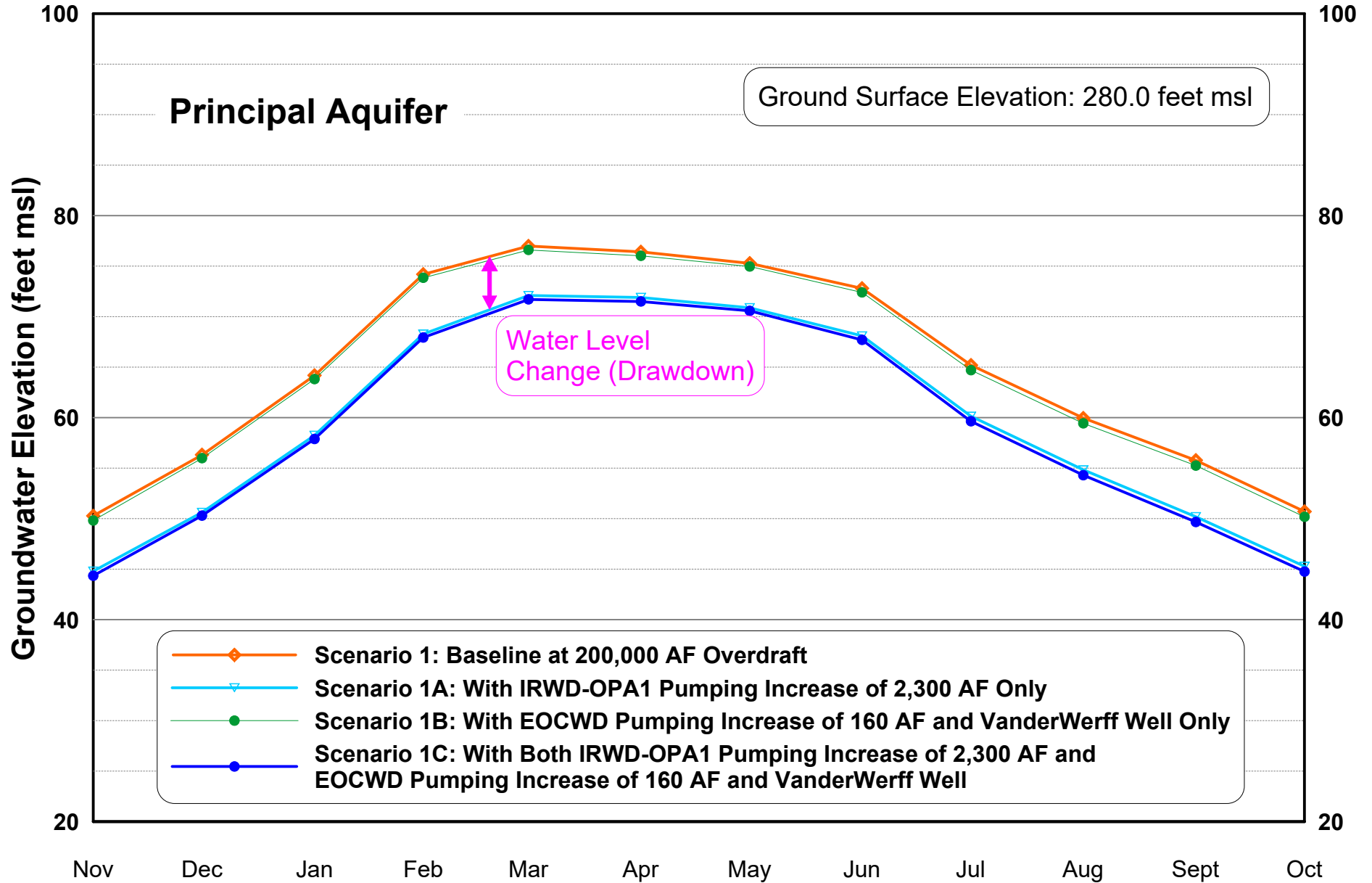
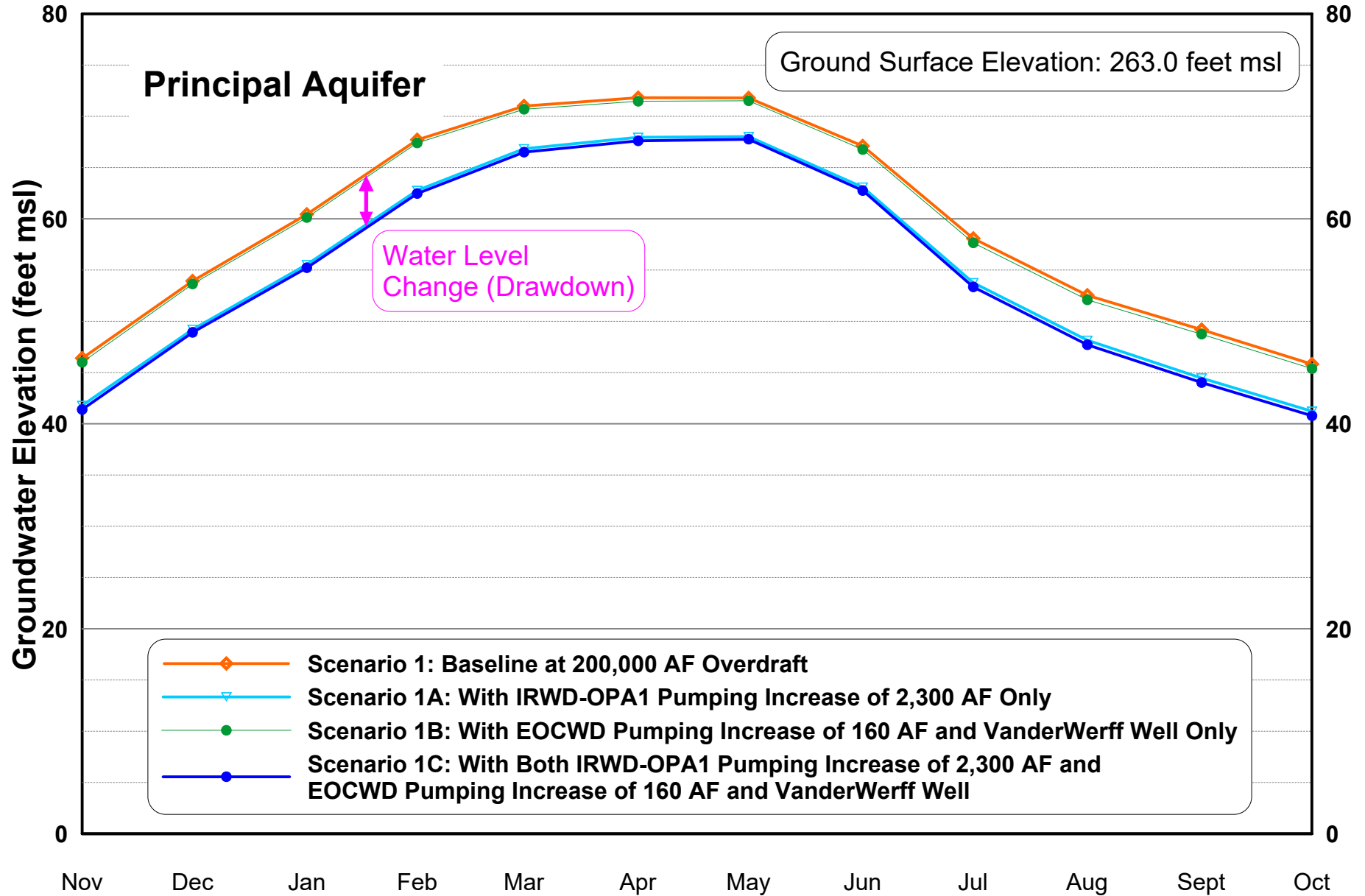
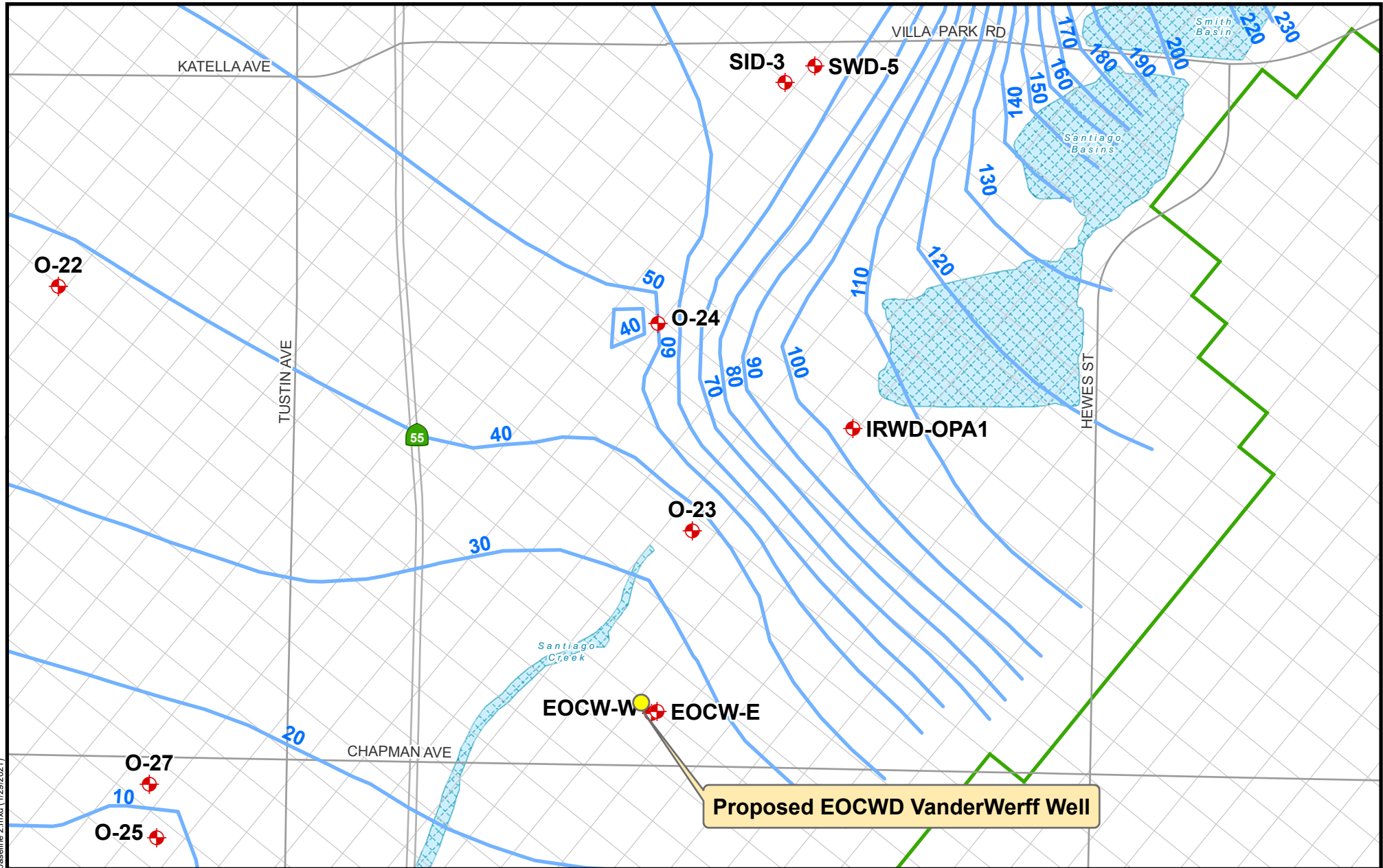

Figure 8
Simulated Groundwater Elevations at Wells EOCW-W and EOCW-E





Path: F:\drawdown in Orange maps\Fig9 baseline 2.mxd (1/29/2021)





-  Active Large-System Production Well
-  Simulated Groundwater Elevations (feet msl)
-  Basin Model Boundary -- Principal Aquifer
-  Basin Model Grid



Figure 9
Baseline 2: Simulated Groundwater Elevations
Principal Aquifer





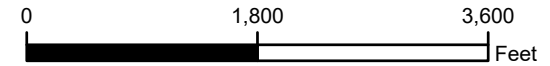
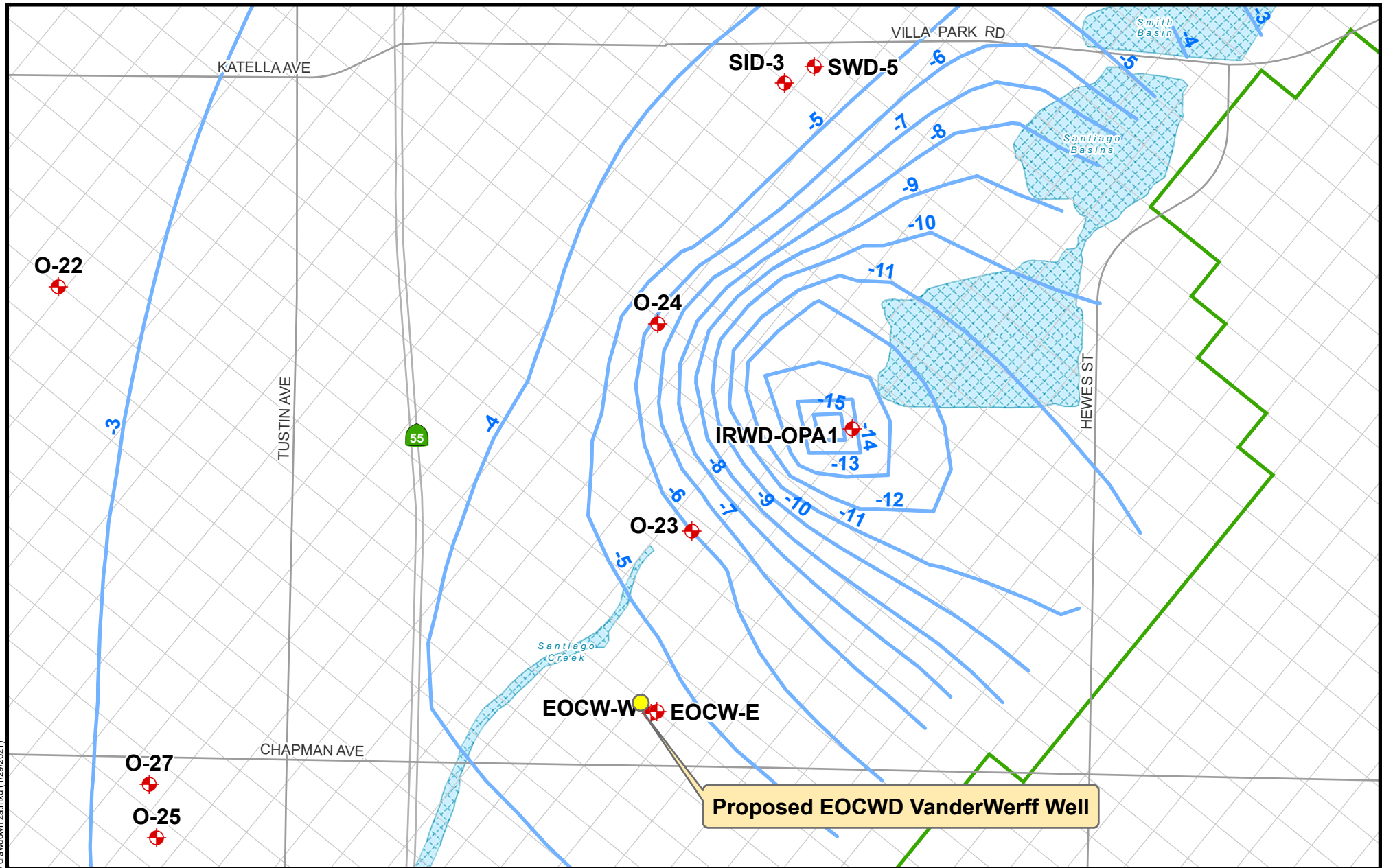



-  Active Large-System Production Well
-  Simulated Water Level Change (Drawdown) in Feet
-  Basin Model Boundary -- Principal Aquifer
-  Basin Model Grid



Figure 10
Simulated Groundwater Elevation Change
(Scenario 2A - Baseline 2 in Principal Aquifer)





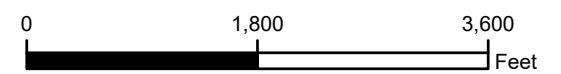
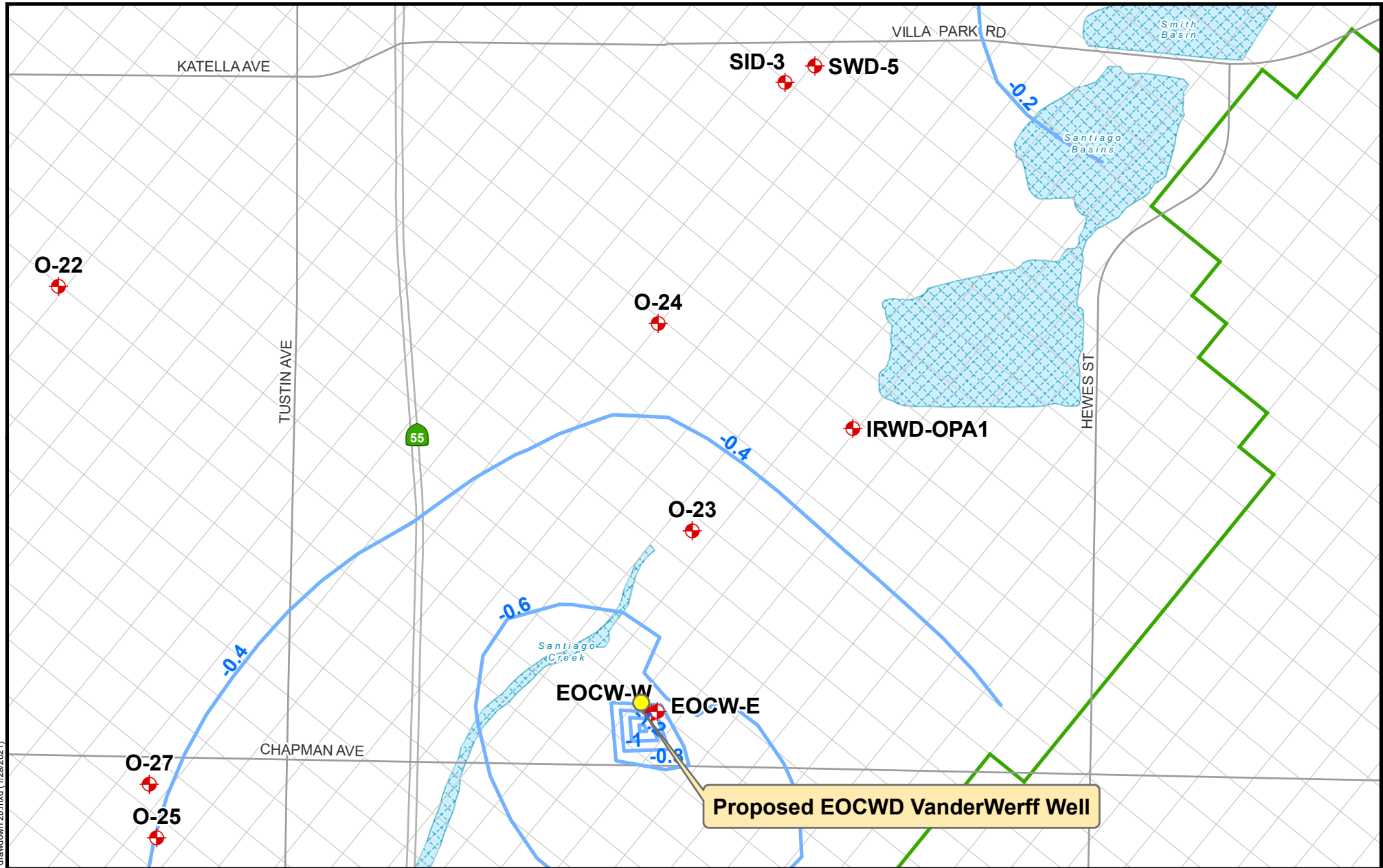



-  Active Large-System Production Well
-  Simulated Water Level Change (Drawdown) in Feet
-  Basin Model Boundary -- Principal Aquifer
-  Basin Model Grid



Figure 11
Simulated Groundwater Elevation Change
(Scenario 2B - Baseline 2 in Principal Aquifer)



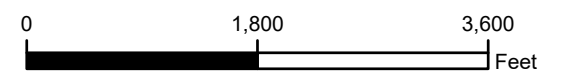
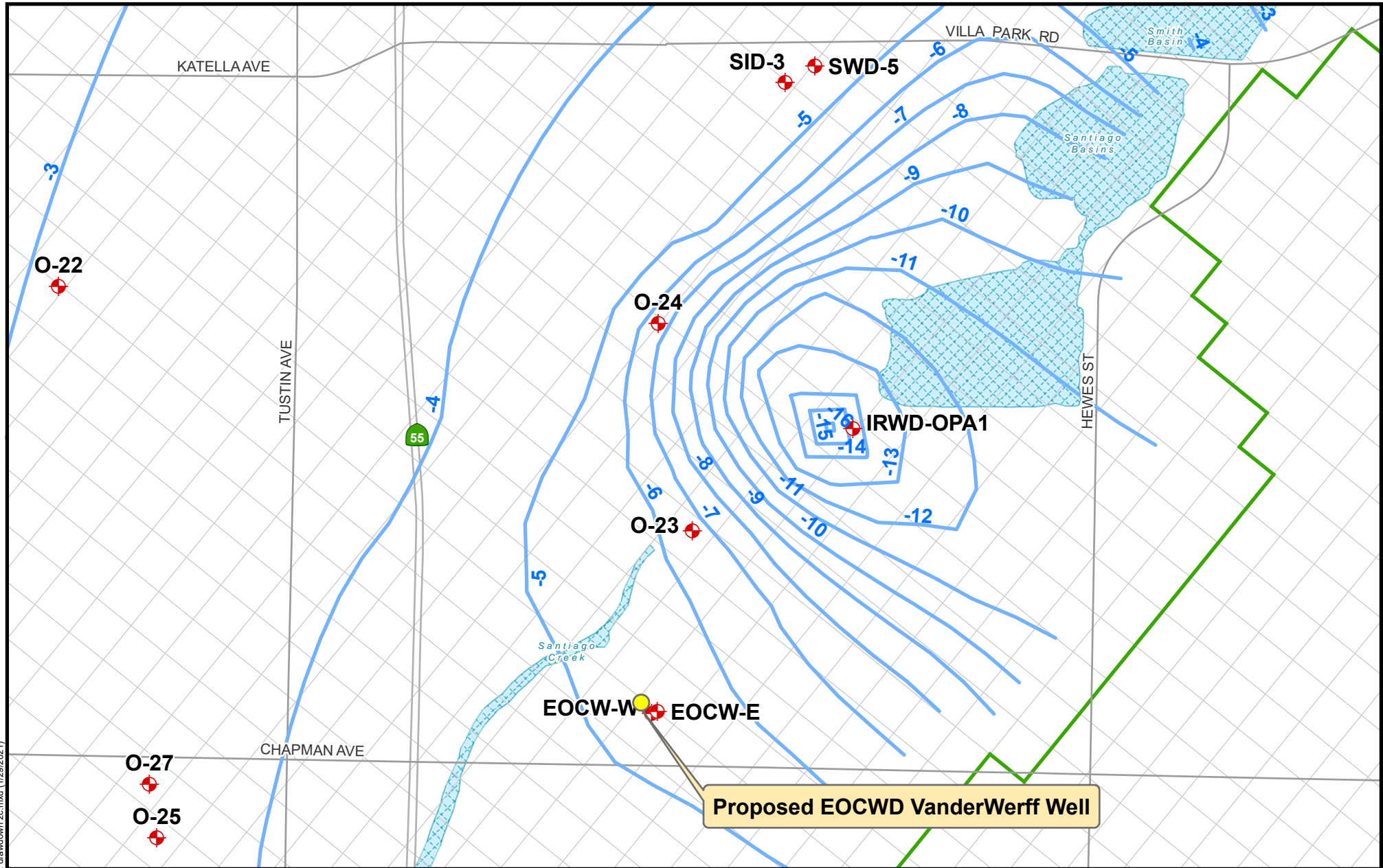

- Active Large-System Production Well
- Simulated Water Level Change (Drawdown) in Feet
- Basin Model Boundary -- Principal Aquifer
- Basin Model Grid



Figure 12
Simulated Groundwater Elevation Change
(Scenario 2C - Baseline 2 in Principal Aquifer)

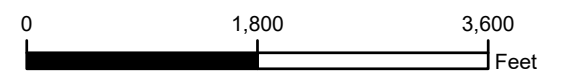

Figure 13 Simulated Groundwater Elevations at Well IRWD-OPA1

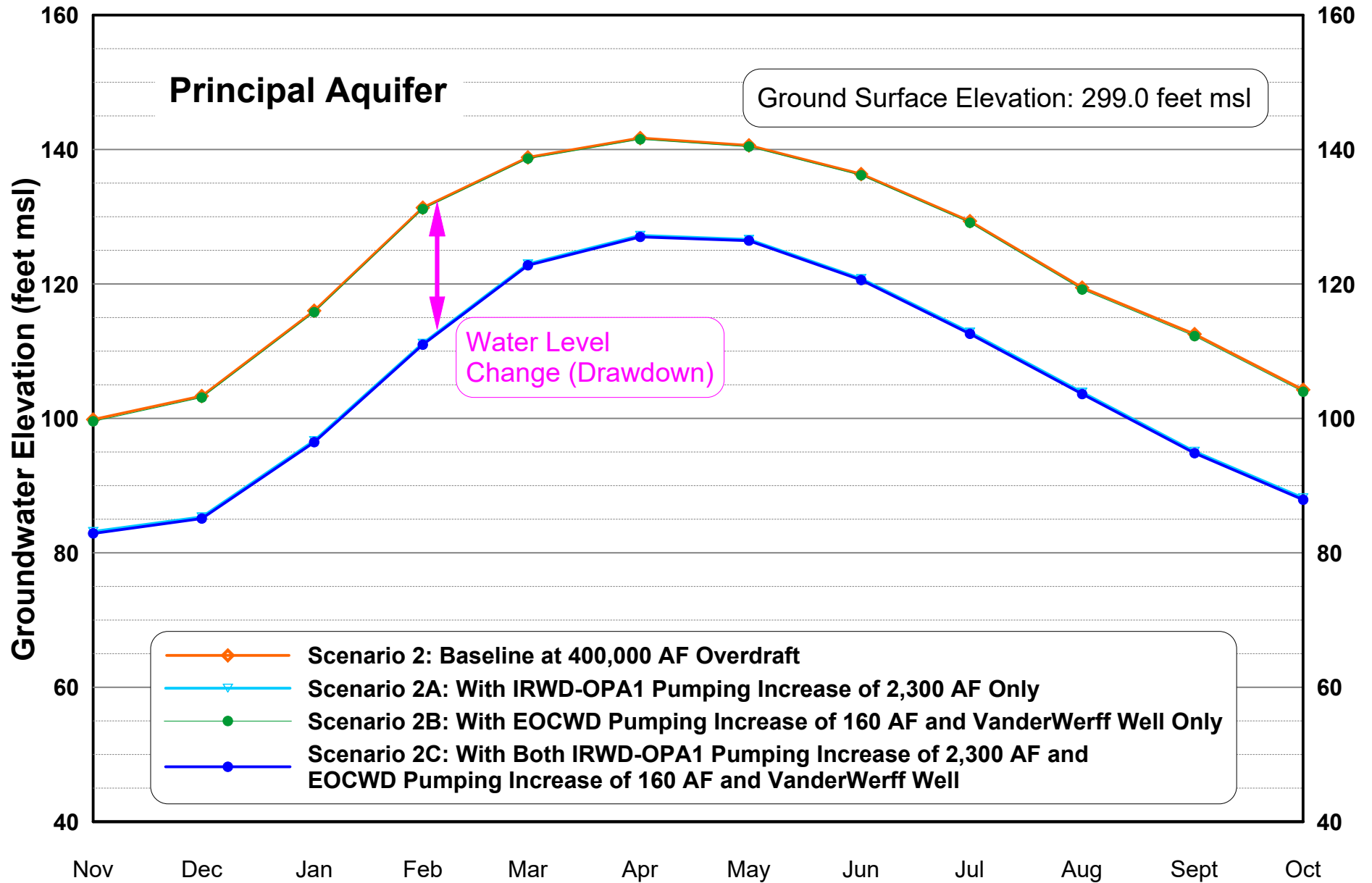

Figure 14

Simulated Groundwater Elevations at Well O-23

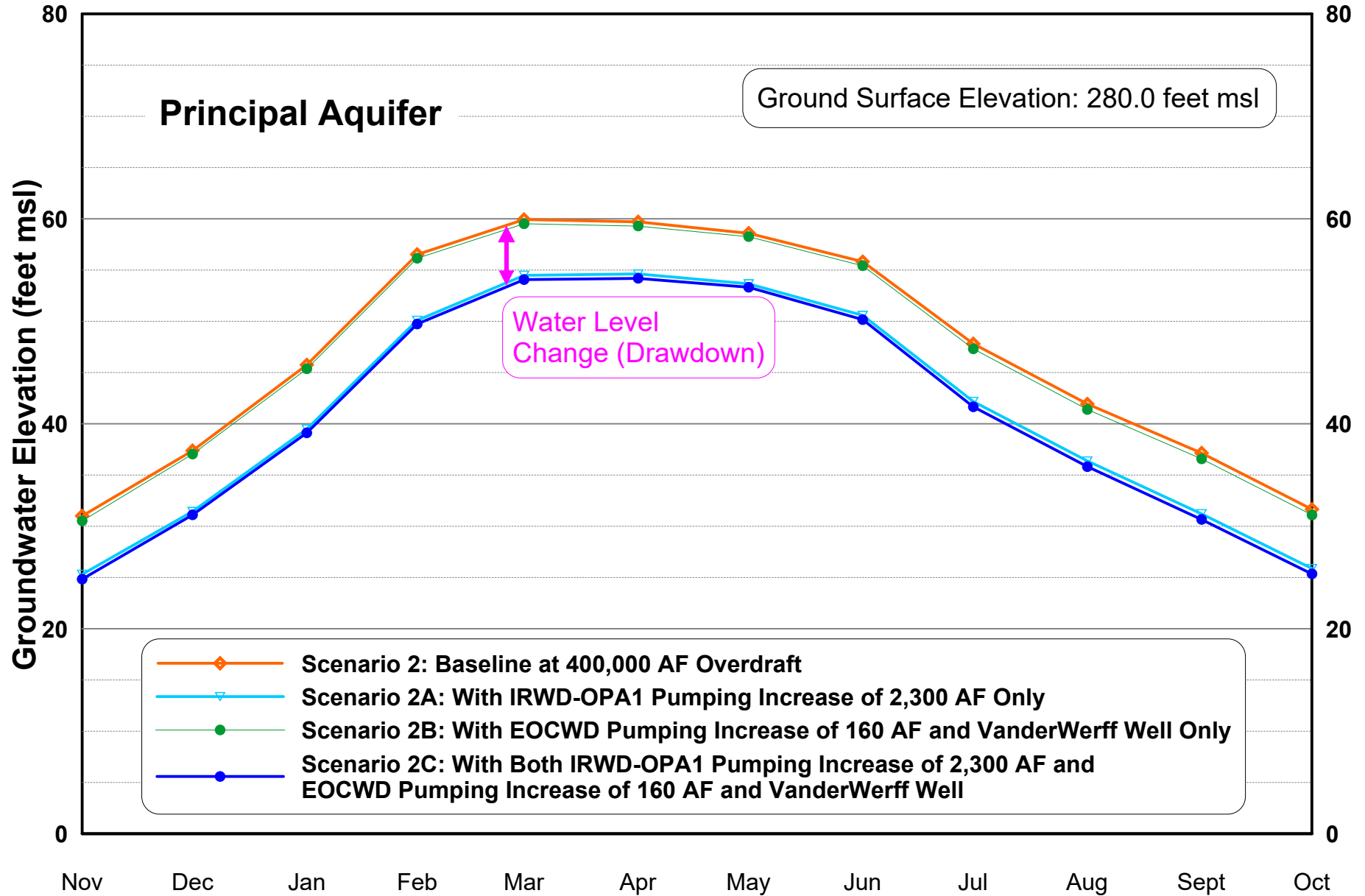

Figure 15
Simulated Groundwater Elevations at Wells EOCW-W and EOCW-E

