

Setting Up a Drip System

Written by
JEAN MARSH
GARDEN DESIGN
landscapes thoughtfully
designed for the homeowner
jeanmarshdesign@aol.com

Drip Irrigation - The Basic System

- ❑ **WHAT IT IS:** A system that delivers water more efficiently than any other type of irrigation. Applies water in very small amounts over a longer period of time. Promotes root development and general plant health. Minimizes maintenance. Excellent homeowner project for new or retro-fit situations.
- ❑ **GPH – GALLONS PER HOUR:** This is the unit of measure used for drip irrigation.
- ❑ **GPM – GALLONS PER MINUTE:** This is the unit of measure used for sprinkler irrigation.
- ❑ **PRESSURE REGULATORS:** Drip systems run on low pressure between 15 & 35 PSI. A pre-set pressure regulator is necessary.
- ❑ **FILTERS:** Filtration is recommended. A 150 or 200 mesh screen filter will do the job. Typical is a 'Y' filter or a 'T' filter.

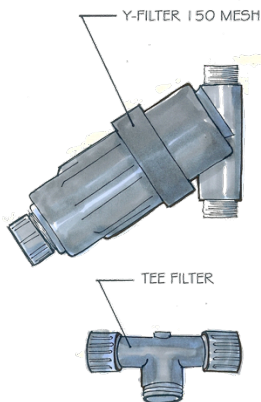

❑ **PIPE OR TUBING:** The pipe commonly used for drip systems is polyethylene, often called 'poly tubing'. Standard mainline tubing is usually 1/2 inch (0.600" ID x 0.700 OD). Stick with commercial grade products from irrigation supply stores. This poly supply line can be buried, but more often is laid above ground. Use garden clippers to cut tubing. No glue of any kind is used to fit tubing to connectors.

❑ **SPAGHETTI TUBING:** This is a common term for the smaller dimension tubing that is 1/4 inch (0.170 ID x 0.25 OD). This tubing is an essential component in a drip system, but too much of it becomes a maintenance headache. Limit the use of 1/4 tubing to no more than 12 inches in length per run.

- ❑ **LENGTH OF RUN LIMITS:** 1/2 inch tubing can run up to 200 linear ft. 1/4 inch tubing should not exceed 19 ft in length.
- ❑ **MAXIMUM FLOW CAPACITY:** 1/2 tubing can handle a maximum of 240 GPH or 4 GPM. 1/4 tubing can handle a maximum flow of 30 GPH or 0.5 GPM
- ❑ **CONNECTORS:** These are the fittings that connect pipe – tee, ell (90), or couplers. They come in sizes to match the pipe; 1/2" or 1/4". For 1/2" tubing, compression fittings are preferred over barbed fittings. Barbed fittings fit *inside the tubing* and on a hot day the connection can blow apart due to the fact that the tubing gets soft in the heat. Compression fittings where the *tubing fits inside the fitting* solve this problem. Smaller 1/4" tubing typically is fitted together with barbed fittings – these will not blow apart. Connectors only fit pieces of tubing together – they are NOT flow controls.
- ❑ **FLOW CONTROLS:** These are the components that control the amount of water that is delivered. The flow is rated at GPH – gallons per hour. Flow controls include emitters, drippers (same thing as emitters), bubblers & sprayers. A word about bubblers & sprayers: these components typically sit on top of plastic risers, not intended to hold up against weed whackers, dogs, kids on bikes, etc. Although there is an application for these components (pots & containers) they do not perform well in a general landscape application. Especially micro spray. Trying to irrigate ground cover with these is asking for trouble; beside the fact that they are not tough enough, the water emitted is a fine mist, half of which blows away. This defeats the purpose of the water saving character of drip systems. Regular sprinklers used sparingly on ground cover is a better bet. Even better than that is the in-line drip tubing often called 'tech line'.

❑ **TECH-LINE / IN-LINE DRIP TUBING:** This is tubing that has emitters infused in the tubing. It can best be thought of as a high-tech soaker hose. The amount of water is controlled by the emitters inside the tubing. It comes in 1/2" and 1/4" diameters. The proper application is a uniform planting – such as large areas of ground cover.



Drip Irrigation - The Basic System

OTHER COMPONENTS:

- ❑ **GOOF PLUGS:** Like it sounds, these little gizmos can plug holes in the main tubing if you change your mind, or make a mistake or your plant dies – easy fix.
- ❑ **HOLD DOWNS:** These are anchors that hold tubing in place. Use wire anchors about every 5 to 6ft on the main line 1/2" tubing. Use the wire anchors or the plastic hold downs to direct the 1/4" tubing and/or emitter to the root zone of the plant. Remember the system only works if the water gets to the root zone of the plant, anchoring the emitters in place will help ensure things stay in place.

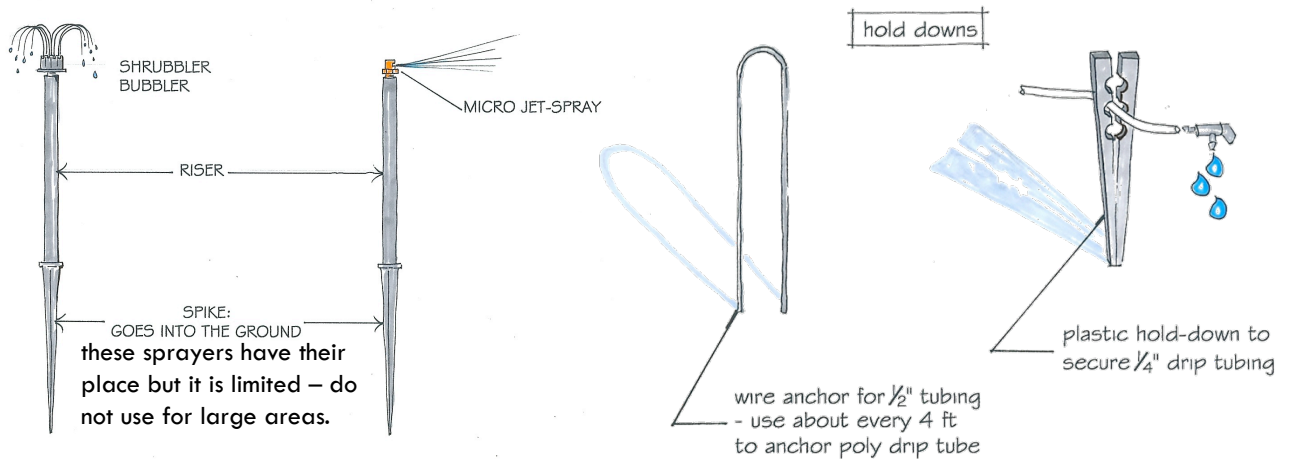

- ❑ **HOLE PUNCH:** You need to punch holes in the tubing to insert emitters.

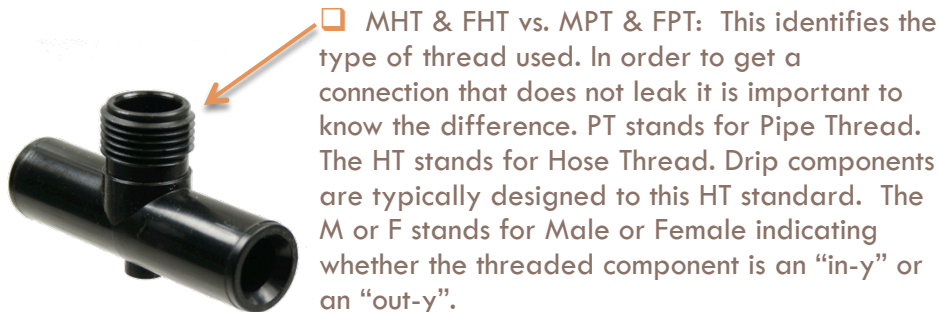

- ❑ **MULCH:** This is the final step in the installation of a drip system. Apply a uniform 3 inch thick layer of medium grind wood mulch over the entire planted area. This does a few things; it covers up the poly tubing on the ground, it minimizes weed growth and conserves moisture.

- ❑ **VALVES OR ZONES:** These terms are interchangeable. It is important to understand that different zones (valve assignments) need to be made up of plant materials with a similar irrigation demand. For example Trees need their own valve – a typical setting for established trees might be irrigating for 6 hours at 2 week intervals. Vegetable gardens may require water almost every day but only for 20 minutes at a run.

Drip Irrigation - Starting at the Valve

- VALVE WITH HARD PIPE (SCH 40) :** Ideally this is the way I would set up a new valve installation for drip – goes back to the build it like a BUICK philosophy. The filter & pressure regulator are added to the valve assembly as shown. From that point, sch 40 irrigation pipe is laid in ditches below grade and stubbed up at locations needed. One valve can be stubbed up in different locations as long as the plantings are all compatible to that one valve. A good example of this would be a valve for trees or one for pots and containers.

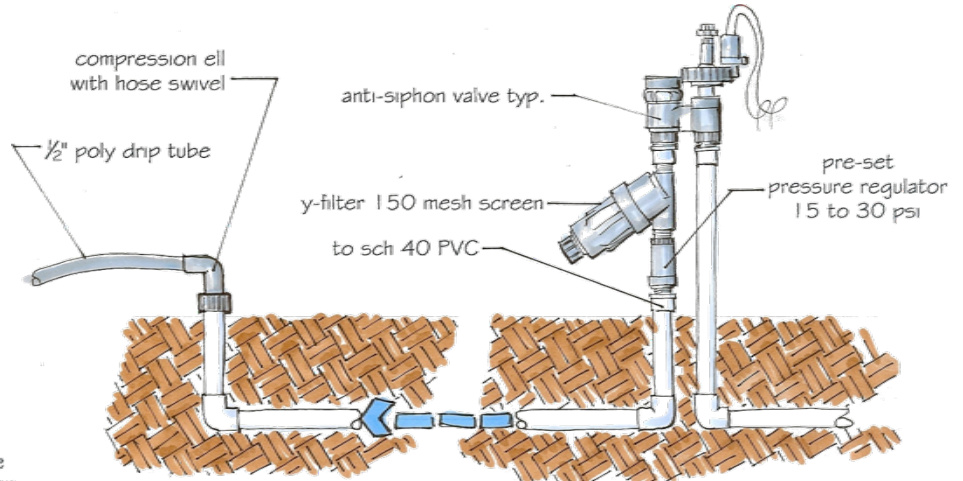

- STUB UP:** Bring the pipe to the location needed. You can do this in more than one location. The sch 40 PVC pipe can be brought up above grade and capped until the final grade is established. When you are ready to connect the irrigation, the pipe is cut and a slip fitting with 3/4 inch MHT is glued on allowing the drip fittings to be connected.

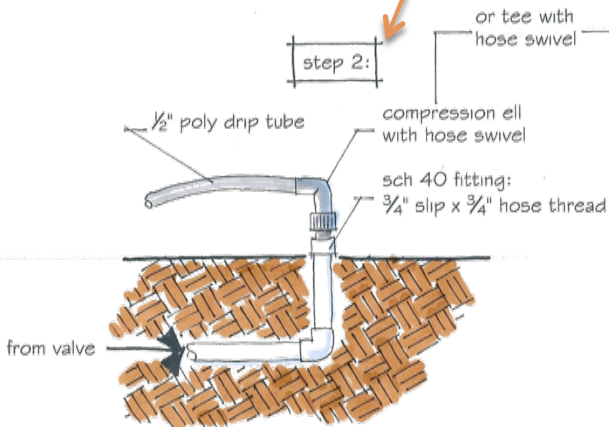
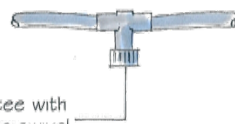
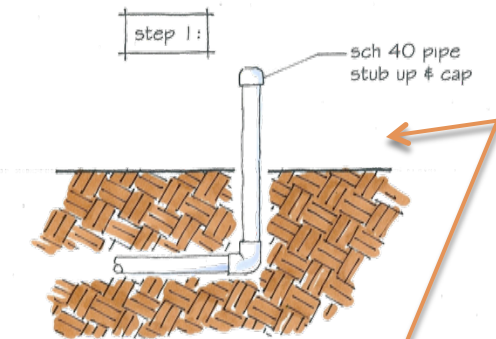

- VALVE WITH DRIP TUBING:** You can also install a valve with poly tubing

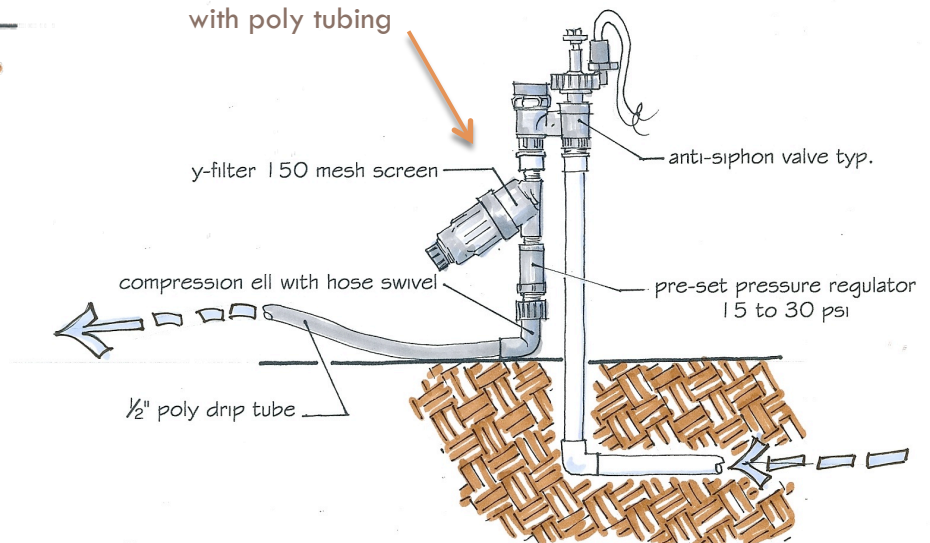

Drip irrigation - Retro-fit the existing sprinkler system

❑ **RETRO-FIT:** Sometimes it is a whole lot easier to just leave the valve alone when switching to drip from an existing sprinkler system. You can add the filter and the pressure regulator downstream from the valve at the site. There are a few ways to do this.

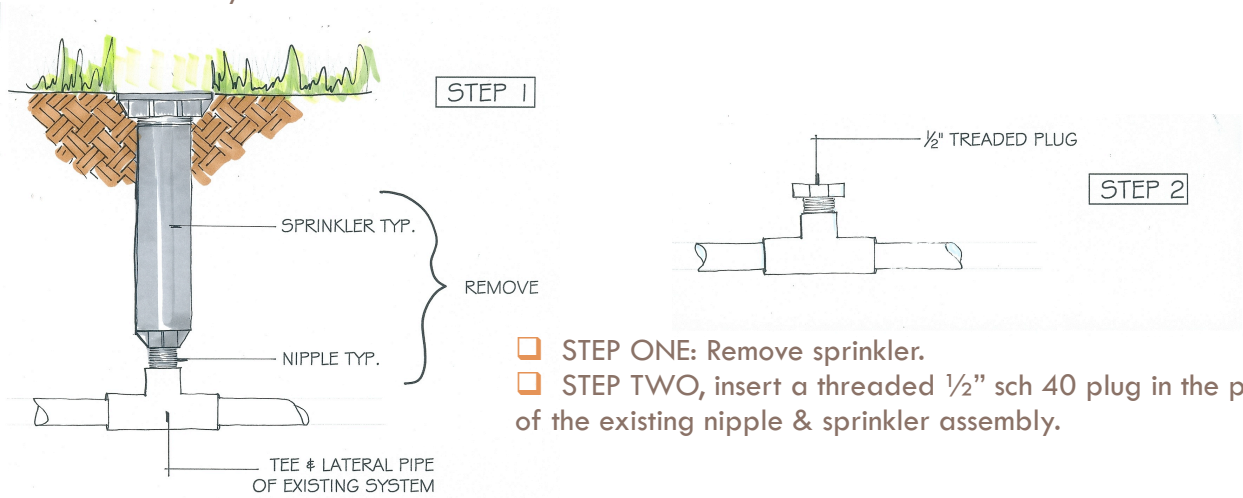

❑ **ANOTHER WAY:** RAINBIRD makes an easy retro-fit kit. You simply remove the "guts" of the sprinkler and replace with a component that includes a pressure regulator & filter that fits right into a 1800 series sprinkler body. In the areas that need to be capped they make a solid cap that screws on – easy.



❑ **CHOOSE A CENTRAL LOCATION FOR THE CONNECTION.** Select one location to connect the new drip system. This is where you will add the pressure regulator and filter assembly. Plug all other locations in the existing sprinkler system.

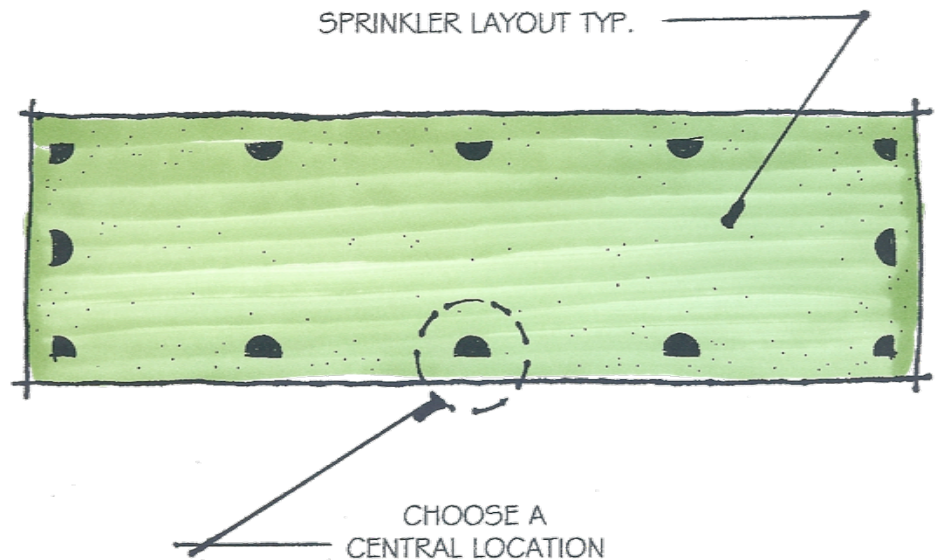

Drip irrigation - Retro-fit the existing sprinkler system

❑ **FITTING AT THE POINT OF CONNECTION:** What I am calling the POC (not technically a 'correct' term but it works for our purpose here) is where the actual drip components connect to the water source – in this case one of the locations where a sprinkler was. With the RAINBIRD retro-fit kit this is done for you. Here is another bullet-proof way to do this. Install in order:

- SCH 80 nipple - 1/2" x length as required
- SCH 40 1/2" ell - TxT
- SCH 40 1/2" MPT x 3/4" MHT transition nipple
- Tee Filter
- Pre-Set Regulator
- Compression fitting with hose swivel connector

Lay this entire assembly on top of grade. Do not bury. **NOTE: IT IS IMPORTANT TO KNOW THAT MOST PRE-SET PRESURRE REGULATORS SHOULD NEVER BE PUT BELOW GRADE IN A VALVE BOX. THEY WILL NOT WORK IF SUBMERGED IN WATER OR MUDDY SOILS**

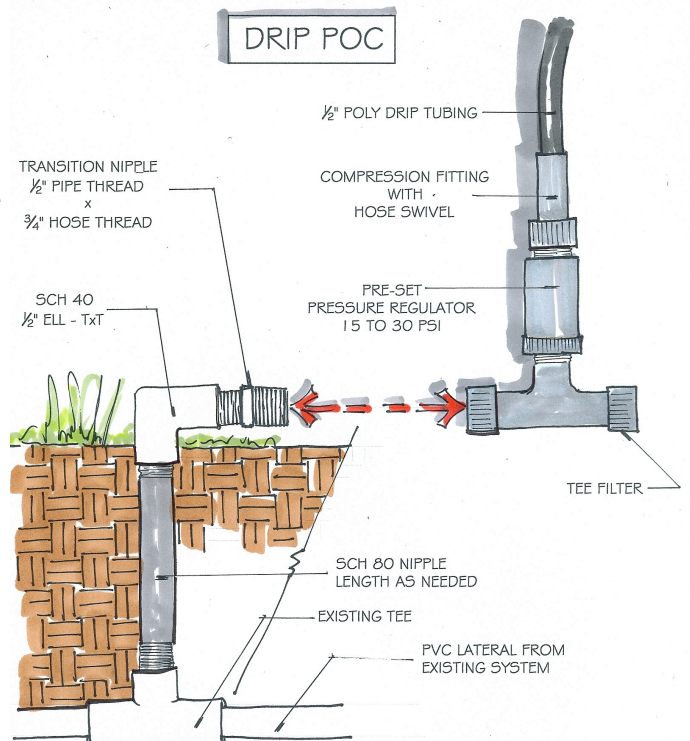

❑ **EMITTERS:** Also called drippers, they regulate the flow of water – from .5 GPH to 4 GPH is typical. Emitters come in a variety of shapes and sizes. I use only 1 GPH drippers in my garden with very few exceptions. I would rather put less water on for a longer period of time – this way I know there is no run off. It is **HIGHLY** advisable not to get too precious with the many different types and flow rates available in the world of drippers & emitters. It becomes a pain maintenance-wise. And I build everything with the end user in mind – in my garden that would be me. Standardize your system by using one type of emitter in one flow rate and stick with that. If you need more water on a particular plant just add another emitter – simple. These days I really like the RAINBIRD xeri-bug emitter.

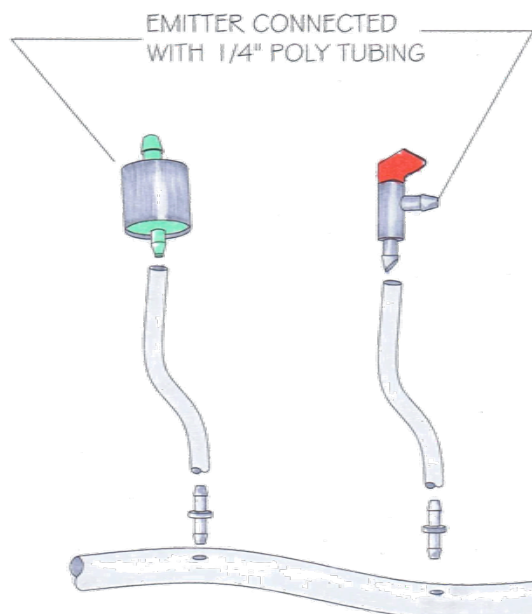

EMITTERS can be connected to the poly tubing in one of two ways as shown in the illustration.

EMITTER CONNECTED DIRECTLY IN THE 1/2" POLY TUBING

Drip irrigation - Other Good Stuff to Know

❑ IRRIGATION TREES: Trees have a basic requirement of deep infrequent irrigation. This is the exact opposite of the conditions required to sustain a turf area. Trees actually will do better if NOT in a lawn. The problem of surface rooting also goes away with the deep watering of a well built drip system. The picture to the right shows what I call a “pig tail”. The main line can run up to 200 linear ft from the water source (if you have a T it can go 200 ft in both directions). The “tail” part of this is the loop that goes around the root zone of the tree. Depending on the size of the tree I will use from 3 to 6 emitters per tree. These are standard emitters, 1 or 2 GPH. The valve will then run for hours depending on the water demand. If you have fruit trees, they will probably want more water than some ornamental trees – so a separate valve could be a good idea, although I grow great Oranges and water my Eucalyptus trees on the same valve.

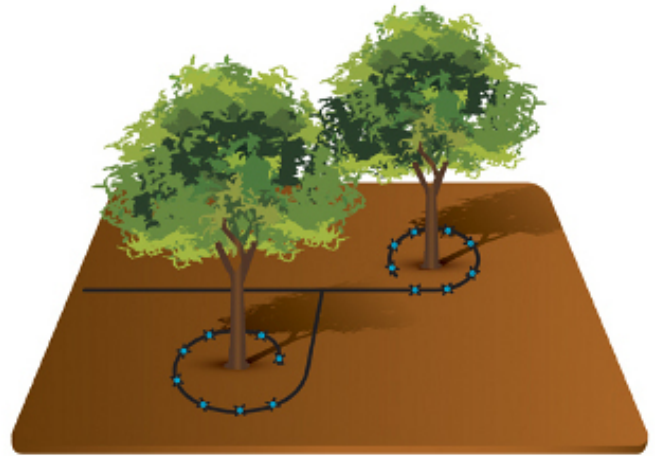

❑ VEGETABLE GARDENS: A good application for the in-line drip tubing - tech line or soaker hose. The great thing about this is that at the end of the season you can pull back the drip line like a blanket and till the soil add compost etc. rake it all out, and lay the tubing back down. Very easy and efficient. I use the 1/4 inch tubing with emitters at a 6" spacing.



close up shows the in-line emitters that are fused into the tubing.



drip line in a raised vegetable bed can be laid back like a blanket allowing clean-up and the addition of amendments, then laid back down.